

# Wear Regimes of Al-Cu-Mg Matrix Composites

R. N. Rao and S. L. Tulasi Devi

**Abstract**—Tribological behavior and wear regimes of ascast and heat-treated Al-Cu-Mg matrix composites containing SiC particles were studied using a pin-on-disc wear testing apparatus against an EN32 steel counterface giving emphasis on wear rate as a function of applied pressures (0.2, 0.6, 1.0 and 1.4 MPa) at different sliding distances (1000, 2000, 3000, 4000 and 5000 meters) and at a fixed sliding speed of 3.35m/s. The results showed that the composite exhibited lower wear rate than that of the matrix alloy and the wear rate of the composites is noted to be invariant to the sliding distance and is reducing by heat treatment. Wear regimes such as low, mild and severe wear were observed as per the Archard's wear calculations. It is very interesting to note that the mild wear is almost constant in all the wear regimes.

**Keywords**—Aluminum, matrix, regimes, wear.

## I. INTRODUCTION

ALUMINUM matrix composites (AMCs) are becoming potential engineering materials offering excellent combination of properties [1-2]. Because of their excellent combination of properties, AMCs have been emerged as advanced materials for several applications in automobile, aerospace, defense and other engineering sectors [2-6]. Indeed, these promising new materials have found wide range of application in automobile industries in the recent years in order to improve the fuel efficiency. Out of different automobile components, AMCs have been found to be a more promising material, in brake drum, cylinder blocks, cylinder liners etc. [1-6]. In aerospace industries, Al composites are used essentially in structural applications such as helicopter parts, rotor vanes in compressors and in aero-engines [5]. The performance of these components is based primarily on their wear and friction characteristics. In recent times, attention is being paid to the use of high strength Al-Cu-Mg alloys for structural applications in aerospace and general engineering sectors etc. Attempts have been made to examine the effect of sliding distance on wear behavior of as cast and heat-treated aluminum alloy composites [5, 6].

As for the mechanical and physical factors (such as sliding velocity and normal load), showed wear mechanism and wear map of MMCs Miyajima et.al [7]. Alpas and Zhang [8] investigated the effect of particle reinforced MMCs under

different applied load and identified three different wear regimes. At low load regime (regime I), the particles support the applied load. The wear resistance of MMCs is in order of magnitude better than aluminum alloy. At regime II, wear rates of MMCs and Al alloy were similar. At high load and the transition to severe wear (regime III), the surface temperatures exceed a critical value. And reinforcements increased the transition load to severe wear. Rao et.al [9] clearly demonstrated the strong interaction between load and sliding velocity in causing wear of a material. Wilson and Alpas [10] represented wear mechanism maps for A356 alloy/SiC composites. According to these investigators, four wear regimes were observed in the composites and the alloy depending on speed and applied load. They are mild wear, mixing and oxidative wear, delamination wear and severe wear. Alpas and Zhang [8] noted three distinct regions of wear as a function of load. In the low load regime, the type of wear is designated as oxidative wear in which the oxide Al surface layer is removed during sliding process. In the medium load regimes, the wear of material is designated as mild wear in which the loss of material is dictated by asperity-to-asperity contact. However, in high load regime, the wear of material is controlled essentially by subsurface deformation and fracturing of the surface as proposed by Suh [11]. In general, it is observed that the wear of the composite is reported less as compared to that of the alloy.

Das et.al [12] demonstrated that the Heat-treated composites were found to possess superior wear properties as compared with those of diecast composites and matrix alloys. Lin et.al [13] reported that the tribological behavior of the composites in the T6 heat-treated condition is better than in the annealed condition or than that of the unreinforced alloy. The wear weight loss is reduced with increasing content of graphite particulates and sliding speed. Hassan et.al [14] demonstrated that the wear loss of the copper containing alloys was less than that for the copper free alloys. It was observed that the volume losses in wear test of Al-Mg-Cu alloy decrease continuously up to 5%. Also it was found that the silicon carbide particles play a significant role in improving wear resistance of the Al-Mg-Cu alloying system. Singh et.al [15] observed that the composite exhibited lower wear rate than that of the matrix alloy. Increasing applied load increased the wear rate. In the case of the composite, the wear rate decreased with speed except at higher pressures at the maximum speed; the trend reversed in the latter case. Jha et.al [16], the effects of varying sliding speed and distance, applied pressure and material characteristics, as well as the amount of graphite, on the dry sliding behaviour have been evaluated. The wear

R. N. Rao, Associate Professor is with the Mechanical Engineering Department, National Institute of Technology, Warangal, A.P., India (phone: 09441569066; fax: +91 8702459547; (e-mail: rraonitw@gmail.com).

S. L. Tulasi Devi, Assistant Professor is with the School of Management, National Institute of Technology, Warangal, A.P., India (phone: 09440545865; fax: +91 8702459547; (e-mail: sltdevi.nitw@gmail.com).

rates of the composites increased with increasing amounts of graphite. Rohatgi et.al [17], the test results showed that the addition of silica sand particles decreased the friction coefficient of Mg modified A206 alloy. The wear rate of the composites increased with increases in the applied pressure and with increases in the silica sand content. The high wear rate may be as a result of an overall decrease of the fracture toughness of the composites containing silica particles. A T6 heat treatment did not significantly decrease the friction coefficient or the wear rate of either the A206 matrix alloys or the composite containing silica sand. Acilar and Gul [18] reported that the volumetric wear rate increased with increasing sliding distance and increasing applied load. Oxidation of SiC<sub>p</sub> was been effective on the wear resistance of the composites. Suresha and Sridhara [19] demonstrated that the load and sliding distance show a positive influence on wear implying increase of wear with increase of either load or sliding distance or both. Whereas speed shows a negative influence on wear indicating decrease of wear with increase of speed. Interactions among load, sliding speed and sliding distance are noticed in hybrid composites and this may be attributed to the addition of Gr particulates. Such interactions are not present in composite reinforced with SiC alone.

In view of the above, in the present study, Al-Cu-Mg alloy and Al-Cu-Mg-SiC particle composite in ascast and heattreated conditions have been examined under varying sliding distance and at different applied pressures.

## II. EXPERIMENTAL PROCEDURE

### A. Material Preparation

Al-Cu-Mg alloy and Al-Cu-Mg-SiC particle composites have been used for the present study and the chemical composition of the matrix alloy is shown in Table I. The composite was synthesized through solidification processing (stir-casting) route using SiC particles with volume fraction of 10wt.% of size range 20-40 $\mu$ m as reinforcement.

TABLE I  
CHEMICAL COMPOSITIONS OF THE ALUMINIUM ALLOY (IN WT.%)

Element (wt.%)	Fe	Cu	Mn	Mg	Zn	Al
Al-Cu-Mg	0.49	4.46	0.59	1.86	0.034	Rest

### B. Microscopy

For microstructural examinations, samples were cut from the cast disc 20 mm in diameter and 15mm thick, polished metallographically using standard metallographic technique and finally etched with Kellor's reagent (1% HF, 1.5% HCl, 2.5% HNO<sub>3</sub> and remaining water). Etched samples were examined under scanning electron microscope (model: JEOL, JSM-5600). The samples were sputtered with gold prior to scanning electron microscopic examination.

### C. Heattreatment

The alloy and composite are heattreated in a Muffle electric furnace. Three stages involved during heat treatment

of the investigated material are: (i) Solution treatment: the alloy or composite are heated for 8 hours at a temperature of 490°C until the alloying solute elements are completely dissolved in Al solid solution, (ii) Quenching: the solution treated material is cooled rapidly in the water to prevent the precipitation of the solute elements and to obtain a super saturated solid solution and (iii) Artificial aging: hardening can be done by reheating the quenched alloy to a temperature of 180°C, 6 hours in order to get the better properties.

### D. Sliding Wear Test

Sliding wear tests were conducted in pin-on-disc wear testing apparatus (model: TR20-LE, Ducom Make, Bangalore, India) under varying applied loads at a fixed sliding speed of 3.35 m/s against steel disc of hardness 500HV. The pin samples were 27mm in length and 8mm in diameter. The surfaces of the pin sample and the steel disc were ground using emery paper (grit size 240) prior to each test. A set of pins was subjected to running-in-wear at an applied load of 10N (applied pressure 0.2MPa) up to a sliding distance of 5000m against the steel disc at a speed of 3.35 m/s. In order to ensure effective contact of fresh surface with the steel disc, the fresh samples were subjected to sliding on emery paper of 240 grit size fixed on the steel disc. During sliding, the load is applied on the specimen through cantilever mechanism and the specimens brought in intimate contact with the rotating disc at a track radius of 65mm (Fig. 1) The samples were cleaned with acetone and weighed (up to an accuracy of 0.01 mg using microbalance) prior to and after each test. The wear rate was calculated from the weight loss measurement and expressed in terms of volume loss per unit sliding distance. The temperature rise and friction force were recorded from the digital display interfaced with the wear test machine.

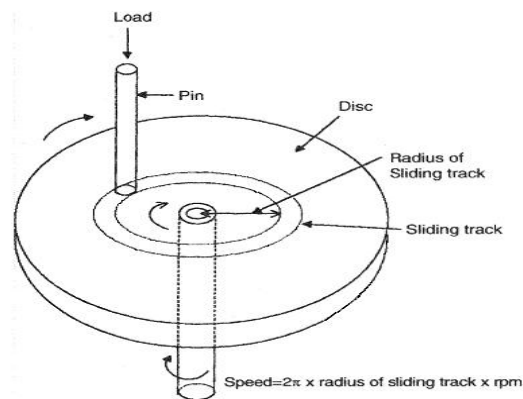
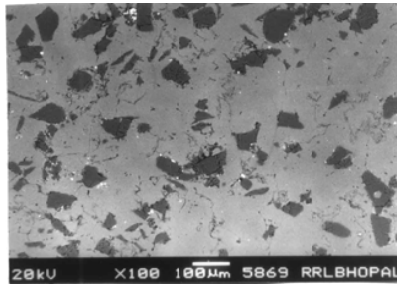

Fig. 1 Schematic diagram of pin-on-disc test set up

## III. RESULTS

Fig. 2 (a) represents a typical microstructure of composite exhibiting uniform distribution of SiC particle in the alloy matrix. A Higher magnification micrograph of composite indicates good interface bonding between particle and the matrix (Fig. 2(b)).



(a)

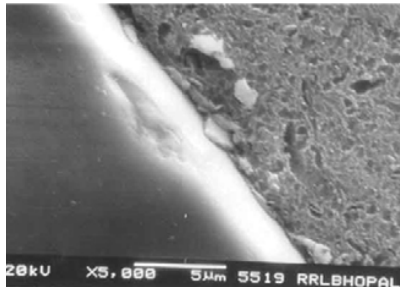

(b)

Fig. 2 Microstructure of (a) uniform distribution of particles in matrix and (b) good interface bonding between particle and matrix

The wear rate of as cast aluminum alloy and composites are plotted as a function of sliding distance tested at a velocity of 3.35 m/s and at different applied pressures (Fig. 3). Fig. 3 (a) represents the variation of wear rate with applied pressure for a fixed sliding distance of 1000 meters. It is noted that the wear rate is increasing with applied pressure in all the cases, but there is no significant improvement at the mild wear regime. The wear rate of the alloy is more in all the cases except 5000m at low load regime. It is very interesting to observe that almost the rate of wear is constant at mild wear regime except 5000m. The rate of wear is suppressed due to addition SiC particle as well as heattreatment. The wear resistance of the alloy is improved significantly due to reinforcement of SiC particle. It is further noted that the wear rate of composite decreased simply by heattreatment. The wear rate of the composite is noted to be lying in a narrow band. For example, the wear rate of the alloy at different applied pressures (0.2, 0.4, 1.0 and 1.4) at fixed sliding distance of 1000 meters are 1.75, 1.858, 1.97 and  $2.82 \times 10^{-12}$  m<sup>3</sup>/m respectively. Similarly for heatreated alloy, the wear rate at a distance of 1000 m are 1.51, 1.81, 1.94 and  $2.68 \times 10^{-12}$  m<sup>3</sup>/m respectively. It is observed that the rate of wear is decreasing simply by heattreatment. The wear rate of 10 wt.% composite and composite heattreated at a distance of 1000 m at 0.2 MPa are noted to be  $1.02 \times 10^{-12}$  m<sup>3</sup>/m and  $0.9 \times 10^{-12}$  m<sup>3</sup>/m respectively. Fig. 3 (b), (c) and (d) are similar to Fig 3(a) and follow the similar trend. Fig. 3(e) shows some different characteristics for the alloy. It is noted that the wear rate of the alloy increased significantly when the pressure changed from 0.2 to 0.4 MPa. This is primarily due to the occurrence

of seizure. The wear rate of the composites is noted to be invariant to the sliding distance and is reducing with heattreatment. This figure also indicates that the alloy seized at a sliding distance of 4000 m when the applied pressure is 1.4 MPa and sliding velocity is 3.35 m/s. But under such condition, composite material did not seize even at a sliding distance of 5000 m. Comparison all the figures; it clearly indicates that wear rate is increased with increase in applied pressure.

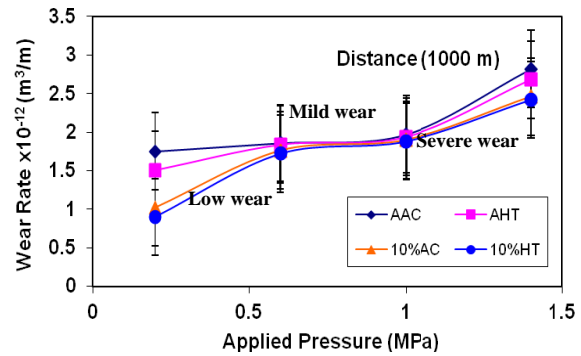

(a)

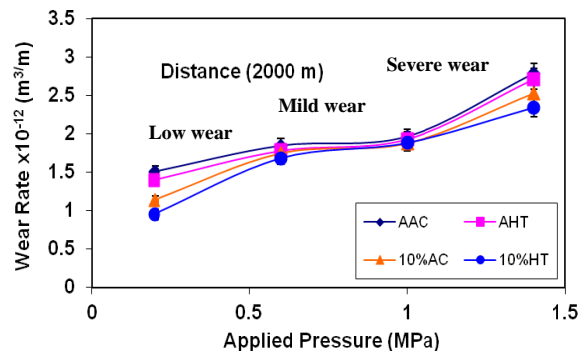

(b)

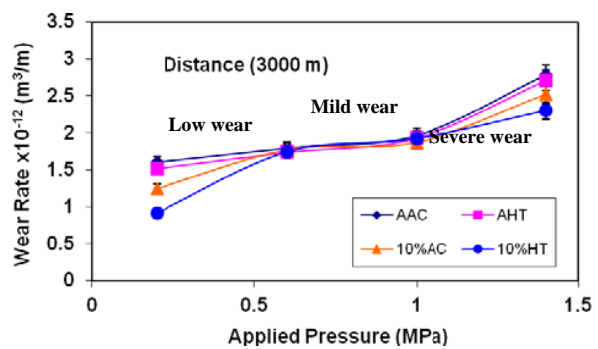

(c)

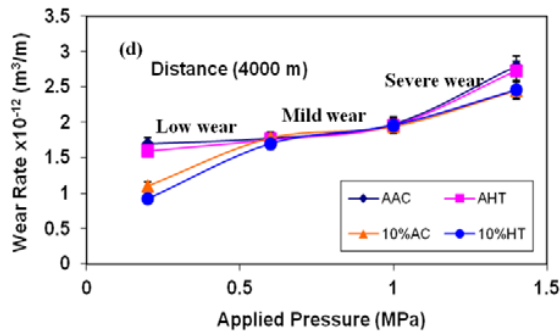

(d)

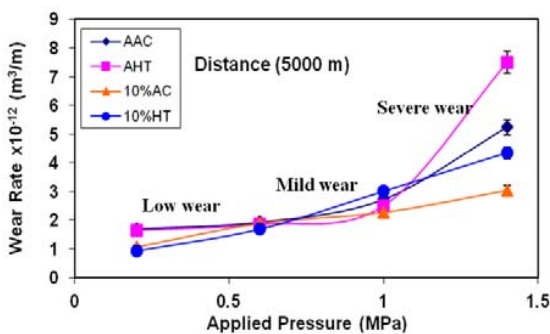

(e)

Fig. 3 Wear rate vs. applied pressure diagram for alloy and composite (a) Distance: 1000 m (b) Distance: 2000 m (c) Distance: 3000 m (d) Distance: 4000 m and (e) Distance: 5000 m; (Sliding Velocity : 3.35 m/s)

#### IV. DISCUSSION

Wear volume of a material as a function of hardness and applied pressure is expressed by Archard's [20] wear equation

$$Q = KW/H \quad (1)$$

Where  $Q$  = volume removed from the surface by wear per unit sliding distance,  $H$  = indentation hardness of the softer surface,  $W$  = normal pressure applied between the surface,  $K$  is Archard's wear coefficient is dimensionless always less than unity. The value of  $K$  provides valuable means of comparing severity of different wear processes. For sliding wear of metals typical values of  $K$  for the mild wear of metals are  $10^{-4}$  to  $10^{-6}$ , while  $K$  becomes  $10^{-3}$  to  $10^{-2}$  for severe wear.

Sliding wear is related to asperity to asperity contact. In the initial stage asperities of the softer materials get deformed or fractured and as time progressed there is a possibility of obtaining smoother surface. It is also reported that material from the softer surface may be transferred to the harder one and vice versa. Thus, with increasing in sliding distance effective contact area, surface roughness and surface chemistry etc. changes, which lead to variation in wear rate with sliding distance. However, different kinds of trend of variation in wear with sliding distance is reported by

different investigators [8-12]. Wang and Rack [21] observed that mixed behavior of wear rate of AMCs with sliding distance depending on speed, type and orientation of reinforcement. According to these investigation AMCs exhibit steady state wear rate within the entire range of sliding distance (up to 3000 m) when the sliding speed is less than 0.36 m/s. At higher sliding speed they examined unsteady state wear rate up to sliding distance of 1000m. On the contrary, the alloy exhibit steady state wear rate irrespective of the sliding speed. Wilson and Alps [10] also examined unsteady wear rate followed by a steady state wear rate. But the critical distance i.e. the transition from unsteady state to steady state depends on the applied load. Abrasion due to entrapped ceramic particles or harder debris from counter steel part leads to severe wear but after a critical sliding distance, formation of transferred layer and its subsequent deformation is the dominating wear mechanism. At slower speed, abrasion induced wear mechanism is dominating due to less rise in temperature and thus less possibility of formation of transferred layer over the specimen (Oxide layer or mixed layer). Lower steady state wear rate may also be due to subsurface work hardening. Thus fracture and fragmentation of transferred layer and subsurface cracking greatly control the steady state wear. How and Baker [22] reported steady state wear rate decreases with sliding distance in AA 6061-10vol.% saffil fibre composites irrespective of applied load. Similar behaviour was also reported by Sannino and Rack [23] in Al 2001- 20vol. % SiCp composite. This is attributed to the fact that delamination of subsurface layers generating loose debris which gives turbulent friction at the interfaces and this may be the dominating wear mechanism. However, after prolonged duration transferred layer may be discontinued and locally fused to cause adhesion kind of wear. Because of combined action of load, sliding speed and sliding distance subsurface micro cracks are generated which finally leads to removal of wear debris. As a result, it is expected that the wear rate will increase with increase in sliding distance. However, as the sliding distance increases the subsurface deformation also increases which leads to alignment of stronger precipitates along the sliding direction. With further increase in sliding distance, the temperature rise increases to a critical value at which specimen surface gets oxidized. This oxidized surface either gets fragmented or become stable to some extent. The fragmented oxide particles sometimes act as lubricating agent and thus these oxide layers reduce the effective wear rate. Furthermore the fragmentation and compaction of wear debris, counter surface material and thin oxide layers leads to formation of mechanically mixed layer which protects the specimen surface from wear. However, further increasing sliding distance leads to increasing temperature which leads to subsurface softening and because of plastic incompatibility and thermal mismatch the mechanically mixed layer (MML) gets fractured and subsequently removed from the specimen surface. Thus at longer sliding distance it is expected that the formation and removal of MML is taking place simultaneously and the rate

of removal and the rate of growth of MML might be same and thus the wear rate remain unchanged with sliding distance. At the point of seizure the MML either becomes unstable because of greater degree of temperature rise in the subsurface which resulting in higher degree of thermal as well as plastic incompatibility between MML and subsurface. As a result, the MML gets widely fractured and subsequently removed leading to exposure of highly viscous subsurface materials, which gets adhered with the counter surface. This leads to sudden increase in wear rate, which is identified as seizure or onset of seizure of the specimen.

#### V.CONCLUSIONS

The wear rate of the alloy and composite are varying with applied pressure. The rate of wear of the composite is suppressed due to addition of SiC. The rate of wear was also low in case of alloy and composite for further heat treatment. As per Archard's wear equation three wear regimes were identified such as low, mild and severe wear. At low load conditions (low wear regime), the SiC particles support the applied load. The wear resistance of composite is in order of magnitude better than alloy. At medium load condition, the rate of wear of alloy and composites were showing similar behavior. At higher load condition, the transitions to severe wear showing different characteristics at the onset of seizing of the sample.

#### REFERENCES

- [1] D.J. Lloyd. Particle reinforced aluminium and magnesium matrix composites. *International Materials Review*; vol.39, pp.1-23, 1994.
- [2] P.K. Rohatgi. Cast aluminum matrix composites for automotive applications, *JOM*, pp.10-15,1991.
- [3] Nitsham AE. New application for Al based MMC. *Light metal age*, vol. 53, pp. 54, 1997.
- [4] S. Das Development of aluminium alloy composites for engineering applications. *Trans. Indian Inst. Met.*, 57, pp. 325-334, 2004.
- [5] R.S. Rawal Metal matrix composites for space applications. *JOM*, vol.14, 2001.
- [6] R.N. Rao, S. Das, D.P. Mondal, G. Dixit, Dry sliding wear behaviour of cast high strength aluminium alloy (Al-Zn-Mg) and hard particle composites. *Wear*, vol. 267, pp. 1688-1695, 2009.
- [7] T. Miyajima, Y. Iwai, Effects of reinforcements on sliding wear behavior of aluminum matrix composites, *Wear*, vol. 255, pp. 606-616, 2003.
- [8] A.T. Alpas and J.Zhang, *Scripta Metall*, vol.26, pp.505,1992.
- [9] R.N. Rao, S.Das, D.P.Mondal, G.Dixit, S.L.Tulasi Devi, Dry sliding wear maps for AA 7010(Al-Zn-Mg-Cu) Aluminium matrix composite, *Tribology International*, vol. 60,pp. 77-82, 2013.
- [10] Wilson S. and Alpas A.T. Thermal effects on mild wear transitions in dry sliding of an aluminium alloy, *Wear*, vol.225-229, pp.440-449, 1999.
- [11] N.P. Suh, *Fundamentals of Tribology*, Ed: N.P. Suh and N Saka, The MIT Press, Cambridge, 443.
- [12] S.Das, S.V.Prasad T.R. Ramachandran, Microstructure and wear of cast (Al-Si alloy)-graphite composites. *Wear*, vol.133, pp.173-187, 1989.
- [13] C.B. Lin, R.J. Chang, W.P.Weng, A study on process and tribological behavior of Al alloy/Gr. (p) composite. *Wear*, vol.217, pp.167-174, 1998.
- [14] Hassan Adel Mahamood, Alrashdan Abdalla, T. Hayajneh Mohammed Mayyas Ahmad Turki. Wear behavior of Al-Mg-Cu-based composites containing SiC particles *Tribology International*, vol.42, pp.1230-1238, 2009.
- [15] M.Singh, B.K. Prasad, D.P.Mondal, A.K. Jha. Worn surface, Dry sliding wear behaviour of an aluminium alloy-granite particle composite. *Tribology International*, vol.34, pp.557-567,2001.
- [16] A.K. Jha, S.V. Prasad, G.S. Upadhyaya, Worn surface, Dry sliding wear of sintered 6061 aluminium alloy-graphite particle composites, *Tribology International*, vol.22,pp.321-327,1989.
- [17] P.K Rohatgi, B.F. Schultz, A. Daoud, W.W. Zhang, Tribological performance of A206 aluminum alloy containing silica sand particles, *Tribology International*, vol.43, pp.455-466,2010.
- [18] Acilar Mehmet, Gul Ferhat. Effect of the applied load, sliding distance and oxidation on the dry sliding wear behaviour of Al-10Si/SiC<sub>p</sub> composites produced by vacuum infiltration technique. *Mater Des*;vol 25, pp. 209-217, 2004.
- [19] S. Suresha, B.K. Sridhara. Effect of silicon carbide particulates on wear resistance of graphitic aluminium matrix composites. *Mater Des*; vol.31,pp.4470-4477, 2010.
- [20] J.F. Archard, Contact and rubbing of flat surfaces. *J. Appl. Phys.*, vol.24,pp.981-988, 1953.
- [21] A.Wang and H.J, Rack Abrasive wear of silicon carbide particulate and whisker-reinforced 7091 aluminium matrix composites, *Wear*, vol.146,pp.337-348,1991.
- [22] H.C. How, T.N.Baker, Characterization of sliding friction-induced subsurface deformation of Saffil-reinforced AA6061 composites. *Wear*, vol.232,pp.115, 1999.
- [23] A.P. Sannino, and H.J. Rack, *Wear*, vol.197,pp.151, 1996.