

# Variable vs. Fixed Window Width Code Correlation Reference Waveform Receivers for Multipath Mitigation in Global Navigation Satellite Systems with Binary Offset Carrier and Multiplexed Binary Offset Carrier Signals

Fahad Alhussein, Huaping Liu

*Abstract*—This paper compares the multipath mitigation performance of code correlation reference waveform receivers with variable and fixed window width, for binary offset carrier and multiplexed binary offset carrier signals typically used in global navigation satellite systems. In the variable window width method, such width is iteratively reduced until the distortion on the discriminator with multipath is eliminated. This distortion is measured as the Euclidean distance between the actual discriminator (obtained with the incoming signal), and the local discriminator (generated with a local copy of the signal). The variable window width have shown better performance compared to the fixed window width. In particular, the former yields zero error for all delays for the BOC and MBOC signals considered, while the latter gives rather large nonzero errors for small delays in all cases. Due to its computational simplicity, the variable window width method is perfectly suitable for implementation in low-cost receivers.

*Keywords*—Correlation reference waveform receivers, binary offset carrier, multiplexed binary offset carrier, global navigation satellite systems

## I. INTRODUCTION

**M**ULTIPATH is the main source of error in satellite communications [1]–[3], and it is due to the interference from delayed versions of the signal that are received in addition to the same signal arriving in a direct-path from the transmitter. The techniques for multipath mitigation can be one of three types: (i) techniques that use the radiation pattern of the antennas [4], (ii) techniques in the navigation stage without estimating the channel [5], and (iii) techniques in the navigation stage that use channel estimation [5]. The main challenge is to mitigate its effect using low-cost receivers.

As part of the evolution of Global Navigation Satellite Systems (GNSS) during the last two decades, the Early-Late (E-L) receivers that use Binary Phase Shift Keying (BPSK) CDMA modulation with multiplexing [1]–[3], have been replaced by Code Correlation Reference Waveform (CCRW) receivers employing Binary Offset Carrier (BOC) modulations. CCRW receivers are capable of overcoming limitations of E-L, such as the occurrence of false locks in the presence

of multipath, which result in errors in the calculation of the signal travel time [6], [7].

The CCRW receiver was proposed by Young et al. [6], and uses one of six correlation techniques: narrow correlator,  $W_1$ ,  $W_2$ ,  $W_3$ ,  $W_4$  or Gated E-L CCRW [6]. On the other hand, BOC( $m, n$ ) modulation was developed by Betz et al. [3], [10]–[12] and incorporates a square subcarrier to the satellite original Binary Phase Shift Keying (BPSK) signal; this square subcarrier is obtained as the sign function of a sinusoidal signal. In addition to being effective in multipath mitigation, BOC modulation has been used to correct errors in the received information, taking advantage of its redundancy around the central frequency of the channel, and has shown to be robust in the presence of noise [1], [3], [10]–[12].

BOC( $kn, n$ ) modulations are utilized for military (fewer users, high precision required) purposes in the L1 and L2 bands of the GPS system, and in the E1 and E6 bands of the GALILEO system [1], [7], [8]. Later, multiplexed BOC (MBOC) modulations were developed in 2006 to increase the amount of information that can be transmitted, thus facing the massive civilian (many users, lower precision) use of GNSS systems. MBOC modulations include Time multiplexed BOC (TMBOC(6, 1, 4/33)) in the carrier of the L1C band of the GPS system, and Composite BOC (CBOC(6, 1, 1/11)) in the carrier of the E1 OS band of the GALILEO system. MBOC signals were also designed to guarantee high interoperability between both systems [1].

In CCRW receivers, the use of windows  $W_1$ ,  $W_2$ ,  $W_3$  and  $W_4$  (and combinations) to mitigate the effect of multipath has been evaluated for BOC [13]–[19] and MBOC [19]–[22] modulations. These works mainly search for the appropriate shape and width of the pulses, considering that a shorter pulse will be better for multipath mitigation, but will tend to reduce the number of satellites “seen” by the receiver [23]. Specifically, this has been formulated as an inverse problem [13]–[22]: given a desired discriminator, find the correlation functions that generate it, and further find the windows that will result in those correlation functions. Algorithms for solving such inverse problems may be time consuming and computationally demanding, and thus not appropriate for implementation in low-cost receivers [23]. A more rigorous

Fahad Alhussein and Huaping Liu are with School of Electrical Engineering and Computer Science, Oregon State University, Corvallis, USA (e-mail: alhussef@oregonstate.edu, huaping.liu@oregonstate.edu).

mathematical analysis of such inverse problems is presented in [24]–[27].

As a more effective alternative, AlHussein et al. [23] proposed a method of variable window width in a CCRW receiver, which will mitigate the effect of multipath of any delay. Such width was iteratively reduced, until finding the first value for which the distortion produced by multipath was eliminated. The proposed approach was tested for BOC( $kn, n$ ) modulation, with  $k = 1$  and  $k = 2$ , using the windows and the receiver proposed by L. Zhe [17], and resulted in zero error for multipath of any delay, thus outperforming those which, in general, exhibit a nonzero error for small delays.

This work compares the multipath mitigation performance of CCRW receivers with variable window width proposed in [23] and fixed window width proposed by Zhe [17], [19], [21], for different BOC and the multiplexed BOC (MBOC) modulations CBOC(6, 1, 1/11) and TMBOC(6, 1, 4/33).

The rest of the paper is structured as follows. Section II describes the BOC and MBOC signals in GNSS. Section III presents the CCRW receiver with fixed window width, while section IV describes the receiver with variable window width. Finally, Section V presents the results and Section VI concludes the paper.

## II. BOC, CBOC AND TMBOC SIGNALS IN GNSS

The BOC( $kn, n$ ) signal is generated modulating a BPSK signal with a square wave sub-carrier of frequency  $nkf_0$  ( $f_0 = 1.023$  MHz). The BPSK signal is obtained modulating the PRN code with a 50 Hz binary signal containing the satellite data. On the other hand, the subcarrier is obtained as the sign of a sine (sine-phased BOC) or a cosine (cosine-phased BOC) waveform [1]. In other words, the sine-phased BOC signal is given by

$$\text{BOC}(kn, n) = c_i(t) \cdot \text{sign} \left( \sin(2\pi nk f_0 t) \right) \quad (1)$$

where  $c_i(t)$  is the BPSK signal [23]. Figs. 1 (a)-(c) show GNSS BOC( $kn, n$ ) signals with a length of four chips, for  $k = 1, 2$  and 6. BOC( $2n, n$ ) is used as a military signal, while BOC( $n, n$ ) and BOC( $6n, n$ ) are used as civilian signals in the MBOC modulation of the GPS system. These signals are summarized in Table I. The signals CBOC(6, 1, 1/11) and TMBOC(6, 1, 4/33) are now described.

TABLE I  
SUMMARY OF BOC AND MBOC SIGNALS USED IN GNSS

Modulation	Service	Band	System
BOC <sub>sin</sub> (10, 5)	L1M-code	L1	GPS
TMBOC(6, 1, 4/33)	L1C	L1	GPS
CBOC(6, 1, 1/11)	E1 OS	E1	GALILEO
BOC <sub>cos</sub> (15, 2.5)	PRS	E1	GALILEO
BOC <sub>cos</sub> (10, 5)	E6 PRS	E6	GALILEO

### A. CBOC(6, 1, 1/11) Modulation

The CBOC modulation was developed by the CNES research group at the University FAF Munich. The

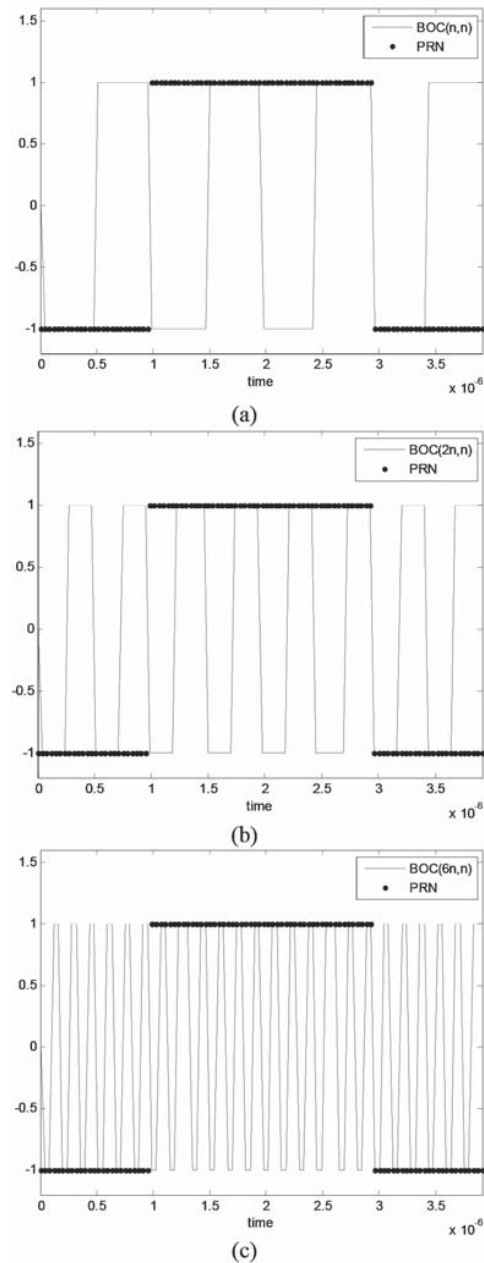


Fig. 1 BOC signals with a length of 4 chips: (a) BOC( $n, n$ ) (b) BOC( $2n, n$ ) (c) BOC( $6n, n$ )

CBOC(6, 1, 1/11) signal is used in GALILEO, and is given as the sum of signals BOC(1, 1) and BOC(6, 1) with different amplitudes, such that their interference generates an appropriate Power Spectral Density (PSD). Specifically, the CBOC(6, 1, 1/11) signal is given by [1]:

$$z(t) = \left[ C_D(t)d(t)(P \cdot x(t) + Q \cdot y(t)) + C_P(t)(P \cdot x(t) - Q \cdot y(t)) \right] \quad (2)$$

where  $z(t)$ ,  $x(t)$  and  $y(t)$  are the CBOC(6, 1, 1/11), BOC(6, 1) and BOC(1, 1) signals, respectively,  $C_D$  is the

data-spreading code sequence,  $C_P$  is the pilot-spreading code sequence,  $d$  is the navigation message, and  $P = \sqrt{1/11}$  and  $Q = \sqrt{10/11}$  are the weight factors of BOC(6, 1) and BOC(1, 1), respectively. The sign inversion of the BOC(6, 1) sub-carrier between the data and pilot channels in (2), cancels the BOC(1, 1)/BOC(6, 1) crossterms which appear on each channel [1].

In this work, the simplified version

$$z(t) = P \cdot x(t) + Q \cdot y(t) \quad (3)$$

of the CBOC(6, 1, 1/11) is used, which considers the high- and low-frequency signals in one chip, without including the data signal. Fig. 2 displays a CBOC(6, 1, 1/11) signal with a length of four chips.

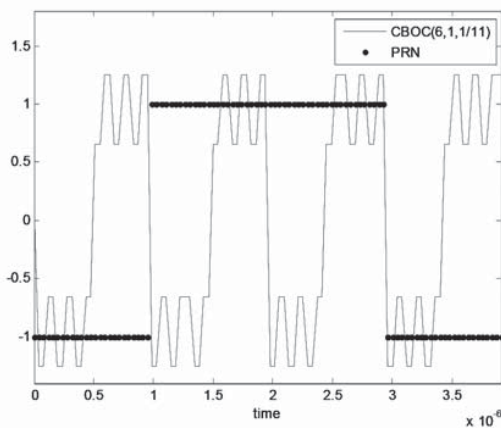


Fig. 2 CBOC(6, 1, 1/11) signal with length of 4 chips

### B. TMBOC(6, 1, 4/33) Modulation

The GPS system adopted the MBOC modulation TMBOC(6, 1, 4/33), which is obtained by multiplexing in time the high frequency signal BOC(6, 1) in the first 4 chips and the low-frequency signal BOC(1, 1) in the last 29 chips of a frame of 33 chips, i.e.

$$z(t) = \begin{cases} c(t) \cdot x(t) & t \in \frac{4}{33} \text{chips} \\ c(t) \cdot y(t) & t \in \frac{29}{33} \text{chips} \end{cases} \quad (4)$$

where  $z(t)$  is TMBOC(6, 1, 4/33) signal,  $c(t)$  is the data, and  $x(t)$  and  $y(t)$  are the BOC(6, 1) and the BOC(1, 1) signals, respectively. Fig. 3 shows chip 3 to chip 6 of a signal TMBOC(6, 1, 4/33) i.e., two before and two after the change in the multiplexed signal.

### III. CCRW RECEIVERS WITH FIXED WINDOW WIDTH

Code Correlation Reference Waveform (CCRW) refers to different code correlation techniques used by some major GPS receiver manufacturers. These techniques were specially designed to mitigate multipath, and use a reference waveform instead of a replica of the navigation signal [23].

CCRW are simple low-cost receivers designed to construct a discriminator that eliminates the ambiguity generated by the

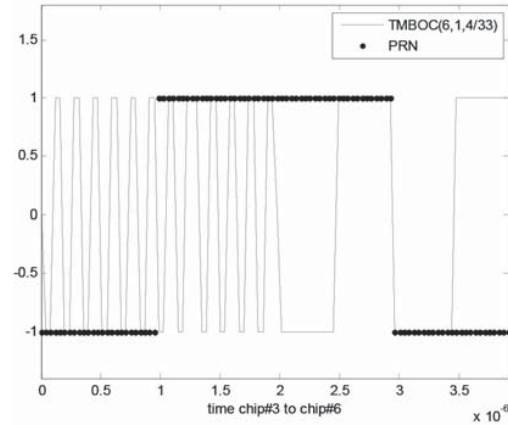


Fig. 3 TMBOC(6, 1, 4/33) signal with length of 4 chips

use of BOC modulation and by the presence of multipath. They contain filters and correlation blocks that result in an adequate interaction between the BOC signals and the stroboscopic windows to mitigate the effect of multipath.

Zhe [19] proposed a CCRW receiver for MBOC( $kn, n, p$ ) signals. This receiver is a modified version of the one described in [23]. Specifically, the incoming MBOC signal is not correlated with its local version, but with an additional stroboscopic window called  $BRW(t)$ . As a consequence, the ambiguities generated by the MBOC signal are located at the extremes of the pull-in region. Therefore, the algorithm for generating the discriminator for MBOC signals comprises the following steps:

Step 1. Generate a BPSK signal  $y(t)$  using the Double Side Band (DSB) method [4], [28], according to which two pass-band filters of aperture  $2 \cdot n \cdot f_0$  are employed. This BPSK signal corresponds to the PRN code modulated in the BOC signal, and has an in-phase component  $y_i(t)$  and a quadrature component  $y_q(t)$ .

Step 2. Construct window  $W$  as

$$W(t) = \sum_{i=0}^{\infty} g(t - iT_C) c_i(t) \quad (5)$$

where

$$g(t) = \begin{cases} 1, & -\frac{T_C}{2k} \leq t < -\frac{T_C}{4k} \\ -1, & -\frac{T_C}{4k} \leq t < 0 \\ 1, & 0 \leq t < \frac{T_C}{4k} \\ -1, & \frac{T_C}{4k} \leq t < \frac{T_C}{2k} \\ 0, & \text{else} \end{cases} \quad (6)$$

and  $c_i(t)$  is a local version of the PRN code.

Step 3. Correlate the in-phase component  $s_i(t)$  and quadrature components  $s_q(t)$  of the incoming BOC signal with

$W(t)$  to obtain

$$I_{\widehat{XW}} = \text{corr}(s_i(t), W_2(t - \varepsilon)), \quad (7a)$$

$$Q_{\widehat{XW}} = \text{corr}(s_q(t), W_2(t - \varepsilon)). \quad (7b)$$

Step 4. Construct the BRW window as

$$\text{BRW}(t) = \sum_{i=0}^{\infty} g_{\text{BRW}} \left( t - iT_C + \frac{T_C}{2} \right) c_i(t) \quad (8)$$

where

$$g_{\text{BRW}}(t) = \begin{cases} -1, & -\frac{G_{BW}}{2} \leq t < 0 \\ 1, & 0 \leq t < \frac{G_{BW}}{2} \\ 0, & \text{else} \end{cases} \quad (9)$$

where  $G_{BW}$  is the width of the stroboscopic pulse.

Step 5. Correlate  $y_i(t)$  and  $y_q(t)$  with the local version  $\text{BRW}(t - \varepsilon)$  of the BOC signal to obtain

$$I_{\widehat{XB}} = \text{corr}(y_i(t), \text{BRW}(t - \varepsilon)), \quad (10a)$$

$$Q_{\widehat{XB}} = \text{corr}(y_q(t), \text{BRW}(t - \varepsilon)). \quad (10b)$$

Step 5. Determine the discriminator by means of the equation

$$d(\varepsilon) = I_{\widehat{XW}}(\varepsilon)I_{\widehat{XB}}(\varepsilon) + Q_{\widehat{XW}}(\varepsilon)Q_{\widehat{XB}}(\varepsilon) \quad (11)$$

Note that: (i) the discriminator is a function of the delay (given in chips) and (ii) the signal mainly corresponds to the in-phase component (the quadrature component is neglected since the angle of the error is approximately zero). Fig. 4 is a plot of the discriminator corresponding to a signal without multipath.

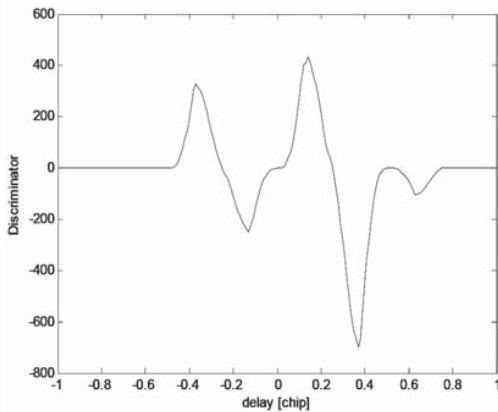


Fig. 4 Discriminator for a BOC(10, 5) signal on a CCRW receiver with  $W_2$

#### IV. CCRW RECEIVER WITH VARIABLE WINDOW WIDTH

The improvement to the previous algorithm consists of incorporating an iterative procedure to find the maximum width of the  $W$  window that will result in the mitigation of the effect of multipath [23]. It is important to remark that the width of the BRW window is kept constant at the value specified in [17], because it does not impact the effect of multipath, it is

only used to eliminate the ambiguity generated by the multiple modulation of the TMBOC and CBOC signals.

Specifically, an initial window width  $\varepsilon$  equivalent to a half chip is iteratively reduced until the distortion on the actual discriminator (generated using the incoming signal) is eliminated. Such distortion is measured as the Euclidean distance between the actual discriminator  $da$  and the local discriminator  $dl$  (generated using a local copy of the signal), i.e.

$$ED = \sqrt{\sum_i \left( da_i(\varepsilon) - dl_i(\varepsilon) \right)^2}; \quad i = 1, \dots, N \quad (12)$$

where  $N$  is the number of samples is smaller than a certain threshold [23]. The algorithm including the improvement is depicted in Fig. 5. On the other hand, the architecture of the receiver is illustrated in Fig. 6.

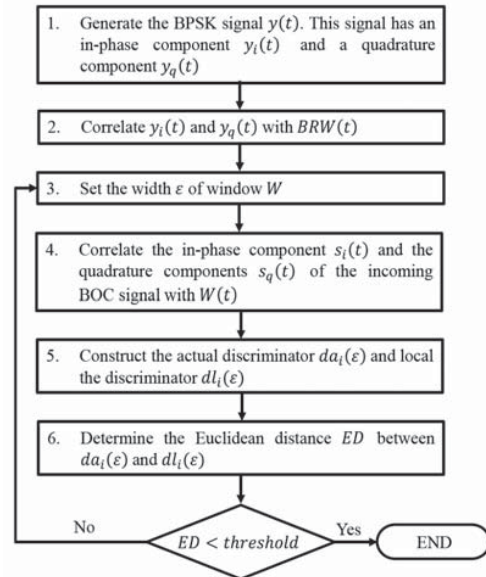


Fig. 5 Proposed algorithm for multipath mitigation using MBOC signals

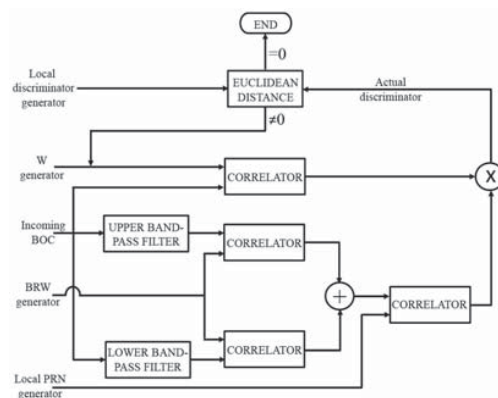


Fig. 6 Architecture of the proposed receiver

## V. RESULTS

As stated before, this work compares the multipath mitigation performance of the CCRW receivers with variable window width [23] and fixed window width [17], [19], [21], for the BOC and MBOC used in GPS y GALILEO that are summarized in Table I [1].

Both types of receivers were implemented in MATLAB, and the performance criterion is the distortion or error in the actual discriminator, measured as the Euclidean distance between the actual discriminator and the local (undistorted) discriminator (generated using a local copy of the signal) as a function of the multipath delay.

First, the multipath mitigation performance on signals  $\text{BOC}(kn, n)$  is evaluated. Then, the performance for multiplexed BOC signals  $\text{CBOC}(6, 1, 1/11)$  and  $\text{TMBOC}(6, 1, 4/33)$  were evaluated.

### A. $\text{BOC}_{\sin}(10, 5)$ , $\text{BOC}_{\cos}(10, 5)$

For these cases, which correspond to  $k = 2$  and  $n = 1$ , Zhe [17] and AlHussein [23] use the  $W_2$  window.  $W_2$  was also used here. Fig. 4 displays the undistorted discriminator for this signal, while Fig. 7 shows the error for both the variable and fixed window width CCRW receivers. Note that the former yields a zero error for all delays, as compared to the latter which exhibits nonzero errors for delays smaller than 0.1 chips, with an error even greater than 1.000 for delays smaller than 0.08 chips.

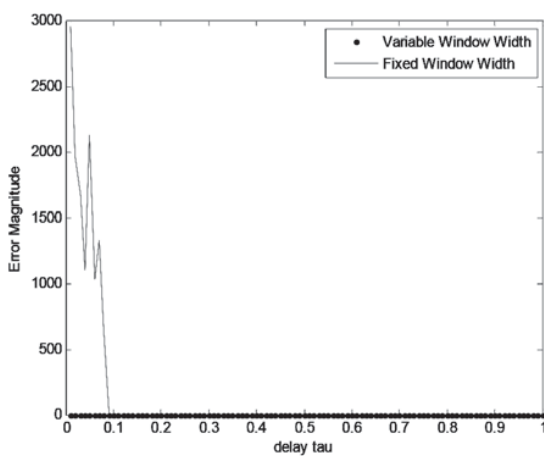


Fig. 7 Error of both receivers for  $\text{BOC}(10, 5)$

### B. $\text{BOC}_{\cos}(15, 2.5)$

This modulation corresponds to  $\text{BOC}(kn, n)$  with  $k = 6$ ,  $n = 1$ . For this signal, a window  $W_2$  with fixed width does not yield a good performance, and Zhe [17] indicates that window  $W_1$  is applicable for multipath mitigation. Therefore, the latter is used here.

Fig. 8 shows the corresponding undistorted discriminator, while Fig. 9 plots the error for both approaches. Similar to the previous case, the variable window width yields zero error for all delays, while the fixed width gives nonzero errors for

delays smaller than 0.1 chips, with errors greater than 100 for delays smaller than 0.09 chips.

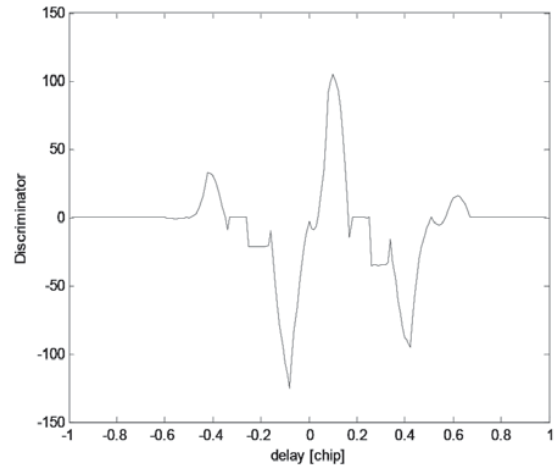


Fig. 8 Discriminator for  $\text{BOC}(15, 2.5)$  with  $W_1$

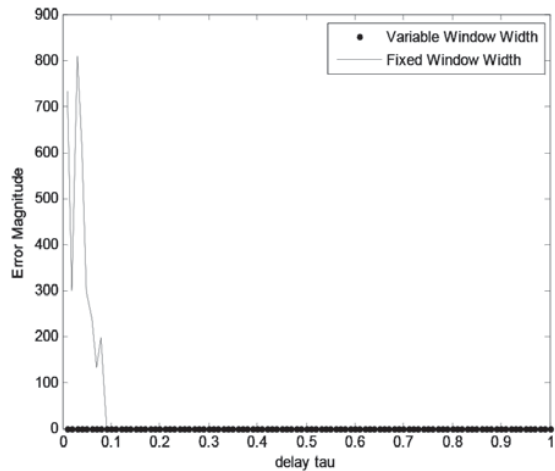


Fig. 9 Error of both receivers for  $\text{BOC}(15, 2.5)$

### C. $\text{CBOC}(6, 1, 1/11)$

This signal was implemented using ((7)). The undistorted discriminator for this case is shown in Fig. 10, while Fig. 11 plots the error for both schemes. Once again, the receiver with variable window width yields zero error for all delays, while the one with fixed window width results in nonzero errors for delays smaller than 0.1 chips and these errors are greater than 2000 for delays below 0.08 chips.

### D. $\text{TMBOC}(6, 1, 4/33)$

In this case, the signal was implemented by means of ((6)). Fig. 12 shows the undistorted discriminators for the  $\text{BOC}(1, 1)$  and  $\text{BOC}(6, 1)$  signals, and Fig. 13 shows the errors of both schemes for the same signals. As before, the variable window width scheme gives zero error for all delays and both signals, while the fixed width scheme yields nonzero errors for delays smaller than 0.08 chips.

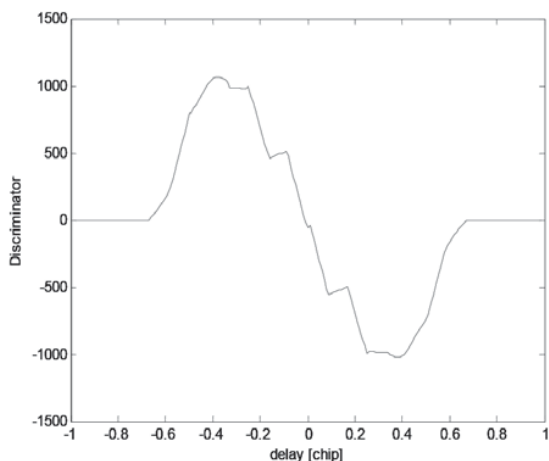
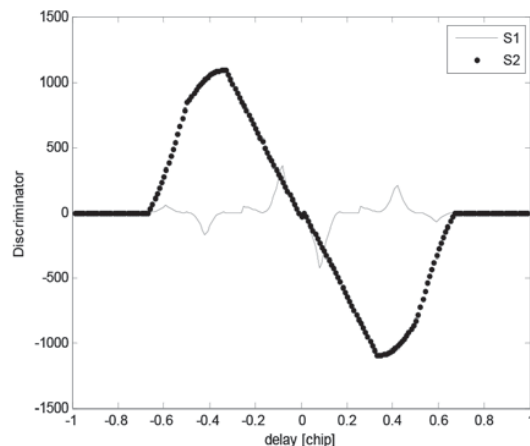
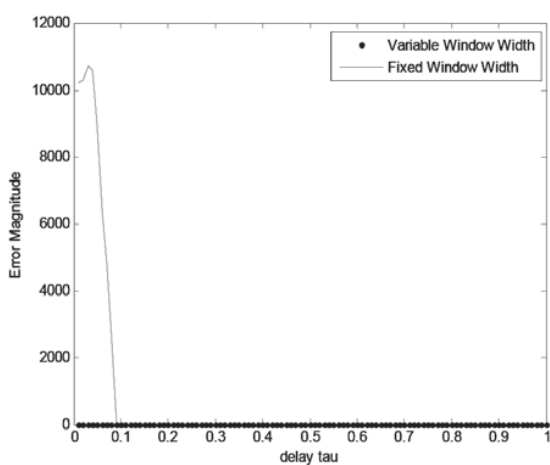
Fig. 10 Discriminator for CBOC(6, 1, 1/11) with  $W_2$  and  $BRW = W_1$ Fig. 12 Discriminators for TmBOC(6, 1, 4/33) with  $W_2$  and  $BRW = W_1$ 

Fig. 11 Error of both receivers for CBOC(6, 1, 1/11)

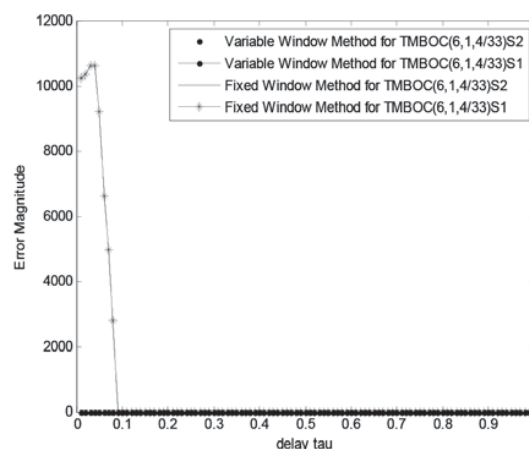


Fig. 13 Errors of both receivers for TmBOC(6, 1, 4/33)

## VI. CONCLUSIONS

This paper compared the multipath mitigation performance of CCRW receivers with variable and fixed window width, for signals  $BOC(kn, n)$ , and multiplexed BOC signals CBOC(6, 1, 1/11) and TmBOC(6, 1, 4/33), which are typically used in GNSS.

The variable window width method incorporates a procedure in which the width of the window is iteratively reduced until the distortion on the discriminator with multipath is eliminated.

Results show that the method with variable window width outperforms the traditional fixed window width method. Specifically, the former yielded zero error for all delays for all signals under consideration, as opposed to the latter which gave rather large nonzero errors for small delays in all cases.

## ACKNOWLEDGMENT

The authors would like to thank King Abdulaziz City for Science and Technology (KACST), and Saudi Arabia Ministry of Education (MOE) for the support they have provided in this work.

## REFERENCES

- [1] J. Avila, "On generalized signal waveforms for satellite navigation," PhD Dissertation, University Faf Munich, Munich, Germany, 2008
- [2] G. Strang and K. Borre, Linear Algebra, Geodesy and GPS. Wellesley, MA: Cambridge Press, 1997.
- [3] J. Betz, Engineering Satellite-Based Navigation and Timing: Global Navigation Satellite Systems, Signals and Receivers. Piscataway, NJ: IEEE Press Wiley, 2016.
- [4] J. Kumar Ray. "Use of Multiple Antennas to Mitigate Carrier Phase Multipath in Reference Stations", Presented at ION GPS-99, Nashville, USA, Sep 14-17, 1999.
- [5] P. Van Torre, I. Lami, M. Al-Aboodi, and A. Alburghaif, "Galileo signals acquisition using enhanced subcarrier elimination conversion and faster processing," in Proc. Int. Conf. . Advances in Computing, Commun. and Inf. Technology (CCIT), Birmingham, England, May, 2015.
- [6] L. Young, "Compatibility of the new military GPS signals with nonaviation receivers," in Proc. 58th Annual Meeting/CIGTF 21st Guidance Test Symp., Albuquerque, NM, 2002, pp. 581-597.
- [7] P. Tamellini, "User graphical interfaces for the study of GNSS and RADAR signals," MS Thesis, Universitat Oberta de Catalunya, Barcelona, Spain, 2011.
- [8] C. Hegarty, "GNSS signals - An overview," in Proc. 2012 IEEE Int Frequency Control Symp., Baltimore, MD, May 2012, pp. 21-24.
- [9] L. Garin, "The 'Shaping Correlator', novel multipath mitigation technique applicable to GALILEO BOC(1,1) modulation waveforms in high volume markets," in Proc. European Navigation Conference (ENCGNSS), Munich, Germany, July 2005, pp. 19-22.

- [10] J. Betz, "Binary offset carrier modulations for radio navigation," *Journal of the Institute of Navigation*, vol. 48, pp. 227–246, Winter 2002.
- [11] J. Betz, et al., "Overview of the GPS M code signal," in *Proc. 2000 National Technical Meeting of The Institute of Navigation*, Anaheim, CA, 2000, pp. 542–549.
- [12] C. Hegarty, M. Tran, and J. Betz, "Multipath performance of the new GNSS signals," in *Proc. 2004 National Technical Meeting of The Institute of Navigation*, San Diego, CA, Jan. 2004, pp. 333–342.
- [13] F. Nunes, "Gating functions for multipath mitigation in GNSS BOC signals," *IEEE Trans. Aerospace and Electronic Systems*, vol. 43, pp. 951–964, July 2007.
- [14] T. Peres, "Multipath mitigation techniques suitable for low Cost GNSS receivers," MS Thesis, *Universidade Tecnica de Lisboa*, Lisboa, Portugal, Sep. 2008.
- [15] F. Sousa, F. Nunes and J. Leitao, "Asymmetrical strobe pulses for multipath mitigation in BOC GNSS receivers," in *Proc. ION 58th Annual Meeting, CIGTF 21st Guidance Test Symp.*, Albuquerque, NM, June 2002, pp. 24–26.
- [16] F. Sousa, F. Nunes and J. Leitao, "Strobe pulse design for multipath mitigation in BOC GNSS receivers" in *Proc. 2006 IEEE/ION Position, Location, And Navigation Symp.*, Coronado, CA, Apr.2006.
- [17] L. Zhe, B. Xu, X. Tang, and F. Wang, "Multipath mitigating technique for BOC(kn,n) signal in GNSS," in *Proc. IEEE Int. Conf. Wireless Commun. & Signal Processing (WCSP)*, Nanjing, China, Oct 2015, pp. 15–17.
- [18] N. Shaojie, J. Pang, K. Zhang, C. Xu, L. Zhe, and F. Wang. "A novel unambiguous W2 CCRW multipath mitigation algorithm applied to BOC (n,n) signals," in *Proc. 2016 China Satellite Navigation Conference (CSNC)*, Vol. II, *Lecture Notes in Electrical Engineering*, pp. 107–113, May 2016.
- [19] L. Zhe, B. Li, X. Tang, and F. Wang, "Unambiguous S-curve shaping for multipath mitigation for MBOC modulated signals in GNSS," in *Proc. 2015 Int Conf. Wireless Commun. & Signal Processing (WCSP)*, Nanjing, China, Oct. 2015.
- [20] J. Wu and A. Dempster, "Unambiguous double delta discriminator for sine-phased BOC(n,n) receiver," *Journal of Global Positioning Systems*, vol. 10, pp. 149–156, July 2011.
- [21] L. Zhe, J. Pang, Y. Liu, and F. Wang, "Double strobe technique for unambiguous tracking of TMBOC modulated signal in GPS," *IEEE Signal Processing Letters*, vol. 22, pp. 2204–2208, Dec. 2015.
- [22] F. Shen, G. Xu, and Q. Li, "Non-coherent unambiguous tracking method for cosine-BOC signals based on an S-Curve shaping technique," *IEEE Signal Processing Letters*, vol. 22, pp. 752–756, June 2015.
- [23] F. Alhussein, H. Liu "An Efficient Method for Multipath Mitigation Applicable to BOC Signals in GNSS" in *Proc. IWCMC-SCN 2019-Satellite Communications and Networking Symposium.*, Tangier, Morocco; June 24–28, 2019.
- [24] T. Ferreira and F. Nunes, "Advanced multipath mitigation techniques for gnss receivers," 2010, (online). Available: [https://www.anacom.pt/streaming/AdvancedTechniques\\_TeresaFerreira.pdf?categoryId=260562&contentId=542680&field=ATTACHED\\_FILE](https://www.anacom.pt/streaming/AdvancedTechniques_TeresaFerreira.pdf?categoryId=260562&contentId=542680&field=ATTACHED_FILE). (Accessed: Oct- 10-2018)
- [25] G. Gera and C. Regazzoni, "Theoretical analysis of S-curve for GNSS system," in *Proc. ION GNSS 2004 Conference*, Long Beach, CA, Sep. 21–24, 2004.
- [26] F. Nunes, F. Sousa and J. Leitao, "An innovations approach to false lock mitigation for GPS/Galileo BOC signals," in *Proc. of the Institute of Navigation GPS/GNSS-2004*, Long Beach, CA, Sep. 2004, pp. 2636–2644.
- [27] J. Wun and A. Dempster, "Tailored spreading symbols in 'strobe correlators' using 'W2-pulses'," *Signal Processing*, vol. 92, pp. 1189–1201, May. 2012.
- [28] A. Burian, E. Lohan, and M. Renfors, "BPSK-like methods for hybrid search acquisition of Galileo signals," in *Proc. 2006 IEEE Int. Conf. Commun.*, Istanbul, Turkey, June 2006.