

The Influence of Pad Thermal Diffusivity over Heat Transfer into the PCBs Structure

Mihai Brânzei, Ioan Plotog, and Ion Pencea

Abstract—The Pads have unique values of thermophysical properties (THP) having important contribution over heat transfer into the PCB structure.

Materials with high thermal diffusivity (TD) rapidly adjust their temperature to that of their surroundings, because the HT is quick in compare to their volumetric heat capacity (VHC).

In the paper is presenting the diffusivity tests (ASTM E1461 flash method) for PCBs with different core materials. In the experiments, the multilayer structure of PCBA was taken into consideration, an equivalent property referring to each of experimental structure be practically measured.

Concerning to entire structure, the THP emphasize the major contribution of substrate in establishing of reflow soldering process (RSP) heat transfer necessities. This conclusion offer practical solution for heat transfer time constant calculation as function of thickness and substrate material diffusivity with an acceptable error estimation.

Keywords—heat transfer time constant, packaging, reflow soldering process, thermal diffusivity.

I. INTRODUCTION

IN the last decade new type of printed wire boards (PWBs) having different core materials as glass, copper or aluminum, completing the classical FR4 or CEM. Addressing only to surface mounted technology (SMT) issues, the new materials are a challenge for conventional assembling technologies, especially regarding heat transfer (HT) into the PCB substrate. As consequence, the pads reaches the liquidus temperature later than the lead, therefore the melted solder alloy is tighten completely by the lead (wicking-up phenomena). The heat conduction in PCB substrate, the speed of heat transfer and heating inertia are influence by the thermal diffusivity (TD). So, in the electronic packaging the necessity of THP measurements not only for intrinsic materials but also for PCB Assembly (PCBA) becomes strongly required, as in [1]. The results of the experiments will be use to improve the high temperature reflow soldering processes based on correlations between functionality and

Mihai Brânzei. is with the Faculty of Materials Science and Engineering, from University POLITEHNICA of Bucharest, 313 Splaiul Independentei, Sector 6, 060042 Bucharest, Romania (phone: 0040-21-4029782; Fax: 0040-21-3169562; e-mail: mihai.brânzei@upb.ro).

Ioan Plotog was with the Faculty of Electronics, Telecommunications and Information Technology from University POLITEHNICA of Bucharest, 313 Splaiul Independentei, Sector 6, 060042 Bucharest, Romania (phone: 0040-21-3169633; Fax: 0040-21-3169634; e-mail: ioan.plotog@cetti.ro).

Ion Pencea was with the Faculty of Materials Science and Engineering, from University POLITEHNICA of Bucharest, 313 Splaiul Independentei, Sector 6, 060042 Bucharest, Romania (phone: 0040-21-4029384; Fax: 0040-21-3169563; e-mail: ini.pencea@gmail.com).

microstructure of solder joints as function of 4P Soldering Model (Pin-Pad-Paste-Process), as in [2].

II. THEORETICAL ASPECTS

Considering the PCBs ensemble (PCBE) composed from substrate, metallic interconnection structures with pads having different finishes and geometry, solder paste deposits, components leads and body, thermal mass (THM) is a concept in electronic packaging which describes how the mass of the ensemble PCBs provides "inertia" against temperature fluctuations determined by the TP in reflow soldering process. THM represent the ability of the ensemble PCBs to store the heat transmitted in the soldering process. Physically thermal mass is equivalent to thermal capacitance or heat capacity (C_{th}):

$$C_{th} = m \times c \text{ [J/K]} \quad (1)$$

where m : PCBs structure mass [kg]; c : Specific heat capacity [J/kg K].

Thermal inertia (TI) is a measure of the THM and the velocity of the thermal wave, which controls the gradient materials temperature. Physically, inertia is equivalent to the thermal effusivity (e):

$$e = (\lambda \times \rho \times c)^{1/2} \text{ [W s}^{1/2} \text{/K m}^2\text{]} \quad (2)$$

where λ : thermal conductivity [W/m·K]; ρ : Density [kg/m³]; ρc : Volumetric heat capacity [J/m³·K]; V : Volume of PCB structure [m³].

VHC describes the ability of PCB in the soldering process to store the heat as internal energy while undergoing a given temperature change according with TP, but without undergoing a phase change. For a given specific heat, value of the material, one can convert it to the VHC multiplying the specific heat by the material density. In the soldering process, a higher value of the VHC means a longer time for the PCB ensemble to achieve temperature according with imposed TP for specific soldering process. The speed of heat diffusion is characterized by the TD (α) of PCB ensemble (PCB substrate, metallic interconnection structures, pads having specific finishes, solder paste deposits, components leads and cases), which govern the heat flow at the PCB surface and from the surface into their interior:

$$\alpha = \lambda(\rho \times c)^{-1} \text{ [m}^2\text{/s]} \quad (3)$$

Therefore, materials with high thermal diffusivity rapidly adjust their temperature to that of their surroundings, because the heat transfer is quickly in compare to their VHC (ρc). In the RSP, the heat transfer must be control in order to realize TP on PCB assemble mass taking into consideration process time constant, as in [2], [3], and [4]. The heat transfer time constant τ can be defined as function of τ_{cv} , specific for the heat transfer by convection to the PCB surface and another, τ_{th} specific for the internal heat transfer by conduction into the PCB structure:

$$\tau_{cv} = \rho \times c \times V / h \times A_{cv} = m \times c / h \times A_{cv} = C_{th} \times R_{cv} \quad (4)$$

$$\tau_{th} = C_{th} \times R_{th} = C_{th} \times x / \lambda \times A_{th} = m \times x / \alpha \times \rho \times c \times A_{th} \quad (5)$$

where A_{cv} : convective heat transfer surface areas, [m²]; A_{th} : PCB conductive heat transfer surface areas, [m²]; x : PCB structure thickness, [m]; h : Heat transfer coefficient, [W/m² K]; $R = 1/h \times A_{cv}$: convective thermal resistance, [K/W]; $R = x/\lambda \times A_{th}$: conductive thermal resistance, [K/W].

Refer to (4) τ_{cv} is proportional with masses ρV and larger C_{th} lead to slower changes in temperature, while larger A_{cv} and better h lead to faster temperature changes. TD has influence in reducing τ_{th} in the heat transfer of RSP (3, 5), which is strongly dependent by assemble PCB thickness.

After substitution, τ_{th} equation goes into:

$$\tau_{th} = x^2 \times \alpha^{-1} \quad (6)$$

III. EXPERIMENTAL CONDITIONS

In order to assure and to define the soldering conditions for PCBs with different core materials, the THP of PCBs, Glass Circuit Boards (GCB), Cotton paper and epoxy (CEM1) and glass-reinforced epoxy (FR4) types, were measured on FlashLine 3000 TD system in conformity with ASTM E1461 standard. The method (Fig. 1) consists in heating one surface of a small disk of the material with a single pulse from a flash energy source, and measuring the resulting temperature rise on the opposite surface as a function of time [5]. The thermal diffusivity value will be calculated using formula:

$$\alpha = 1.388 x^2 / t_{50} \quad (7)$$

where α : thermal diffusivity; t_{50} : the "half max rise time", is the time for the back face temperature to reach 50% of its maximum value, and x is the thickness of the sample.

The specific heat of a material sample can be measured by comparing to a reference sample of known specific heat measured under the same conditions:

$$c_{PCB\ sample} = (m c \Delta T)_{ref} / (m c \Delta T)_{PCB\ sample} \quad (8)$$

Thermal conductivity (TC) values were calculated by (3).

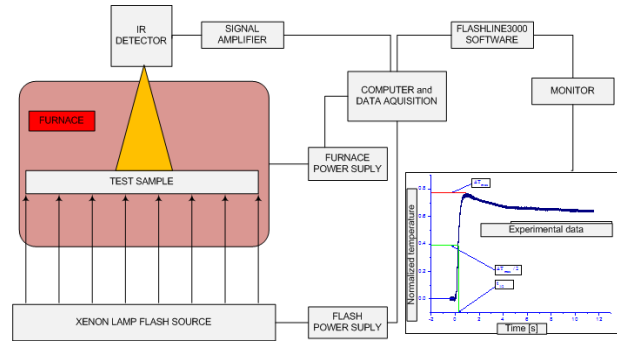

Fig. 1 Schematic of flash diffusivity measurement and temperature rise curve

In the experiments the multilayer structure of PCBs was taking into consideration, an equivalent property referring to each of experimental structure being practically measured.

The samples used (Fig. 2) were made (for each PCB type) from bulk material of substrate, completed with copper foil, traces and assembled with components in order to emphasize the THP differences function of PCB structure.

Sample geometry is a disk with 31.5mm, respectively 12.5mm in diameter. The thickness depends on PCBs type manufacturing stage.

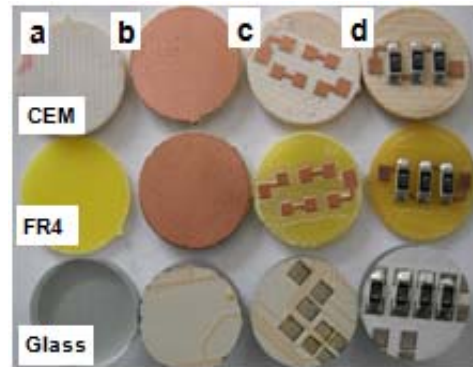
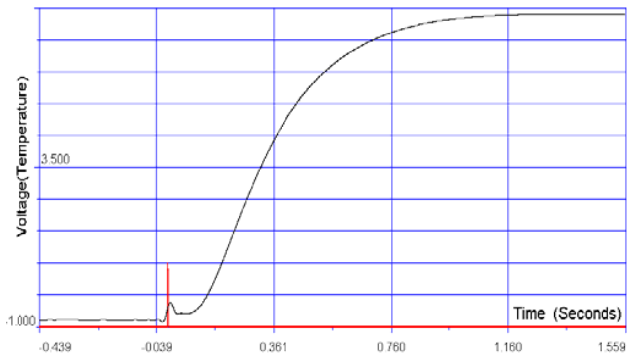

Fig. 2 PCBs measurements probes (a) base material (b) covered with copper foil (c) base material with traces (d) assembled with resistors 1206 type

IV. MEASUREMENTS, RESULTS AND DISCUSSIONS

The measurements results for the FR4 type back face temperatures substrate material samples (Fig. 3) were use for THP calculations (see Table I). Could be notice the contribution of each layer, compared to FR4 substrate the copper traces increase the diffusivity and decrease the conductivity (Fig. 4).

Concerning to entire structure, the THP emphasize the major contribution of substrate in establishing of RSP heat transfer necessities, according with TP requirements (see Table II).



(a)

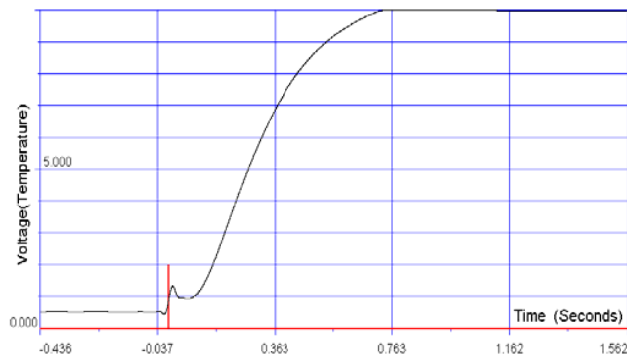

(b)

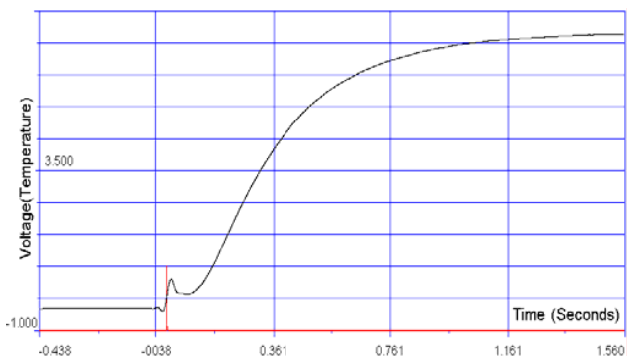

(c)

Fig. 3 Temperature rise curves for FR4 samples (a) FR4 substrate (b) substrate & copper traces (c) substrate, copper trace & components

TABLE I
PCBS FR4 SAMPLES TYPE THP

FR4 sample type	T [°C]	α [cm ² /s]	λ [W/m K]	c [J/Kg K]
FR4 Substrate	106	0.0027	0.47	916
Substrate & Copper Traces	110	0.0030	0.42	746
Substrate, Copper Traces & Components	105	0.0021	0.38	936

The results of PCBs THP measurements emphasize the limits considering probes thickness and forms, material type and thermal profile temperature range, the method asking specific samples geometry.

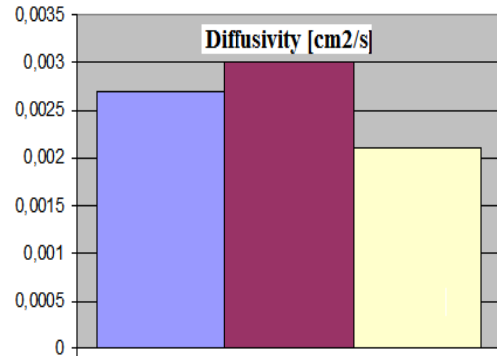

(a)

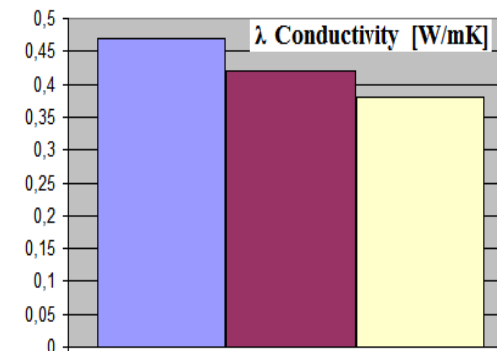

(b)

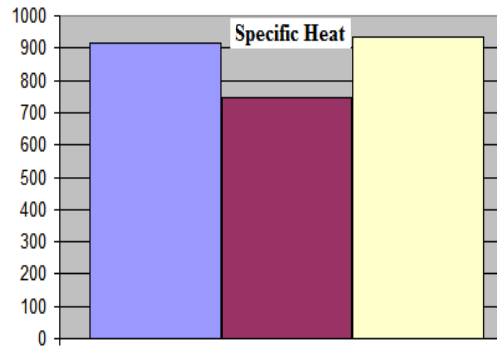

(c)

Fig. 4 Changes of α , λ and c in (a) FR4 substrate (b) substrate & copper traces (c) substrate, copper trace & components

These results offer practical solution for heat transfer time constant calculation as function of thickness and substrate material diffusivity with acceptable error estimation.

According with 4P Soldering Model, the Pad variable P_2 is a function of different finishes types, geometry and substrate core material, each Of the particular solution defined will have unique values for the THP with consequences over TP.

The heat conduction in PCB substrate, the speed of heat transfer and heating inertia are influenced by the THP (conductivity & diffusivity) of 4P Soldering Model key process input variables (KPIV), having as consequence the differences between specific TPs

TABLE II
COMPARATIVE MEASUREMENTS OF THP FOR PCBs WITH FR4, CEM1 AND
GLASS SUBSTRATE

Substrate Type	Thickness, [mm]	Density, [g/cm ³]	T, [°C]	α , [cm ² /s]	λ , [W/m K]	c, [J/Kg K]
FR4	0.71	1.943	106	0.0021	0.387	936
			119	0.0021	0.394	958
			157	0.0019	0.405	1082
			221	0.0015	0.422	1221
CEM1	1.51	1.563	107	0.0011	0.236	1403
			118	0.001	0.231	1425
			157	0.0009	0.219	1494
			220	0.0008	0.175	1612
GLASS	3.94	2.527	108	0.0051	0.658	511
			159	0.0042	0.616	581

V. CONCLUSIONS

TD being a material THP, result the possibility to calculate a thermal time constant specific to standard PWB.

This conclusion offer practical solution for heat transfer time constant calculation as function of thickness and substrate material diffusivity with an acceptable error estimation.

We demonstrated the major influence of the substrate PCB in SMT process by delaying the transmission of heat in the PCB mass caused by its THP.

The delay was express, based on substrate thickness and its thermal diffusivity.

As a practical consequence, it is possible to calculate this delay as a material function, based on TD of the PCB substrate material and its thickness.

Measurement accuracy is sufficient so as to allow the creation of a database concerning delays in the homogenization of the PCB surface temperature, data that can be used for programming the thermal profile for solder process.

The practical problems are generating by the complex geometry of PCBA, being difficult to estimate heat transfer time constant. In consequence, result the necessity of extended THP measurements over the PCB assembly having different substrate materials.

REFERENCES

- [1] M. Brânzei, P. Svasta, F. Miculescu, M. Miculescu, I. Plotog, "Correlation Between the Thermo-physical Properties, Geometry and Microstructure of the SAC305 and SAC-X Typical Solder Joints", in *SIITME 2009, Gyula, Hungary, Conference proceedings CD, ISBN: 978-1-4244-50330309*, pp. 129-133.
- [2] P. Svasta, I. Plotog, T. Cucu, A. Vasile A. Marin, "4 P Soldering Model for Solder Joints Quality Assessment", in *ISSE 2009, Brno, Czech Republic, Abstracts Proceeding ISBN 978-80-214-3874-3*, pp. 56-57.
- [3] I. Plotog, P. Svasta, N. D. Codreanu, T. C. Cucu, C. Turcu, G. Varzaru, G. Lazar, "Investigations on Assembling of Electronic Packages onto Glass Substrates using Lead-free Technology", in *ISSE 2008, Budapest, Hungary, Conference proceedings*, pp. 415-41.
- [4] R. Strauss, *SMT Soldering Handbook, Butterworth-Heinemann Linacre House, Oxford, 1998, ISBN 0 7506 35894*, pp. 179-189.
- [5] <http://thermophysical.tainstruments.com/PDF/technotes/TPN-68%20Thermal%20Diffusivity%20by%20the%20Flash%20Method.pdf>