

The Assessment of Interactions in Ratios Control Schemes for a Binary Distillation Column

R. Bendib, and A. Khelassi

Abstract—In this paper we will consider the most known ratios control schemes ((L/D, V/B),(L/D,V/F), Ryskamp's, and (D/(L+D),V/B)) for binary distillation column and we compare them in the basis of interactions and disturbance propagation. The models for these configurations are deduced using mathematical transformations taking the energy balance structure (LV) as a base model. The dynamic relative magnitude criterion (DRMC) is used to assess the interactions. The results show that the introduction of ratios in controlling the column tends to minimize the degree of interactions between the loops.

Keywords—Distillation, interaction, DRMC, configurations.

I. INTRODUCTION

CONSIDER the distillation column of Fig (1) with a given feed, which has five manipulated inputs, $u = (L \ V \ B \ D \ V_T)^T$. These are all flows, and five controlled outputs $y = (x_D \ x_B \ M_D \ M_B \ p)^T$. These are compositions and inventories: top composition x_D , bottom composition x_B , condenser holdup M_D , reboiler holdup M_B , and pressure p . The process has poles in and or close to the origin and needs to be stabilized. In almost all cases the distillation column is first stabilized by closing three decentralized (SISO) loops for level and pressure, involving the outputs $y_2 = (M_D \ M_B \ p)^T$ the remaining outputs are then the product compositions $y_1 = (x_D \ x_B)^T$ the three SISO loops for controlling y_2 usually interact weakly and may be tuned independently of each other. However, since each level (tank) has an inlet and two outlet flows, there exist many possible choices for u_2 (and thus for u_1). By convention, each choice ("configuration") is named by the inputs u_2 left for composition control.

Manuscript received January 28, 2007.

R. Bendib is with Department of Electrical and Electronic Engineering, University of Boumerdes, 35000 Algeria (phone: (+213) 063 44 56 25, e-mail: bendib_r@yahoo.com).

A. Khelassi is with Department of Applied Automatic, Faculty of Hydrocarbons and Chemistry University of Boumerdes 35000 Algeria (e-mail: a_khelassi@UMBB.dz).

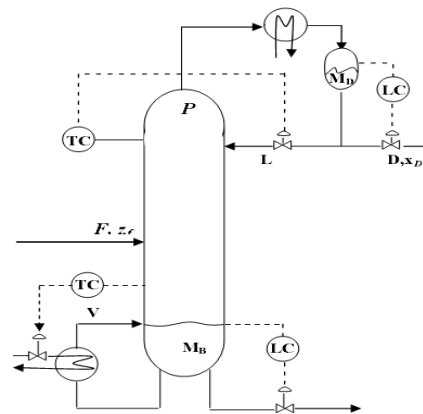

Fig. 1 Distillation column

II. DYNAMIC MODELING OF DISTILLATION COLUMNS

The derivation of analytical expressions requires the assumptions of

- Equilibrium stages.
- Constant relative volatility.
- Constant molar flows.

A. Basic Process Equations ([2],[4])

o Total material balance on stage i

$$dM_i/dt = L_{i+1} - L_i + V_{i-1} - V_i \quad (1)$$

Material balance for light component on each Stage i :

$$\frac{d(M_i x_i)}{dt} = L_{i+1} x_{i+1} + V_{i-1} y_{i-1} - L_i x_i - V_i y_i \quad (2)$$

o Algebraic equations: The vapor composition y_i is related to the liquid composition x_i on the same stage through the algebraic vapor-liquid equilibrium

$$y_i = \frac{\alpha x_i}{1 + (\alpha - 1)x_i} \quad (3)$$

where α is the relative volatility. The above equations apply at all stages except in the top (condenser), feed stage and bottom (reboiler)

o Feed stage, $i = NF$:

We assume that the feed is mixed directly into the liquid at the feed stage

$$\frac{dM_i}{dt} = L_{i+1} - L_i + V_{i-1} - V_i + F \quad (4)$$

$$\frac{d(M_i x_i)}{dt} = L_{i+1} x_{i+1} + V_{i-1} y_{i-1} - L_i x_i - V_i y_i + F x_F \quad (5)$$

o Total condenser $i = NT (M_{NT} = M_D, L_{NT} = L_T)$

$$dM_i / dt = V_{i-1} - L_i - D \quad (6)$$

$$d(M_i x_i) / dt = V_{i-1} y_{i-1} - L_i x_i - D x_i \quad (7)$$

o Reboiler, $i = 1 (M_i = M_B, V_i = V_B = V)$

$$dM_i / dt = L_{i+1} - V_i - B \quad (8)$$

$$d(M_i x_i) / dt = L_{i+1} x_{i+1} - V_i y_i - B x_i \quad (9)$$

III. TRANSFORMATIONS BETWEEN DIFFERENT CONFIGURATIONS

The model for any control configuration can be compactly expressed as:

$$\Delta y = G_{yu} \Delta u + G_{yw} \Delta w \quad (10a)$$

$$\Delta v = G_{vu} \Delta u + G_{vw} \Delta w \quad (10b)$$

where G_{yu} , G_{yw} , G_{vu} and G_{vw} denote the gain matrices. With suitable definitions of, this model could be used to describe any control structure [7]. In general term we refer to this control structure as the "base" structure (in our case LV) and to the variables as follows: y is a vector of primary outputs, u is a vector of primary manipulators and, v is a vector of dependent (or secondary) manipulators, and w is a vector of disturbance variables. Consider now a control structure where ψ is the vector of primary manipulators and v the vector of dependent manipulators (due to inventory control). This control structure can be described by the following model:

$$\Delta y = G_{y\psi} \Delta u + G_{y\omega} \Delta w \quad (11a)$$

$$\Delta v = G_{v\psi} \Delta u + G_{v\omega} \Delta w \quad (11b)$$

In the general case, ψ and v are some functions of u , v , and w that is:

$$\psi = \psi(u, v, w) \quad (12a)$$

$$v = v(u, v, w) \quad (12b)$$

Linearization of equations (12) and introduction of deviation variables give the following relationships:

$$\Delta \psi = H_{\psi u} \Delta u + H_{\psi v} \Delta v + H_{\psi w} \Delta w \quad (13a)$$

$$\Delta v = H_{vu} \Delta u + H_{vv} \Delta v + H_{vw} \Delta w \quad (13b)$$

where H matrices contain partial derivatives of the new variables with respect to the base variables, and because u , v and w are the variables that physically affect the process it must be possible to determine u and v from ψ and measurable disturbances in w . thus means also the relationships:

$$\Delta u = M_{u\psi} \Delta \psi + M_{uv} \Delta v + M_{uw} \Delta w \quad (14a)$$

$$\Delta v = M_{v\psi} \Delta \psi + M_{vv} \Delta v + M_{vw} \Delta w \quad (14b)$$

have to exist. Now the steady state model for the new control structure can be derived as follows: eliminating of Δv from equations (13) by equation (10b) gives:

$$\Delta \psi = (H_{\psi u} + H_{\psi v} G_{vu}) \Delta u + (H_{\psi w} + H_{\psi v} G_{vw}) \Delta w \quad (15a)$$

$$\Delta v = (H_{vu} + H_{vv} G_{vu}) \Delta u + (H_{vw} + H_{vv} G_{vw}) \Delta w \quad (15b)$$

The primary manipulators ψ have to be independent from each other even $\Delta w = 0$, this means that the transformations have to be such that the matrix $(H_{\psi u} + H_{\psi v} G_{vu})$ is non singular, also if the manipulators of the base structure are the variables that in reality affect the column it must be possible to determine u (and v) from ψ , v , and measurable disturbance in w . because v is a dependent variable, u must in principle be determinable from ψ and w . This implies that u can be solved from equation (14a), giving:

$$\Delta u = (H_{\psi u} + H_{\psi v} G_{vu})^{-1} \cdot (\Delta \psi - (H_{\psi w} + H_{\psi v} G_{vw}) \Delta w) \quad (16)$$

Elimination of Δu from equations 10, and by equation (15b) then gives the model in equation (13a) where:

$$G_{y\psi} = G_{yu} (H_{\psi u} + H_{\psi v} G_{vu})^{-1} \quad (17a)$$

$$G_{v\psi} = G_{vu} - G_{vv} (H_{\psi u} + H_{\psi v} G_{vu})^{-1} \quad (17b)$$

$$G_{y\omega} = (H_{yu} + H_{yv} G_{vu}) \cdot (H_{\psi u} + H_{\psi v} G_{vu})^{-1} \quad (17c)$$

$$G_{v\omega} = (H_{vw} + H_{vv} G_{vw}) - G_{vu} (H_{\psi u} + H_{\psi v} G_{vu})^{-1} \quad (17d)$$

Equations 17 provide the relationships between two arbitrary control schemes. And based on these equations we can deduce the model for any control structure knowing the model of the base structure (in our case the base model is the LV model).

IV. DYNAMIC RELATIVE MAGNITUDE CRITERION (DRMC)

The DRMC is a set of plots of magnitude/log frequency for its elements (Khelassi, Bendib [3]). The DRMC elements have been arranged into an array as diagonal and off-diagonal elements and interpreted as graphical representations, the diagonal elements are like the RGA (Gagnepain, Seborg [1]) relate open loop and closed loop behavior of the fully controlled system.

A. The Construction of DRMC Elements

▪ The diagonal elements

$$\delta_{ii}(s) = \frac{\left(\frac{y_i(s)}{u_i(s)} \right)_{\text{all loops are open}}}{\left(\frac{y_i(s)}{u_i(s)} \right)_{\text{all loops are closed except loop } i}} \quad (19)$$

▪ The off-diagonal elements

$$\delta_{ij}(s) = \frac{\left(\frac{y_i(s)}{u_{jsp}(s)} \right)_{i \neq j}}{\left(\frac{y_k(s)}{u_{ksp}(s)} \right)_{k \text{ is constant}}} \quad (20)$$

B. Interpretation of DRMC Elements ([3])

The DRMC clearly expresses how the individual control loops respond to their own set-points through the diagonal elements and to other set points through the off-diagonal elements. From the definition of the criterion, the system interaction caused by the closed control loops, will be very weak for those pairs of variables with a relative magnitude of unity at loops resonant frequencies, as the magnitude of the diagonal elements of the DRMC between controlled variables y_i and manipulated variables u_i departs from unity, more interaction must be expected.

The diagonal elements of the DRMC carry information about how a single loop will respond to changes in its own set point. However they don't supply any useful indication about the direction and magnitude of dynamic interaction with other loops.

The off-diagonal elements δ_{ji} express how much the J^{th} loop is excited relative to the response of the i^{th} loop when a set point is made in the i^{th} loop. The δ_{ji} for the range of frequencies where a system works (i.e. the loop resonant frequencies) should be much smaller than unity for the rejection of true interaction or disturbance between loops.

V. THE ASSESSMENT OF INTERACTIONS IN THE LISTED CONTROL SCHEMES

Figs: (2),(3),(4),(5), and (6) show the DRMC diagonal and off-diagonal elements for LV,(L/D, V/B),(L/D,V/F),

Ryskamp's, and (D/(L+D),V/B) respectively, the resonance frequencies where the DRMC elements are computed are given in Table I. The controllers' parameters (PI controllers) used in order to tune the loops are given in Table II.

TABLE I
THE FREQUENCIES WHERE THE SYSTEM WORKS

Control. Structure	(rad/min) ω_{r1}	(rad/min) ω_{r2}
(LV)	0.01	0.01
(L/D,V/B)	0.01	0.01
(L/D,V/F)	0.01	0.01
Ryskamp's	0.01	0.01
(D/(L+D),V/B)	0.01	0.01

o The PI controllers tuning

TABLE II
THE CONTROLLERS TUNING FOR DIFFERENT CONFIGURATIONS

Control structure	\mathcal{G}_{c1}		\mathcal{G}_{c2}	
	K_p	T_i	K_p	T_i
(LV)	4	41.3	-3	41.3
(L/D,V/B)	79.21	41.3	-65.01	41.3
(L/D,V/F)	43.53	41.33	-20	41.33
Ryskamp's	-1.2	41.33	-166	41.33
(D/(L+D),V/B)	-2.5	41.33	-70	41.33

VI. CONCLUSION

The DRMC elements in the resonant frequencies for the different cases are depicted in Table III.

TABLE III
DRMC VALUES AT RESONANT FREQUENCIES FOR THE ABOVE CASE

Control structure	The diagonal elements		The off diagonal elements	
	δ_{11}	δ_{22}	δ_{12}	δ_{21}
LV	7	7	0.8	1
(L/D,V/B)	3.2	3.2	0.35	0.6
(L/D,V/F)	0.15	0.15	0.016	0.2
Ryskamp's	5.5	5.5	0.6	0.1
(D/(L+D),V/B)	3.28	3.28	0.3	0.5

From the given values we end up with the following results concerning the studied structures.

- *LV Configuration*

As it is shown in Table III the magnitude of the diagonal elements for the range where the system works (i.e. the resonant frequency) are far from unity δ_{11} and $\delta_{22} \approx 7$ which means that strong interactions exist between the loops, the fact that let the (LV) configuration to be not recommended for two points control. For the off-diagonal elements $\delta_{12} = 0.8$ and $\delta_{21} \approx 1$ which indicate that there exist large disturbances between the two loops and propagate approximately by the same magnitude.

- *(L/D V/B) Configuration*

The distillation column under this configuration is interactive as it is indicated by the DRMC diagonal elements $\delta_{11} = \delta_{22} = 3.2$ but compared with the energy balance configuration (LV) the degree of interactions is smaller (this also can be deduced using the RGA). The examination of the off-diagonal elements (shows that $\delta_{21} = 0.6$ is greater than $\delta_{12} = 0.53$ which indicates that there is disturbance propagation from the top loop to the bottom loop. The main disadvantages of this configuration is the need for measurements of all flows L,D,B and V which makes it more failure sensitive and more difficult to implement

- *(L/D V/F) Configuration*

The examination of DRMC values (at the resonant frequencies) shows that which indicates that weak interaction compared with the previous two ratios configuration is expected, for the off-diagonal elements shows that $\delta_{21} = 0.2$ is greater than $\delta_{12} = 0.016$ which indicates that there exist a disturbance propagation from the bottom loop to the top loop, but in this configuration we avoid the disturbances created by the flow rate (because F is included in the primary manipulator). The major drawback for this control scheme is the need of measurements for all flows which makes it more difficult to implement.

- *Ryskamp's Configuration*

The diagonal elements at the resonant frequencies shown in Table III are far from unity, but there values are small compared with those of LV control scheme, which indicates that the degree of interactions exist in this configuration is small compared with conventional control, this is according to decoupling (implicit) effect which results from the property that the scheme holds the reflux ratio constant if the top composition controller is constant. The DRMC off-diagonal elements indicate that there is large disturbance propagation from the top loop to the bottom loop.

- *(D/L+D, V/B) Configuration*

The examination of the diagonal elements shows that there exist interactions between the two loops, but with a magnitude smaller to those of Ryskamp's scheme (this is what Shinsky and Hashimoto have shown [7]), and disturbances propagate

from the bottom loop to the top loop as it is indicated by the off-diagonal elements.

APPENDIX A: NOTATION

- L_i and V_i respectively liquid and vapor flow from stage [Kmole/min]
- x_i and y_i - respectively liquid and vapor composition of light component on stage i [mole fraction].
- M_i liquid holdup on stage i [Kmole].
- D and B distillate (top) and bottoms product flow rate [Kmole/min].
- $L=L_T$ and $V=V_B$ reflux flow and boilup flow [Kmole/min].
- F, z_F feed rate [Kmole/min] and feed composition [Kmole].
- q_F fraction of liquid in feed.
- i . stage n° . (1 =bottom. N_F = feed)
- α Relative volatility between light and heavy component.
- τ_L time constant [min] for liquid flow dynamics on each stage

APPENDIX B: COLUMN USED

Column A: A particular high purity binary distillation column with 40 theoretical stages (39 trays and a reboiler) plus a total condenser [5],[6].

REFERENCES

- [1] Gagnepain.J.P, Seborg.D(1982)"Analysis of process interaction with application to multiloop design" Ind.Eng. Chem. Process Des. Dev. Vol.21.N° 1.
- [2] Halvorsen.I, Skogestad S (2000) "Distillation Theory" Encyclopedia of Separation Science, Academic Press.
- [3] Khelassi. A, Bendib. R (2004) "Assessment of interactions in process control systems". ICDSA 2004, Anatalya, Turkey.
- [4] King (1980) "Separation Process" Mc Graw Hill.
- [5] Skogestad. S (1987) "Analysis and Control of Distillation Columns" CHISA.
- [6] Skogestad. S, (1997)."Dynamics and control of distillation columns" Trans. IChemE, Vol.75.
- [7] Luyben, W (1992) "Practical Distillation Control" Nostrand Reinhold.

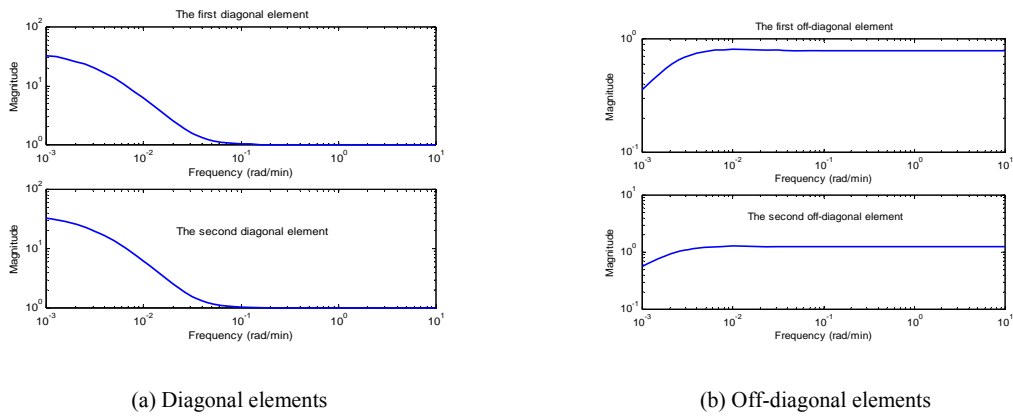

Fig. 2 The DRMC elements (LV) configuration

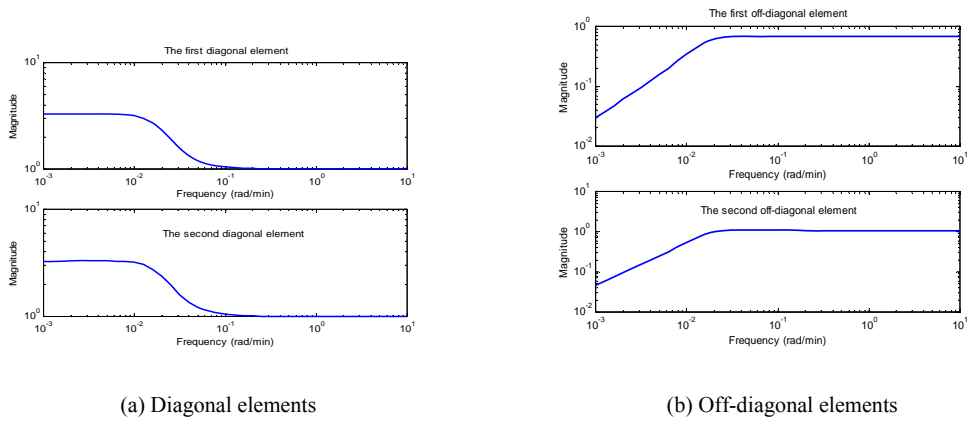

Fig. 3 The DRMC elements (L/D,V/B) configuration

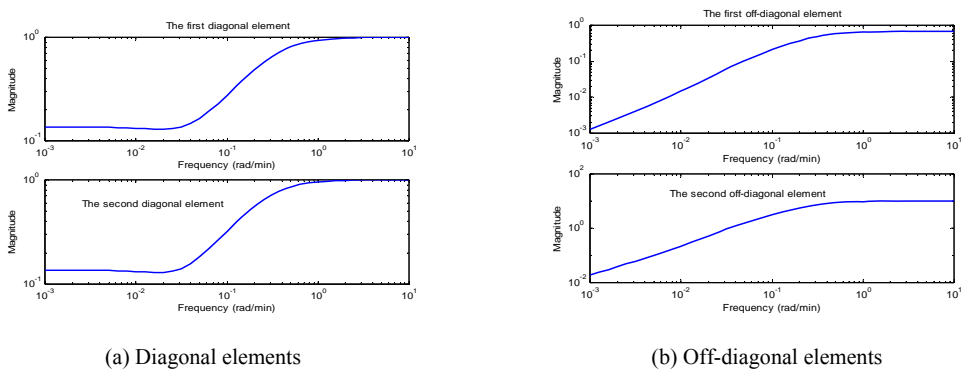
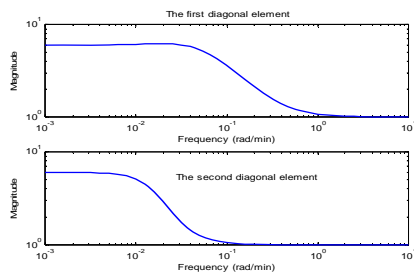
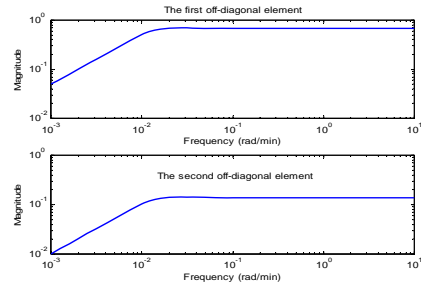

Fig. 4 The DRMC elements (L/D,V/F) configuration



(a) Diagonal elements



(b) Off-diagonal elements

Fig. 5 the DRMC elements Ryskamp's configuration

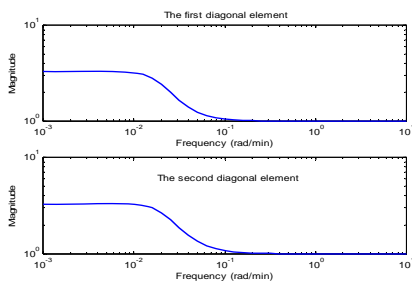

(a) Diagonal elements

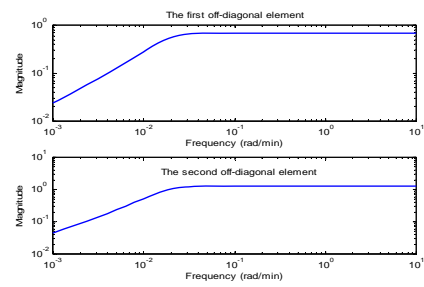

(b) Off-diagonal elements

Fig. 6 the DRMC elements (D/(L+D), V/B) configuration