

# Resonant DC Link in PWM AC Chopper

Apinan Aurasopon

**Abstract**—This paper proposes a resonant dc link in PWM ac chopper. This can solve the spike problems and also reduce the switching loss. The configuration and PWM pattern of the proposed technique are presented. The simulation results are used to confirm the theory.

**Keywords**—PWM ac chopper and Resonant dc link.

## I. INTRODUCTION

IN many applications, such as industrial heating, lighting control, soft start induction motors and speed controllers for fans and pumps requires variable ac voltage from fixed ac source. The phase angle control of regulators has been widely used for these requirements. It offers some advantages such as simplicity and ability of controlling large amount of power economically. However, delayed firing angle causes discontinuity and plentiful harmonics in load current and a lagging power factor occurs at the ac side when the firing angle increased.

These problems can be improved by using PWM ac chopper [1-3]. This PWM ac chopper offers several advantages such as sinusoidal input current with near unity power factor. However, to reduce the filter size and improve the quality of output regulator the switching frequency should be increased. This causes high switching loss. Another problem is the commutation between the transferring switch with freewheeling switch. It cause the current spike if the both switches are turned on at the same time (short circuit), and the voltage spike if the both switches are turned off (no freewheeling path). To avoid these problems, RC snubbers were used [4-5]. However, this increases the power loss in the circuit and is difficult, expensive, bulky and inefficient for high-power applications. The ac chopper with zero current-voltage switching (ZCS-ZVS) was proposed [6]. Its output voltage regulator needs to vary switching-off time controlled by PWM signal. Thus, it is required to use frequency control to achieve the soft switching and the general control systems use the PWM techniques producing switching-on time.

From above reasons, this paper proposes the resonant dc link in PWM ac chopper. This technique has advantages such as simple control with sigma-delta modulation and continues input current. The features of the proposed configuration and PWM patterns are presented and the simulation results are shown to verify the proposed technique.

Apinan Aurasopon is with Faculty of Engineering, Maharakham University, Kantharawichai district, Maha Sarakham 44150, Thailand (phone: +6645-754321, fax: +6645-754316; e-mail: aurasopon@yahoo.com).

## II. DESCRIPTION AND COMMUTATION PROBLEMS IN AC CHOPPER

The power circuit of PWM ac chopper is shown in Fig.1. It consists of the transferring and freewheeling bidirectional switches  $s_1 - s_2$ . The switch  $s_1$  is used to regulate the power delivered to the load, while, the switch  $s_2$  provides the freewheeling path to discharge the stored energy when the output is an inductive load.

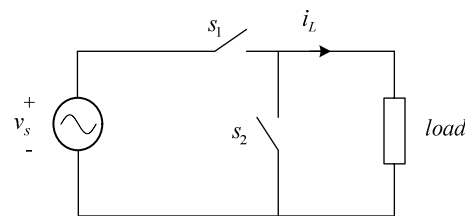

Fig. 1 PWM ac chopper

This PWM ac chopper has the commutation problem. Suppose that a bidirectional switch  $s_1$  is turned on and conducts the load current  $i_L$ . After a time, we wish to commutate the load current  $i_L$  to the switch  $s_2$ . Unfortunately, it is impossible to define the timing which will lead to safe commutation of these switches. Theoretically, the switching must be instantaneous and simultaneous. For practical realization we have to take in account finite switching times and delays in the drive circuits and switches. Therefore, if the switch  $s_2$  is turned on before  $s_1$  is turned off, a short-circuit path is established through  $v_s - s_1 - s_2$ . Current spikes generated in this way will destroy the switches. Similarly, if  $s_1$  is turned off before  $s_2$  is turned on, a dual situation will occur: there is no path for the conduction of the current of the inductive load. Voltage spikes are induced on the opened switches and will destroy the switches.

## III. RESONANT DC LINK IN PWM AC CHOPPER

Figs. 2 - 4 show the principle operation of resonant dc link in PWM ac chopper. In its configuration, the  $L_r C_r$  network is included resonating the line voltage. There are three modes of principle operation:

**Mode I**

In Fig. 2, the switches  $s_1 - s_2$  are turned on by the short pulse to provide initial condition of converter operation. When  $s_1 - s_2$  are opened, the line voltage oscillates and returns to zero generating,  $v_d(t)$ , where upon  $s_1 - s_2$  are turned again. Then, this process can be repeated. The resonant link voltage,  $v_d(t)$ , is given by [7]:

$$v_d(t) = Z(i_{L(0)} - I_0) \sin(\omega_c t) + V_r \cos \omega_r t + (v_{d(0)} - V_r \cos \omega_r t) \cos(\omega_c t) \tag{1}$$

where

- $i_{L(0)}$  initial resonant inductor current;
- $v_{d(0)}$  initial resonant capacitor voltage;
- $I_0$  load current;
- $\omega_c$  angular frequency of resonant circuit =  $2\pi f_c$  ;
- $Z$  resonant impedance =  $\sqrt{L_c / C_c}$
- $V_r$  peak line voltage source;
- $\omega_r$  angular frequency of line voltage source.

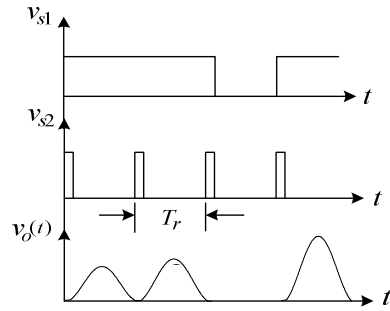
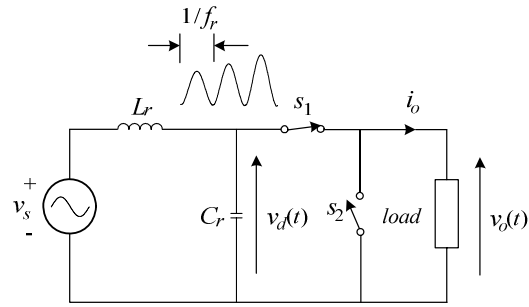

Fig. 3 (a) Circuit for transferring mode and (b) Its waveforms

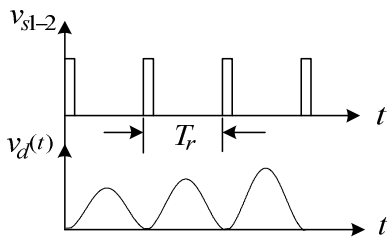
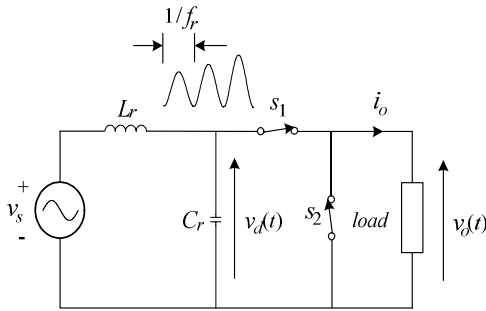

Fig. 2 (a) Circuit for resonant mode and (b) Its waveforms

**Mode II**

In this mode, the switch  $s_1$  is turned on to transfer the energy source to the output load while the switch  $s_2$  is turned off but still turned on by the short pulse. This resulting, the resonant link voltage appears at load terminal and  $i_o$  flows through the output load as shown in Fig. 3.

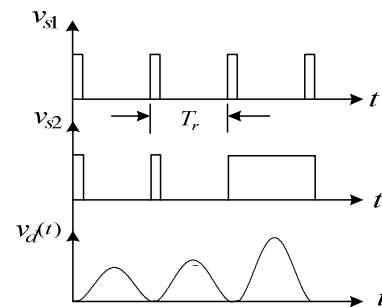
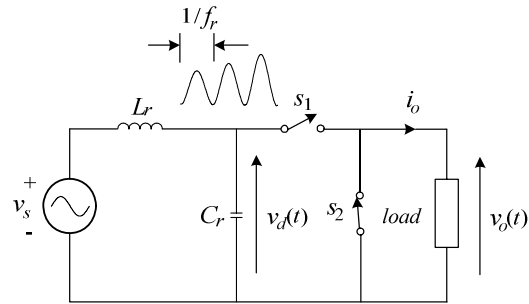

Fig. 4 (a) Circuit for freewheeling mode and (b) Its waveforms

**Mode III**

In this freewheeling mode, the switch  $s_2$  will be turned on to conduct continues load current  $i_o$  for an inductive load while the switch  $s_1$  is still turned on by the short pulse as shown in Fig. 4. From mode I-III, we can conclude that the

resonant dc link technique has no current and voltage spike problems because the both switches will be turned on by the short pulse at the same time to produce the dc link voltage. While, in the conventional PWM ac chopper, after, the transferring mode finished, the freewheeling mode must be immediately started to conduct continues load current. This may cause current spike if the both switches are turned on at the same time and voltage spike if the switch  $s_1$  is turned off before the switch  $s_2$  is turned on.

IV. SWITCHING PATTERNS

To reduce switching losses the switches should be turned on and off at zero crossing of resonant link voltage  $v_d(t)$ . This requirement exists in synchronous sigma-delta modulation (SSDM) as shown in Fig. 5. It consists of summing, integrator and quantizer comparator. The error voltage,  $e$ , is the difference between the input voltage  $v_i$  and the feedback voltage,  $v_s(t)$ . This voltage is fed to an integrator to produce the integrated error signal E. The E then is fed to a quantizer, the output of which depends on the polarity of E. For E positive an output of  $+V_e$  is produced, whereas for negative values of E an output  $-V_e$  is produced. The quantizer output is strobe by sample and hold at a frequency  $f_c$  (the link frequency) to give the output waveforms Q and  $\bar{Q}$ . The duty cycle in case of dc reference signal can be found as:

$$D = \frac{1}{2} \left( 1 + \frac{v_r}{V_s} \right) \tag{2}$$

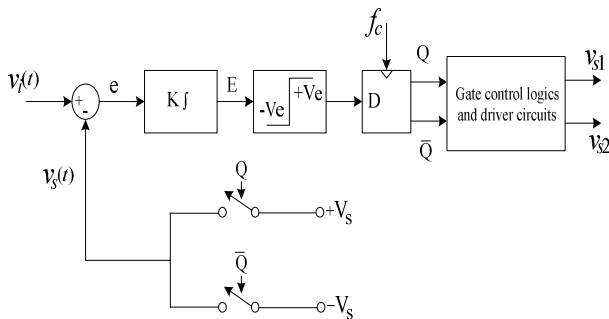

Fig. 5 Block diagram of SSDM

From mode I – III operation, the requirement of gate control logics of  $s_1 - s_2$  is shown as following:

$$\begin{aligned} v_{s1} &= Q + v_{clk} \\ v_{s2} &= \bar{Q} + v_{clk} \end{aligned} \tag{3}$$

where

$v_{clk}$  is clock signal.

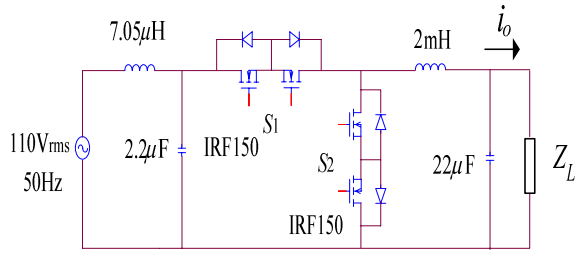
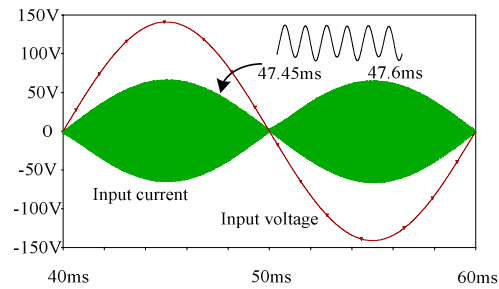
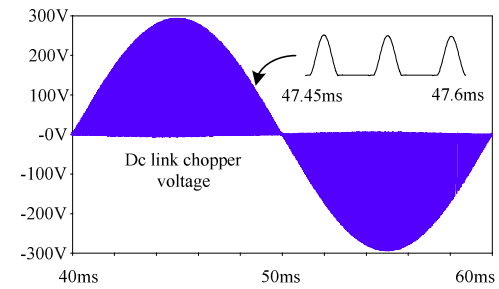

Fig. 6 Circuit diagram of resonant DC link PWM AC chopper



(a)



(b)

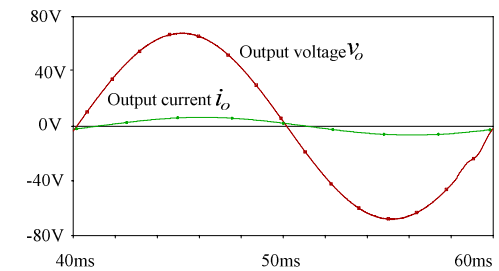

(c)

Fig. 7 Simulation results: (a) Input current and voltage (b) Dc link chopper voltage (c) Output current and voltage

V. SIMULATION RESULTS

To verify the proposed technique, this session shows the simulation results by PSpice program. The system parameters of resonant dc link system are set as following:  $T_{clk} = 25 \mu s$  ( $t_{on} = 5 \mu s$  and  $t_{off} = 20 \mu s$ ),  $L_r = 7.05 \mu H$  and  $C_r = 2.2 \mu F$ . The PWM signal is produced by SSDM having a maximum switching frequency 20 kHz. Fig. 6 shows the resonant dc link PWM ac chopper circuit including low pass filter to filter out

the switching harmonics. Fig. 7 shows the simulation results of voltage and current waveforms at load impedance,  $Z_L = 10 + j3.14\Omega$  and duty cycle,  $D = 0.5$ . Fig. 7 (a) shows the continuous input current and input voltage while Fig.7 (b) shows a waveform of dc link chopper voltage chopped by switching operation. The sinusoidal output current and voltage are illustrated in Fig. 7 (c). Figs. 8 and 9 show the factors of input source. The total harmonic distortion of input current  $THD_i$  is shown in Fig. 8. At low modulation index, the  $THD_i$  is high because of variation of switching frequency of SSDM. Fig. 9 shows the variation of the input power factor (PF) versus the duty cycle. It is measured by using Equation (4).

$$PF = \frac{I_{L_f}}{I_L} \cos \theta \tag{4}$$

where

$I_{L_f}$  is the fundamental component of input current,

$I_L$  is the input current harmonics,

$\theta$  is the phase angle between fundamental component of input current and voltage.

It shows a poor power factor due to the presence of input current distortion. This result is the same as hard switching PWM ac chopper. But it remains still better than that obtained by delayed firing angle control technique.

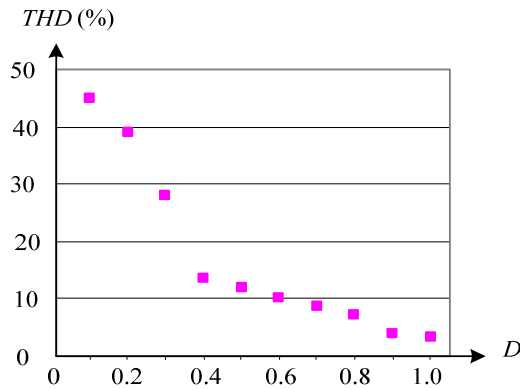

Fig. 8 Total harmonic distortion of input current

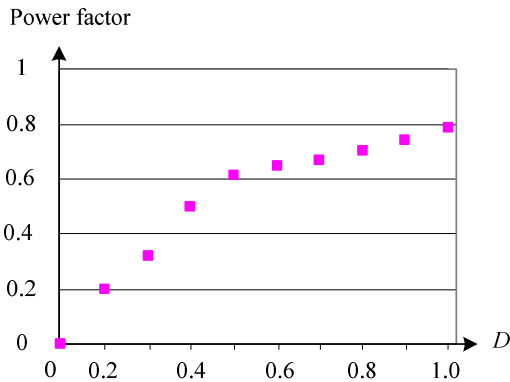

Fig. 9 Variation of input power factor versus duty cycle

The total harmonic distortion of the output voltage  $THD_v$  is shown in Fig. 10 measuring at load impedance,  $Z_L = 10 + j3.14\Omega$ . It shows that at modulation index,  $D = 0.5$ , the  $THD_v$  is minimum because the ac chopper operates at the maximum switching frequency 20 kHz. At low modulation index, the  $THD_v$  is high. However, if the  $THD_v$  is concerned in some applications. It can be reduced by increasing switching frequency that does not affect the efficiency of ac chopper. Fig. 11 shows the loss variation of the resonant dc link in ac chopper circuit measuring at resistive load. This result shows that its efficiency characteristic is high.

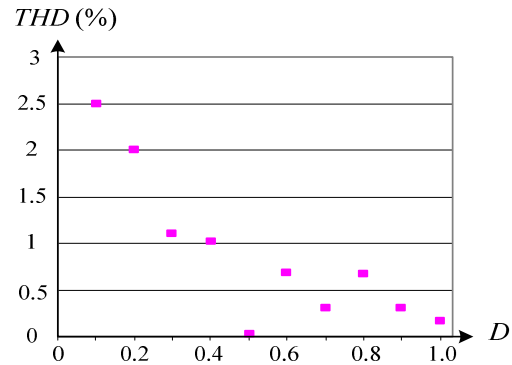

Fig. 10 Total harmonic distortion of output voltage

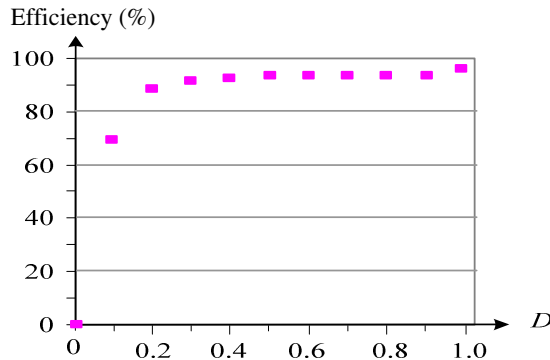

Fig. 11 Efficiency variation versus duty cycle

### V. CONCLUSION

This paper has presented the resonant dc link in PWM ac chopper. The configuration of the proposed technique is simple and easy to control. The resonant dc link in PWM ac chopper has advantages such as high efficiency, and no current and voltage spikes because in the mode operation the switches are turned on and off at zero voltage. These are confirmed by simulation results.

REFERENCES

- [1] D. H. Jang, J. S. Won, and G. H. Choe, "Asymmetrical PWM method of ac chopper with improved input power factor," IEEE PESC'91, pp. 838-845, 1991.
- [2] S. Srinivasan and G. Venlataramanan, "Comparative evaluation of PWM AC-AC converters," IEEE-PESC'95 Conf. Rec., pp. 529-535, 1995.
- [3] Nabil A. Ahmed, Kenji Amei, and Masaaki Sakui,, "A New Configuration of Single-Phase Symmetrical PWM AC Chopper Voltage Controller," IEEE Trans. Indus. Elec., vol. 46, No. 5, pp. 942-952, October 1999.
- [4] Salazar, I, Vasquez, C., and Weichmann, E, "On the characteristics of a PWM ac controller using four switches," IEEE-PESC Conf. Rec., pp. 307-313, 1991.
- [5] Joos. G., and Ziogas, P.D, "A PWM ac controller-based high current power supply," in IEEE-IECON'91 Conf. Rec., pp. 554-559, 1991.
- [6] Jung G. Cho and Gyu H. Cho, "Single-Cycle Resonant Converters: A New Grop of Quasi-Resonant Converters Suitable for High-Performance dc/dc and ac/ac Conversion Application," IEEE Trans. Indus. Elec., vol. 38, No. 4, pp. 260 – 267, August 1991.
- [7] D.M. Divan, "The resonant dc link converter-a new concept in static power conversion," IEEE Trans. Ind. Appl., vol. IA-25, pp. 317 – 325, Mar./Apr. 1989.