

Recycling-Oriented Product Assessment during Design Process with Usage of Agent Technology

Ewa Dostatni, Jacek Diakun, Damian Grajewski, Radosław Wichniarek, and Anna Karwasz

Abstract—In the paper the method of product analysis from recycling point of view has been described. The analysis bases on set of measures that assess a product from the point of view of final stages of its lifecycle. It was assumed that such analysis will be performed at the design phase – in order to conduct such analysis the computer system that aids the designer during the design process has been developed. The structure of the computer tool, based on agent technology, and example results has been also included in the paper.

Keywords—Agent technology, PLM, design for environment, ecodesign.

I. INTRODUCTION

AN innovative approach to design and manufacturing of the modern products is closely related with a holistic approach to all stages of the product life cycle. One of the tendencies in modern design of the products is taking into account the aspects that have been not important before. Among them are the widely understood environmental issues. Environmental requirements imposed on manufacturers, associated both with the legal and economic requirements, forcing reorientation of companies' business processes on issues related to recycling, disposal and recovery of materials or components.

This approach also has its impact on the IT systems used by the various professionals (actors) involved at the different stages of the product life cycle (designers, engineers, production managers, etc.). Current trends and needs are for process integration by sharing data generated at different stages of the product life cycle with interfaces built into individual applications (e.g. PLM systems).

Intensified production quickly depletes natural resources and energy and increases a quantity of post-manufacturing and post-use waste. Consequently, designers are challenged with

new tasks of designing environment-friendly products. Manufacturers of electrical and electronic equipment, according to the WEEE directive [1], are especially obligated to reclaim or recycle a specified quantity of produced goods. Recycling possibilities for a product are determined during the design phase, through selection of proper materials and types of joints between parts. Therefore, for running an assessment of environmental parameters of a designed product, computer tools aiding this evaluation are becoming necessary. Presently, systems that aid designers in the decision-making process during pro-ecological design are still in the developmental stage.

On the other hand it is known that the most significant effects of the implementation of modern techniques can be conducted in the early stages of product development, i.e. in design phase. Therefore, the introduction of environmental aspects into early stage of the design process is very important. Those kinds of activities are called ecodesign.

Ecodesign is a new approach to the design of products. It is based on the identification of environmental aspects of the product and turning them into the design process at the very first stages of development. This approach is also referred to an environmental design and design according to the principles of sustainable development. In the literature are the following terms: ecodesign, DfE (Design for Environment), environmental design, ecological design, sustainable product design, green design. Ecodesign introduces an additional dimension to the traditional design and can be done in a twofold manner. First, the design involving the creation of eco-innovative products, that is, the aim of which is to design a product that meets the criteria for eco-innovation. In practice, this means that a device designed not only to satisfy ecological standards, but it will be made of materials which allow the complete recycling or biodegradable. Also, the manufacturing process will meet the highest standards and make a pro-environmental production. The second approach involves the introduction of ecodesign aspects of a traditional product design in order to improve environmental performance, but without a fundamental change in the concept of the product. Ecodesign is also the basis for the design of such a product, which will consist of recyclable materials, compatible materials, renewable materials and is easy to remove. An important element is the label of the product to facilitate subsequent recycling. Figure 1 shows the aspects of ecodesign taking into account recycling issue. The ideal solution would be to design the product, all of which could be

E. Dostatni is with the Faculty of Machine Engineering and Management, Poznań University of Technology, Poland (phone: 48 61 665 2731; fax: 48 61 665 2774; e-mail: ewa.dostatni@put.poznan.pl).

J. Diakun, was Faculty of Machine Engineering and Management, Poznań University of Technology, Poland. He is now as IT specialists with PR company (e-mail: jacek.diakun@put.poznan.pl).

D. Grajewski is with the Faculty of Machine Engineering and Management, Poznań University of Technology, Poland (phone: 48 61 665 2718; fax: 48 61 665 2774; e-mail: damian.grajewski@put.poznan.pl).

R. Wichniarek is with the Faculty of Machine Engineering and Management, Poznań University of Technology, Poland (phone: 48 61 665 2738; fax: 48 61 665 2774; e-mail: radoslaw.wichniarek@put.poznan.pl).

A. Karwasz is with the Faculty of Machine Engineering and Management, Poznań University of Technology, Poland (phone: 48 61 665 2718; fax: 48 61 665 2774; e-mail: anna.karwasz@put.poznan.pl).

recycled. Such a solution is not possible because it must meet other criteria such as have adequate functionality and have a competitive price. Often, all the requirements are different.

II. RECYCLING ASSESSMENT

Particularly unfavorable situation occurs when in the product construction there are permanent connections of elements that are incompatible materials, i.e. materials which can not be recycled together.

Another factor contributing to the recycling properties of the product are the connections used in its structure. Specific solutions in terms of connections used in the construction may affect the evaluation of this kind in a positive or negative. For example, the use of permanent joints will complicate the disassembly process (and thus recycling) of the product. That is why it might be preferable in this case to replace the permanent connection by the separable connection. In turn, the use of different types of separable connections (e.g. bolts of different sizes, with different notches screw head, etc.) will also adversely affect the disassembly process because it requires the use of different tools.

As part of the overall problem undertaken by the authors assumed that the assessment of the product will be done automatically. The process of product design will be evaluated by the algorithms during or after the construction work in designer's environment, i.e. 3D modeling environment. Given the nature of the model evaluation measurement taken, the elements listed above, as relevant to the evaluation device, input suitable algorithms. This implies the need to solve the problem of obtaining such data from the 3D model of the product.

We present a detailed solution for the representation of connections used in the model. This solution builds on an original concept modeling calls, originally implemented in the form of a system based on a relational database, which also serves as the continuation of the work done in the field of ecodesign in the wider parent body co-authors of this article.

As mentioned above it is very important that the product's needs for its recycling are included at the early stages of design process. Therefore, the ecodesign support tools should be integrated with other IT tools supporting design work. The solution which will be briefly described in the paper consists of several plug-ins for CAD 3D software created by the authors and software that works with CAD system based on agent technology.

In order to develop tools based on agent technology integrated with the CAD system for product's recycling assessment, special measures have been developed for determining susceptibility to the recycling of household appliances. Measures were built on the basis of factors and prepared in accordance with the directives and laws.

For the evaluation of the product for recycling purposes the authors propose the following assessment measures to be considered:

1. number of different materials (WM),
2. number of toxic materials (WT),
3. number of various connections (WP),
4. recycling level (P_R),
5. recycling index (WR),
6. recycling cost.

The number of different materials. The less the number of different sort of materials, the easier the recycling. If materials in the products are the same, then there is no need to disassemble it because materials can be recycled together. The situation similar to the above is when materials are compatible, in other words, the materials can be recycled without the need to separate them.

Weigh coefficient of a variety of used materials takes weigh values, defined on the basis of percentage number of different materials used to manufacture specific parts, with relation to all materials used. For example, if a product contains 25 materials, while six materials are different, then the percentage index of a number of different materials is 24%, in other words, the weigh index is 1.5.

The number of toxic materials. The number of toxic materials is one of the most important aspects of assessment in environmental design. The designers, in keeping with the idea and good practice of design, should proceed with designing in such a way that there may be as few toxic materials in the product as possible. In the ideal solution the ready-made product does not contain any toxic substances or materials. Nevertheless, there are examples of products (at refrigerator, where Freon is a dangerous substance) where such a solution is impossible to implement because of the loss of properties. Then, a designer must design the products in such a way that toxic material may be possible to remove in the products recycling phase. This coefficient takes a value reflecting at the real number of toxic materials presents in the product.

The number of various connections. The fewer number of different types of connections, the easier and faster it is to recycle products and this, in turn, reduces the costs of recycling. Less variety of connections in the product makes it easier to disassemble it, because there is no need to change tools very often. If disassembly is automated, the disassembly line does not need to be adjusted to a large number of different types of connections.

The best solution based on that sort, while all connections in the products are disjoint. Then, disassembly of the product is straightforward and uncomplicated. In case of the connections being impossible to detach the disassembly is usually not performed due to high costs. If connected materials are incompatible, the product does not qualify for recycling. For example in case of or glued connections, the paste between materials lowers the value of the material useful for recycling. Then, substances which amend the process are necessary because they improve the properties of the products of recycling.

Weigh coefficient of variety of connection types, similarly to the weigh coefficient of variety of materials used to manufacture the products takes weigh values. This result is a

basis for calculating recycling index.

Recycling level. Recycling level is an important indicator in product assessment from the recycling viewpoint. Electrical and electronic equipment manufacturers are obliged to reach a minimal recycling level [2]. Principles of calculation of recycling level are spelt out in the appropriate regulation [3].

The formula for recycling level is as following:

$$P_R = \frac{M_R + M_U}{M_Z} \cdot 100\%,$$

where:

P_R – recycling level [%];

M_R – is the weight of a waste generated by reprocessing of used equipment, regarding equipment from a given group, which has undergone a process of recycling [kg],

M_U – is the weight handed back for a re-usage or parts originating from used equipment from a given equipment group [kg],

M_Z – is the weight of used equipment, collected and transferred to a recycling facility registered in the files mentioned in article 6 f the Act of 29th of July 2005 on used electrical and electronic equipment [kg].

Recycling index. Recycling index depends on coefficients mentioned above. It is constituted of elements indicating the following: number of different materials, number of different types of connections, recycling level.

The recycling index is a sum of coefficients defining numbers of different materials, different types of connections and recycling level. The lower the sum of the better is the design of the project from recycling viewpoint.

$$WR = WP + WM + WPR$$

where:

WP – Weigh coefficient of variety of connections used,

WM – Weigh coefficient of variety of materials used,

WPR – Weigh coefficient of recycling level.

Recycling cost. In accordance with the requirements of the standards and guidelines the costs of recycling and disassembly were also taken into account. The cost of recycling, referred to in this paper as total cost of recycling, according to the following formula:

$$\text{Total cost of recycling} = \text{recycling cost} - \text{disassembly cost}$$

is one of the elements necessary to assess a product from the recycling viewpoint. The cost of recycling is important from the standpoint of manufacturers and processing companies. In order to be able to calculate the total cost of recycling one needs to define the cost of disassembly and the cost of recycling of the materials.

The cost of manual disassembly depends on the company carrying out the process way that disassembly is carried out. In time of disassembly is the key element influencing its cost. The cost depends on the hourly rate of the company's employee. The type of tool used also influences the cost of disassembly. If it is an electrical hand tool another cost

component should be taken into account namely the cost of electricity.

The cost of mechanical or automatic disassembly depends on the company and the kind of line used. The main parts of mechanical disassembly cost are: the cost of remuneration of the employee, cost of amortization of machines, and the cost of electrical energy used.

The cost of material recycling is another indispensable element needed to calculate the total cost of recycling. The most important criterion of calculation of recycling costs in a material is its weigh, but also its purchase price, or sale price. The purchase/sale price depends on the type of recycled material, because recycling of some materials is costly, while for some, money is offered when delivered for recycling to special collection points.

The cost of recycling of materials present in the product is the difference between profit from selling those materials and other costs which had been borne. Profit is made on sales of materials useful for recycling, while costs is generated when such materials are stored and utilized. Negative result of recycling past signifies their loss, while positive result signifies profit.

The total cost of recycling is a difference between recycling cost and disassembly cost. Positive result means profit, while negative result means loss - in other words their company will have to pay up for recycling, utilization, and storage.

The above-mentioned indicators and recycling rates have been implemented in a system that supports eco design of products focused on recycling. These indicators are in fact measures by which evaluation of the product in terms of its susceptibility to recycling is possible. Developed and rate coefficients allow designer to check the extent to which the designed product meets the requirements of the directives, laws and standards for ecodesign.

III. EXTENDED PRODUCT MODELING FOR RECYCLING PURPOSES

It was assumed that the assessment measures described above will be calculated automatically based on the product model. In order to fulfill this assumption it was necessary to extend typical product model by adding additional data that describe product more precisely from recycling point of view. These additional data encompass two main elements:

- model of connections,
- extended material data.

Because of the influence of connections' types being used in the product design on its recycling assessment, that aspect is also included (and emphasized) in the presented solution. During the design, the designer defines every connection used in the product, describing what parts are connected by another. These data are then used by algorithms that analyses such structure and automatically calculates assessment measures.

Recycling purpose requires more detailed description of the materials used in the product. It was reflected by extended

material data – the additional information on material includes i.e. its hazardous and graphic sign. Another important aspect is so-called compatibility between types of materials. That property describes when two materials can be recycled together. This information is also defined in the presented solutions.

The concepts described above have been implemented in two computer tools. The first one, a computer tool supporting a designer during the design process, based on the all the data stored in the database, has been developed. Then, based on this experience, this concept was moved into “natural” nowadays design environment – a CAD 3D modeling system. In both cases the calculations of the recycling assessment measures is conducted by agent system.

IV. RECYCLING ASSESSMENT TOOL BASED ON AGENT SYSTEM AND PRODUCT MODEL STORED IN THE DATABASE

Recycling indices and coefficients mentioned above have been implemented in environmental design aiding system focused on recycling, and constitute measures according to which one may assess a product from the viewpoint of its recycling capability. Coefficients and indices developed to assist the designer, helping him/her to check to what extent a designed product meets requirements included in directives, acts, and ecological design standards. In particular, in relation to the following regulations, the products: (I) should not contain materials containing toxic elements, as defined in the RoHS directive [4], (II) products should consist of as few materials as possible, because it will facilitate recycling, (III) products should have as few different connections and joins as possible, and as many disjoint connections as possible, because it will facilitate disassembly, (IV) products should reach recycling level defined in the [2], (V) products should be clearly and visibly marked, because it will facilitate selection of materials fit for recycling, (VI) after such materials have been recycled, they should generate profit.

The requirements described above, together with assessment measures, have been implemented in computer tool that supports the analysis. The system bases on agent technology and the following agents has been implemented:

- “Designer” (interface agent), that communicates with the user,
- “Corrector” (task agent), that analyzes product from the its correctness point of view,
- “PRManager”, that calculates measures of assessment,
- “Advisor”, that indicates the important (from recycling point of view) product elements,
- “Matchmaker”, that is responsible for communication between agents,
- “InfoAgent”, that communicates with database.

The main modeling tool is the designer interface, where the product structure with additional data is defined. The structure of the system is presented on Fig. 1.

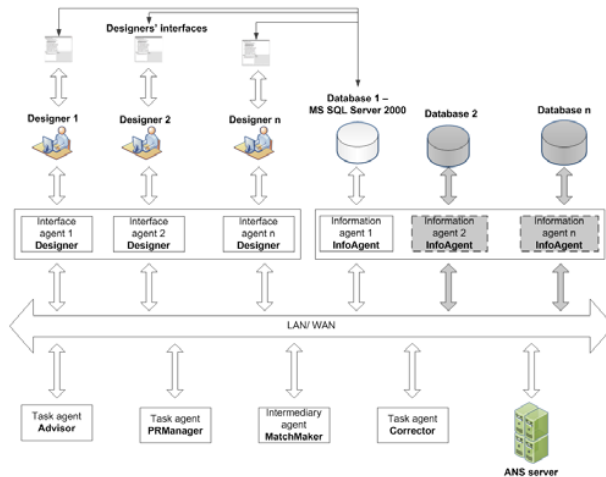

Fig. 1 Agent System structure

The design process consists in creating and modifying its structure. The base product structure has typical form – a product tree. Its creation is conducted by designer’s interface (Fig. 2).

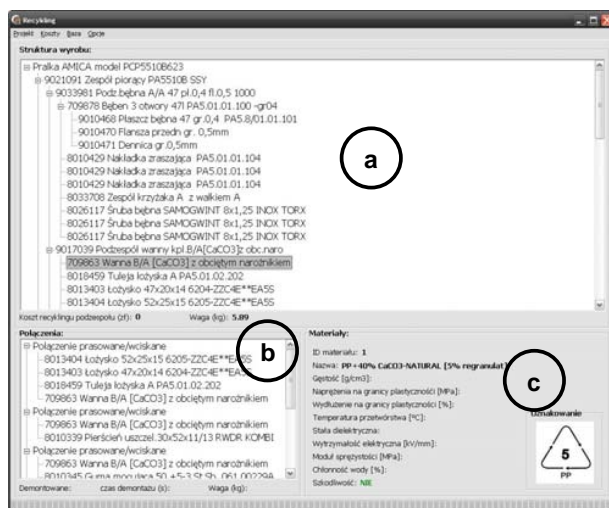

Fig. 2 Main windows of the designer’s interface: (a) product structure, (b) current part’s connections structure, (c) material information with graphic sign

The design process of the product is reflected by adding parts and components into product tree. These elements (parts and components) are previously defined in library implemented in the system (Fig. 3). The product structure is then completed with data on connections between parts and components (Fig. 2(b)).

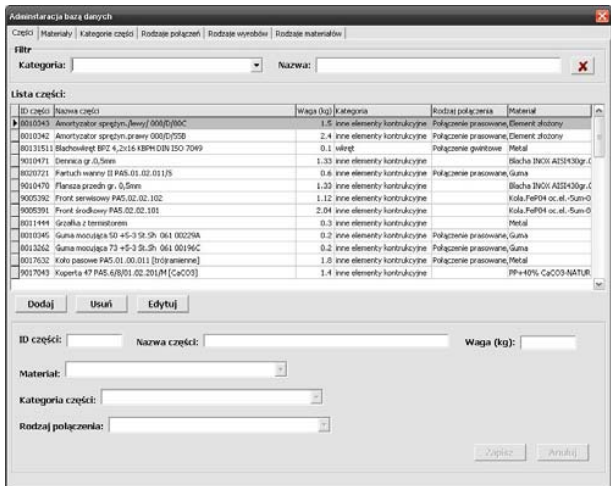

Fig. 3 Parts library defined in the system

The example of analysis according to the proposed approach will be presented based on the electric kettle (Fig. 4), manufactured by Polish household company Zelmer [5]. The structure of the real product has been analyzed and entered into assessment tool. The result of the analysis is shown on Fig. 5.

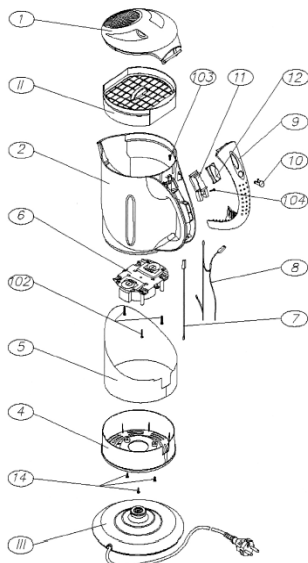

Fig. 4 View of the example product (electric kettle) being analyzed from recycling point of view

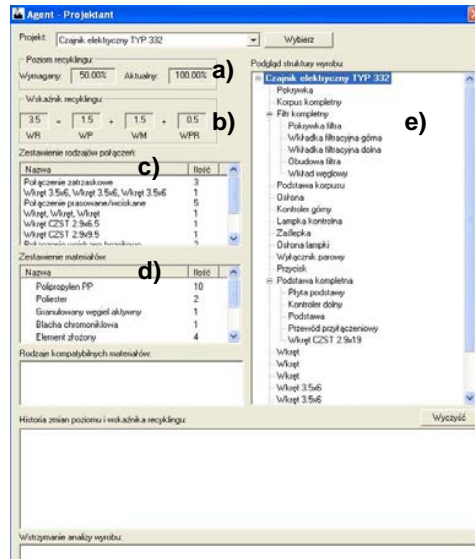

Fig. 5 Analysis results of the example product (electric kettle) being analyzed according to the proposed measures: (a) recycling level, (b) recycling index (WR) and its component coefficients (WP, WM and WPR), (c) connections summary, (d) materials summary, (e) product structure view

The main disadvantage of the solution described above is connected with its independency from CAD modeling. That way the designer has to enter product structure two times: one in CAD and then in recycling assessment tool. In order to eliminate this disadvantage, this concept has been moved and implemented into 3D CAD modeling system. Because at the time of preparing of this paper only the modeling part has been developed, this aspect will be described (the analysis part, based also on agent system, is being developed at the time of preparation of this paper).

V. RECYCLING ASSESSMENT TOOL BASED ON EXTENDED PRODUCT MODEL STORED IN CAD 3D MODELING SYSTEM

In order to eliminate the “double” modeling, what was the main disadvantage of the solution described above, the concept of extended product model for recycling purposes was moved and implemented into CAD 3D modeling system – that way the designer is able to conduct the analysis in one environment.

Except for the standard modeling activities in 3D modeling system, the designer assigns types to every part and component of the model (Fig. 6).

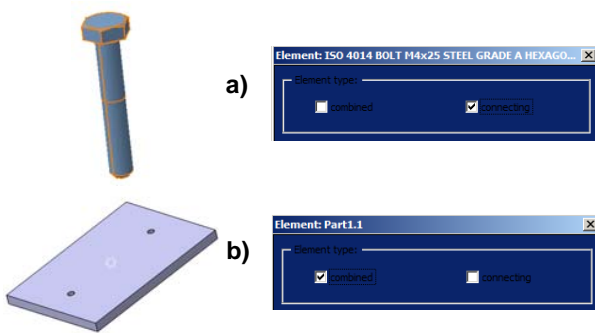

Fig. 6 Connection type modeling examples: (a) screw as connecting part, (b) plate as combined part

Another step of modeling is connection defining. Except for defining standard geometrical constraints in the model, the designer defines all the connections in the model from the point of view of recycling (Fig. 7).

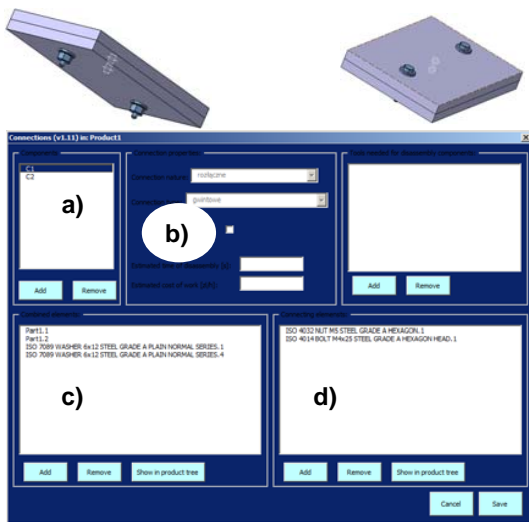

Fig. 7 Connection modeling example: a view of a component (two plates connected with two screws, two nuts and four washers) and its connection model: (a) list of connection between parts (plates), (b) connection attributes, (c) list of combined elements, (d) list of connecting elements

The extended product model has been implemented in Catia 3D modeling system.

VI. CONCLUSION

The concept and its computer implementation presented in this paper, may be considered from two standpoints: the method of assessment of the product from recycling point of view and product modeling, including the data necessary to conduct the analysis automatically from the product model. That way a different approach to PLM emerges: with product model as the base, that includes not only data necessary at current step of the design (and product lifecycle), but also data

that will be needed in further stages of product lifecycle. In the opinion of the authors, this concept (or its elements) could be implemented in exact or similar way by PLM vendors in their software.

ACKNOWLEDGMENT

This work has been financially supported by the Polish Ministry of Science and Higher Education, research project no. 2423/B/T02/2010/38.

REFERENCES

- [1] WEEE Directive, 2002/96/EC.
- [2] Act on Used Electrical and Electronic Equipment of 29th July 2005 (2005), Dziennik Ustaw nr 175 pozycja 1458, Warsaw.
- [3] Regulation of the Ministry of Environment off 15th of June 2009 on Calculating the Recovery and Recycling Level of Used Equipment (2009), Dziennik Ustaw nr 34 pozycja 241, Warsaw.
- [4] RoHS Directive, 2002/95/WE.
- [5] Maintenance manual of the electric kettle Zelmer type 332/332.2.