

# Probing Anomalous $WW\gamma$ and $WWZ$ Couplings with Polarized Electron Beam at the LHeC and FCC-Ep Collider

I. Turk Cakir, A. Senol, A. T. Tasci, O. Cakir

**Abstract**—We study the anomalous  $WW\gamma$  and  $WWZ$  couplings by calculating total cross sections of two processes at the LHeC with electron beam energy  $E_e=140$  GeV and the proton beam energy  $E_p=7$  TeV, and at the FCC-ep collider with the polarized electron beam energy  $E_e=80$  GeV and the proton beam energy  $E_p=50$  TeV. At the LHeC with electron beam polarization, we obtain the results for the difference of upper and lower bounds as (0.975, 0.118) and (0.285, 0.009) for the anomalous ( $\Delta\kappa_\gamma$ ,  $\lambda_\gamma$ ) and ( $\Delta\kappa_Z$ ,  $\lambda_Z$ ) couplings, respectively. As for FCC-ep collider, these bounds are obtained as (1.101, 0.065) and (0.320, 0.002) at an integrated luminosity of  $L_{int}=100$  fb $^{-1}$ .

**Keywords**—Anomalous Couplings, Future Circular Collider, Large Hadron electron Collider,  $W$ -boson and  $Z$ -boson.

## I. INTRODUCTION

THE  $SU(2)\times U(1)$  gauge symmetry of the Standard Model (SM) results in the triple gauge boson interactions. A precise determination of the trilinear gauge boson couplings is necessary to test the validity of the SM and the presence of new physics up to a high energy scale. Since the tree-level couplings of the  $WW\gamma$  and  $WWZ$  vertices are fixed by the SM, any deviations from their SM values would indicate the new physics beyond the SM. The photoproduction of the  $W$  and  $Z$  bosons through triple gauge boson interactions in the lepton-hadron colliders HERA+LC and in the Large Hadron electron Collider (LHeC) has been studied theoretically in the papers [1]-[3] and [4], respectively. An investigation of the potential of the LHeC to probe anomalous  $WW\gamma$  coupling has been presented in [5], [6].

The present bounds on the anomalous  $WW\gamma$  and  $WWZ$  couplings are provided by the LEP [7], Tevatron [8], [9] and LHC [10], [11] experiments.

Recently, the ATLAS [10], [11] and CMS [12], [13] Collaborations have established updated constraints on the anomalous  $WW\gamma$  and  $WWZ$  couplings from the  $\gamma W(Z)$  and  $W^+W^-$  production processes. The results from ATLAS and

I. Turk Cakir is with the Istanbul Aydin University, Applications and Research Center for Advanced Studies 34295, Sefakoy, Istanbul, Turkey (phone: +90-5333815529; fax: +90-212-4441428/22206; e-mail: ilkay.turkcakir@gmail.com).

A. Senol and A. T. Tasci are with Kastamonu University, Department of Physics, 37100, Kuzeykent, Kastamonu, Turkey (e-mail: asenol@kastamonu.edu.tr, atasci@kastamonu.edu.tr).

O. Cakir is with Istanbul Aydin University, Applications and Research Center for Advanced Studies 34295, Sefakoy, Istanbul, Turkey and Ankara University, Department of Physics, 06100, Tandogan, Ankara, Turkey (e-mail: ocakir@science.ankara.edu.tr).

CMS experiments based on two-parameter analysis of the anomalous couplings are given in Table I.

In this work, we investigate the  $ep\rightarrow\nu_e q\gamma X$  and  $ep\rightarrow\nu_e qZX$  processes with anomalous  $WW\gamma$  and  $WWZ$  couplings at the high energy electron-proton collider LHeC and FCC-ep (Future Circular Collider-electron proton) collider [14]. LHeC is considered to be realised by accelerating electrons 140 GeV and colliding them with the 7 TeV protons. We take into account the energies of the FCC-ep as 80 GeV for electron beam and 50 TeV for proton beam. We also consider the possibility of the electron beam polarization at LHeC [15] and FCC-ep which extends the sensitivity to anomalous triple gauge boson couplings.

TABLE I  
THE AVAILABLE 95% C.L. TWO-PARAMETER BOUNDS ON ANOMALOUS COUPLINGS ( $\Delta\kappa_\gamma$ ,  $\lambda_\gamma$ ) AND ( $\Delta\kappa_Z$ ,  $\lambda_Z$ ) FROM THE ATLAS AND CMS EXPERIMENTS

	ATLAS	CMS	ATLAS (upper-lower)	CMS (upper-lower)
$\Delta\kappa_\gamma$	-0.420,0.480	-0.250, 0.250	0.900	0.500
$\lambda_\gamma$	-0.068,0.062	-0.050, 0.042	0.130	0.092
$\Delta\kappa_Z$	-0.045,0.045	-0.160, 0.180	0.090	0.340
$\lambda_Z$	-0.063,0.063	-0.055, 0.055	0.126	0.110

## II. ANOMALOUS COUPLINGS

The  $WW\gamma$  and  $WWZ$  interaction vertices are described by an effective Lagrangian with the coupling constants  $g_{WW\gamma}$  and  $g_{WWZ}$  and dimensionless parameter pairs ( $\Delta\kappa_\gamma, \lambda_\gamma$ ) and ( $\Delta\kappa_Z, \lambda_Z$ )

$$L = ig_{WW\gamma}[g_1^\gamma(W_{\mu\nu}^+W^\mu A^\nu - W^{\mu\nu}W_\mu^+A_\nu) + \kappa_\gamma W_\mu^+W_\nu A^{\mu\nu} + \frac{\lambda_\gamma}{m_W^2}W_\rho^+W_\nu^\mu A^{\nu\rho}] + ig_{WWZ}[g_1^Z(W_{\mu\nu}^+W^\mu Z^\nu - W^{\mu\nu}W_\mu^+Z_\nu) + \kappa_Z W_\mu^+W_\nu Z^{\mu\nu} + \frac{\lambda_Z}{m_Z^2}W_\rho^+W_\nu^\mu Z^{\nu\rho}] \quad (1)$$

where  $g_{WW\gamma} = g_e = g \sin \theta_W$  and  $g_{WWZ} = g \cos \theta_W$ . In general these vertices involve six C and P conserving couplings [16]. However, the electromagnetic gauge invariance requires that  $g_1^\gamma = 1$ . The anomalous couplings are defined as  $\kappa_\gamma = 1 + \Delta\kappa_\gamma$  where  $V=\gamma, Z$  and  $g_1^Z = 1 + \Delta g_1^Z$ . The  $W_{\mu\nu}^+$ ,  $Z_{\mu\nu}$  and  $A_{\mu\nu}$  are the field strength tensors for the  $W^-$  boson,  $Z^-$  boson and photon, respectively.

The one-loop corrections to the  $WW\gamma$  and  $WWZ$  vertices within the framework of the SM have been studied in [17]-[19]. These corrections to the  $\Delta\kappa_\gamma$  and  $\lambda_\gamma$  have been found to be of the order of  $10^{-2}$  and  $10^{-3}$ , respectively. The values of the

couplings  $\kappa_\gamma = \kappa_Z = 1$  and  $\lambda_\gamma = \lambda_Z = 0$  correspond to the case of the SM. Since unitarity restricts the  $WW\gamma$  and  $WWZ$  couplings to their SM values at very high energies, the triple gauge couplings are modified as  $\Delta\kappa_V(q^2) = \Delta\kappa_V(0)/(1+q^2/\Lambda^2)^2$  and  $\lambda_V(q^2) = \lambda_V(0)/(1+q^2/\Lambda^2)^2$  where  $V = \gamma, Z$ . The  $q^2$  is the square of momentum transfer into the process and  $\Lambda$  is the new physics energy scale. The  $\Delta\kappa_V(0)$  and  $\lambda_V(0)$  are the values of the anomalous couplings at  $q^2=0$ . We assume the values of the anomalous couplings remain approximate constant in the interested energy scale ( $\Lambda^2 > q^2$ ). We take  $\Delta\kappa_V$  and  $\lambda_V$  as free parameters in the considered range and find the bounds on these couplings effectively. For the numerical calculations, we have implemented interactions terms in the CalcHEP [20].

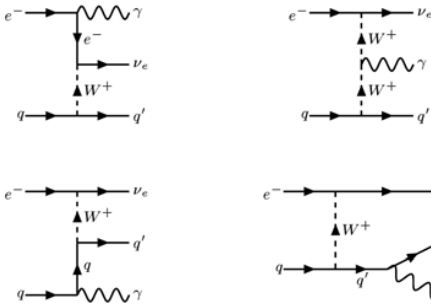

Fig. 1 Representative Feynman diagrams for subprocess  $eq \rightarrow \nu_e \gamma q'$

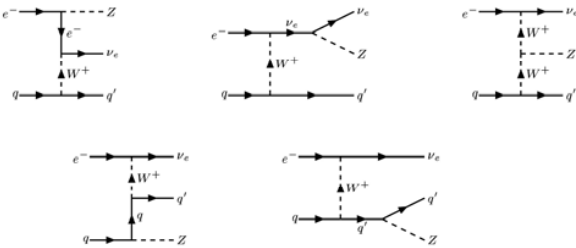

Fig. 2 Representative Feynman diagrams for subprocess  $eq \rightarrow \nu_e Z q'$

### III. PRODUCTION CROSS SECTIONS FOR LHEC

According to the effective Lagrangian, the anomalous vertices for triple gauge interactions  $WW\gamma$  and  $WWZ$  are presented in the Feynman graphs as shown in Figs. 1 and 2. In order to calculate the cross sections for the process  $ep \rightarrow \nu_e q\gamma X$  and  $ep \rightarrow \nu_e qZX$ , we apply the transverse momentum cut on photon and jet as  $p_T^\gamma > 50$  GeV,  $p_T^j > 20$  GeV; missing transverse momentum cut  $p_T^{\cancel{e}} > 20$  GeV, pseudorapidity cuts  $|\eta_{\gamma,j}| < 3.5$ ; a cone radius cut between photons and jets  $\Delta R_{\gamma,j} > 1.5$ . Using these cuts and the parton distribution functions of CTEQ6L [21], the total cross sections of the process  $ep \rightarrow \nu_e q\gamma X$  as a function of anomalous couplings  $\Delta\kappa_\gamma$  and  $\lambda_\gamma$  for  $E_e = 140$  GeV with electron beam polarizations  $P_e = \pm 0.8$  and  $P_e = 0$  are

presented in Figs. 3 and 4. In Figs. 5 and 6, the total cross sections of the  $ep \rightarrow \nu_e qZX$  process are given for the same energy. It is clear from these figures that the polarization ( $P_e = -0.8$ ) enhances the cross sections according to the unpolarized case.

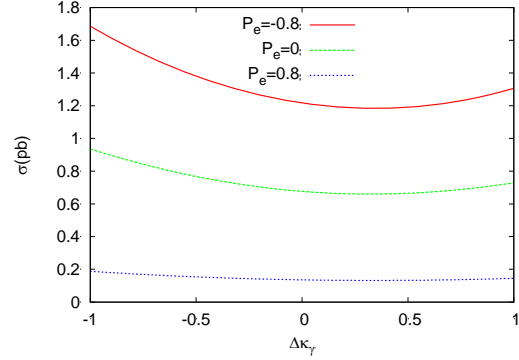

Fig. 3 The cross section depending on anomalous coupling  $\Delta\kappa_\gamma$  of the process  $ep \rightarrow \nu_e q\gamma X$  at  $E_e = 140$  GeV for different electron beam polarizations

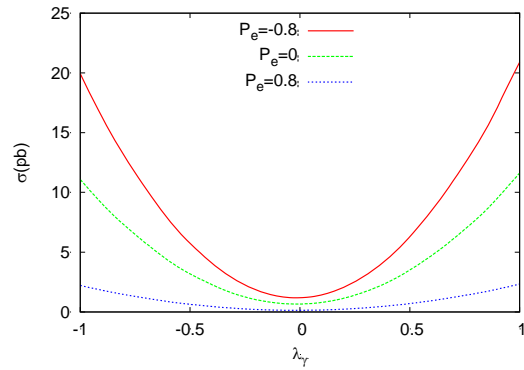

Fig. 4 The cross section depending on anomalous coupling  $\lambda_\gamma$  of the process  $ep \rightarrow \nu_e q\gamma X$  at  $E_e = 140$  GeV for different electron beam polarizations

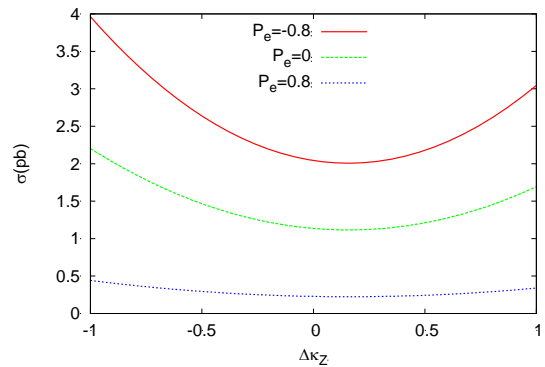

Fig. 5 The cross section depending on anomalous  $\Delta\kappa_Z$  coupling of the process  $ep \rightarrow \nu_e qZX$  for  $E_e = 140$  GeV

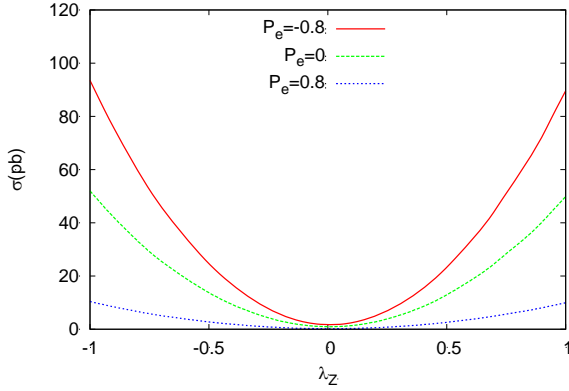

Fig. 6 The cross section depending on anomalous  $\lambda_Z$  coupling of the process  $ep \rightarrow \nu qZX$  for  $E_e = 140$  GeV

#### IV. ANALYSIS FOR LHEC

In order to estimate the sensitivity to the anomalous  $WW\gamma$  and  $WWZ$  couplings, we use the  $\chi^2$  function:

$$\chi^2(\Delta\kappa_V, \lambda_V) = \left( \frac{\sigma_{SM} - \sigma(\Delta\kappa_V, \lambda_V)}{\Delta\sigma_{SM}} \right)^2 \quad (2)$$

where  $\Delta\sigma_{SM} = \sigma_{SM} \sqrt{\delta_{stat}^2}$  with  $\delta_{stat} = 1/\sqrt{N_{SM}}$  and  $N_{SM} = \sigma_{SM} L$ . In our calculations, we consider that two of the couplings  $(\Delta\kappa, \lambda)$  are assumed to deviate from their SM value. We estimate the sensitivity to the anomalous couplings at 95 C.L. at the LHeC for the integrated luminosities of  $10 \text{ fb}^{-1}$  and  $100 \text{ fb}^{-1}$ . The contour plots of anomalous couplings in  $\Delta\kappa_\gamma - \lambda_\gamma$  plane for the integrated luminosities of  $10 \text{ fb}^{-1}$  and  $100 \text{ fb}^{-1}$  at electron beam energies  $E_e = 140$  GeV are given in Fig. 7. The contour plots of anomalous couplings in  $\Delta\kappa_Z - \lambda_Z$  plane for the integrated luminosities of  $10 \text{ fb}^{-1}$  and  $100 \text{ fb}^{-1}$  at electron beam energies of  $E_e = 140$  GeV are shown in Fig. 8.

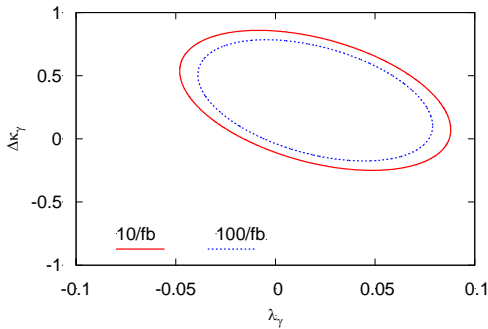

Fig. 7 Two dimensional 95% C.L. contour plot anomalous couplings in the  $\lambda_\gamma - \Delta\kappa_\gamma$  plane for the integrated luminosity of  $10 \text{ fb}^{-1}$  and  $100 \text{ fb}^{-1}$  at electron beam energy  $E_e = 140$  GeV with polarization  $P_e = -0.8$

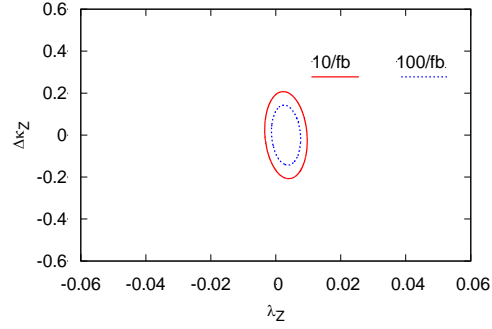

Fig. 8 Two-dimensional 95% C.L. contour plot of anomalous couplings in the  $\lambda_Z - \Delta\kappa_Z$  plane for the integrated luminosity of  $10 \text{ fb}^{-1}$  and  $100 \text{ fb}^{-1}$  at electron beam energy  $E_e = 140$  GeV with polarization  $P_e = -0.8$

The difference of the upper and lower bounds on the anomalous couplings  $\Delta\kappa_V$  and  $\lambda_V$  (where  $V = \gamma, Z$ ) can be written as

$$\delta\Delta\kappa_V = \Delta\kappa_V^{upper} - \Delta\kappa_V^{lower}, \delta\lambda_V = \lambda_V^{upper} - \lambda_V^{lower} \quad (3)$$

The current limits on anomalous couplings and the difference of the upper and lower bounds for electron beam energies of 140 GeV with integrated luminosities  $L_{int} = 10 \text{ fb}^{-1}$  and  $100 \text{ fb}^{-1}$  at LHeC with the unpolarized (polarized) electron beam are given in Table II. We have obtained two-parameter limits on  $\delta\Delta\kappa_\gamma$  and  $\delta\lambda_\gamma$  which can be compared to the ATLAS and CMS results. However, the limits on  $\delta\lambda_Z$  is found to be much more sensitive than the current limits.

TABLE II  
THE 95% C.L. CURRENT LIMITS ON THE ANOMALOUS COUPLINGS AND THE DIFFERENCE OF THE UPPER AND LOWER BOUNDS FOR ELECTRON BEAM ENERGY OF  $E_e = 140$  GeV WITH  $L_{int} = 100 \text{ FB}^{-1}$  FOR POLARIZED AND UNPOLARIZED ELECTRON BEAM

Pe	$\Delta\kappa_\gamma$	$\delta\Delta\kappa_\gamma$	$\lambda_\gamma$	$\delta\lambda_\gamma$
-0.8	-0.182, 0.793	0.975	-0.039, 0.079	0.118
0	0.192, 0.798	0.990	-0.041, 0.081	0.122
0.8	0.251, 0.844	1.095	-0.047, 0.086	0.133
Pe	$\Delta\kappa_Z$	$\delta\Delta\kappa_Z$	$\lambda_Z$	$\delta\lambda_Z$
-0.8	-0.143, 0.142	0.285	-0.001, 0.008	0.009
0	0.273, 0.089	0.362	-0.003, 0.009	0.012
0.8	0.253, 0.215	0.468	-0.004, 0.010	0.014

#### V. PRODUCTION CROSS SECTIONS FOR FCC-EP

For calculate the cross sections for the process  $ep \rightarrow \nu q\gamma X$  and  $ep \rightarrow \nu qZX$ , we apply the transverse momentum cut on photon and jet as  $p_T^\gamma > 20$  GeV,  $p_T^j > 20$  GeV; missing transverse momentum cut  $p_T^{\cancel{e}} > 20$  GeV, pseudorapidity cuts  $\eta_{\gamma, j}$  the range of between -5 and 0; Using these cuts and the parton distribution functions of CTEQ6M [14], the total cross sections of the process  $ep \rightarrow \nu q\gamma X$  as a function of anomalous couplings  $\Delta\kappa_\gamma$  and  $\lambda_\gamma$  for  $E_e = 80$  GeV with ( $P_e = \pm 0.8$ ) and

without ( $P_e=0$ ) electron beam polarization are presented in Figs. 9 and 10. It is clear from these figures that the polarization ( $P_e=-0.8$ ) enhances the cross sections according to the unpolarized case.

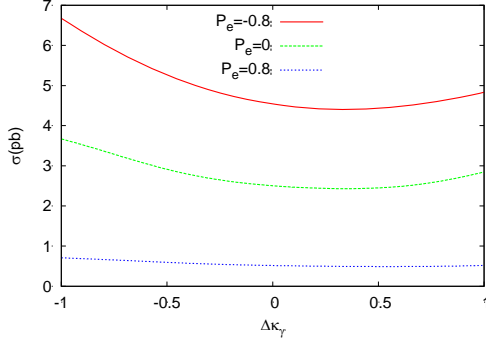

Fig. 9 The cross section depending on anomalous coupling  $\Delta\kappa_\gamma$  of the process  $ep \rightarrow \nu q\gamma X$  at  $E_e=80$  GeV for different electron beam polarizations

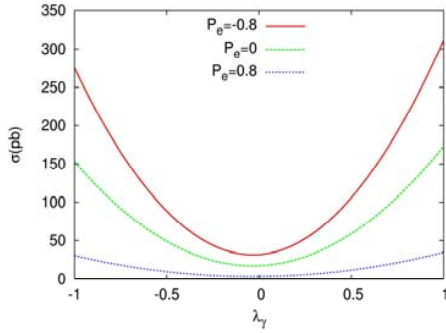

Fig. 10 The cross section depending on anomalous  $\lambda_\gamma$  coupling of the process  $ep \rightarrow \nu q\gamma X$  for  $E_e=80$  GeV

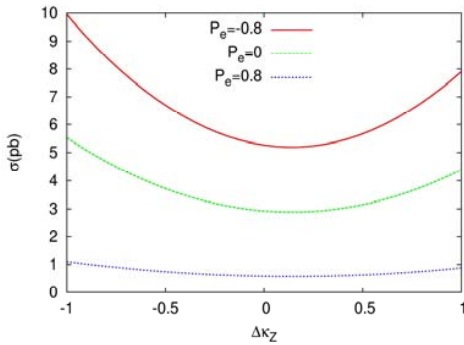

Fig. 11 The cross section depending on anomalous  $\Delta\kappa_Z$  coupling of the process  $ep \rightarrow \nu qZX$  for  $E_e=80$  GeV

The cross sections depending on anomalous couplings  $\Delta\kappa_Z$  and  $\lambda_Z$  of the process  $ep \rightarrow \nu qZX$  for  $E_e=80$  GeV with  $P_e=\pm 0.8$

and without ( $P_e=0$ ) electron beam polarization are presented in Figs. 11 and 12.

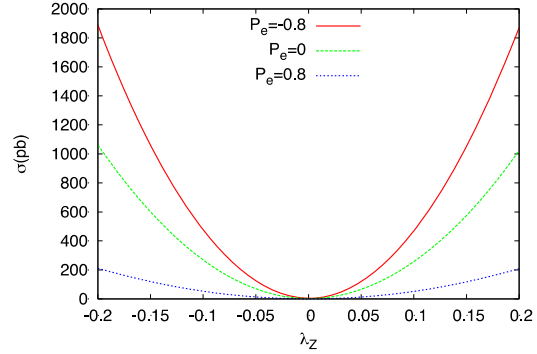

Fig. 12 The cross section depending on anomalous  $\lambda_Z$  coupling of the process  $ep \rightarrow \nu qZX$  for  $E_e=80$  GeV

## VI. ANALYSIS FOR FCC-EP

The contour plots of anomalous couplings in  $\Delta\kappa_\gamma$ - $\lambda_\gamma$  plane for the integrated luminosities of  $10 \text{ fb}^{-1}$  and  $100 \text{ fb}^{-1}$  at electron beam energies  $E_e=80$  GeV are given in Fig. 13. For the process  $ep \rightarrow \nu qZX$ , we make analysis of the signal and backgrounds when  $Z$  decays leptonically,  $Z \rightarrow l^+ l^-$  where  $l=e, \mu$ . The contour plots of anomalous couplings in  $\Delta\kappa_Z$ - $\lambda_Z$  plane for the integrated luminosities of  $10 \text{ fb}^{-1}$  and  $100 \text{ fb}^{-1}$  at electron beam energies of  $E_e=80$  GeV are presented in Fig. 14.

The difference of the upper and lower bounds on the anomalous couplings  $\Delta\kappa_V$  and  $\lambda_V$  (where  $V=\gamma, Z$ ) can be written as

$$\delta\Delta\kappa_V = \Delta\kappa_V^{upper} - \Delta\kappa_V^{lower}, \delta\lambda_V = \lambda_V^{upper} - \lambda_V^{lower} \quad (4)$$

The current limits on anomalous couplings and the difference of the upper and lower bounds for electron beam energies of  $E_e=80$  GeV with integrated luminosities  $100 \text{ fb}^{-1}$  at FCC-ep with the unpolarized (polarized) electron beam are given in Table III. We have obtained two-parameter limits on  $\delta\Delta\kappa_\gamma$  and  $\delta\lambda_\gamma$  which can be compared to the ATLAS and CMS results. However, the current limits on  $\delta\lambda_Z$  is found to be much more sensitive at the FCC-ep.

TABLE III  
THE 95% C.L. CURRENT LIMITS ON THE ANOMALOUS COUPLINGS AND THE DIFFERENCE OF THE UPPER AND LOWER BOUNDS FOR ELECTRON BEAM ENERGY OF  $E_e=80$  GeV WITH  $L_{int}=100 \text{ FB}^{-1}$  FOR POLARIZED ELECTRON BEAM

Pe	$\Delta\kappa_\gamma$	$\delta\Delta\kappa_\gamma$	$\lambda_\gamma$	$\delta\lambda_\gamma$
-0.8	-0.100:1.001	1.101	-0.026:0.039	0.0650
Pe	$\Delta\kappa_Z$	$\delta\Delta\kappa_Z$	$\lambda_Z$	$\delta\lambda_Z$
-0.8	-0.019:0.301	0.320	-0.0011:0.0012	0.0023

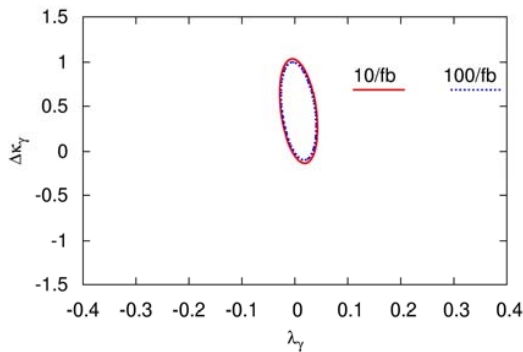

Fig. 13 Two dimensional 95% C.L contour plot anomalous couplings in the  $\lambda_\gamma - \Delta\kappa_\gamma$  plane for the integrated luminosity of  $10 \text{ fb}^{-1}$  and  $100 \text{ fb}^{-1}$  at electron beam energy  $E_e = 80 \text{ GeV}$  with polarization  $P_e = -0.8$

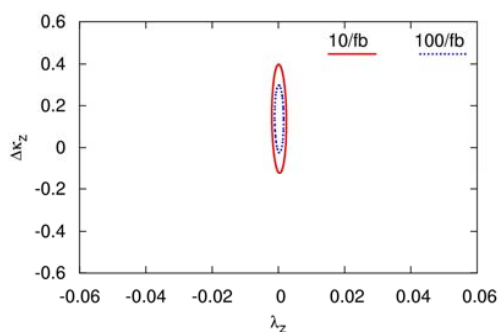

Fig. 14 Two-dimensional 95% C.L contour plot of anomalous couplings in the  $\lambda_Z - \Delta\kappa_Z$  plane for the integrated luminosity of  $10 \text{ fb}^{-1}$  and  $100 \text{ fb}^{-1}$  at electron beam energy  $E_e = 80 \text{ GeV}$  with polarization

## VII. CONCLUSION

The  $WW\gamma$  and  $WWZ$  anomalous interactions through the processes  $ep \rightarrow \nu_e q \gamma X$  and  $ep \rightarrow \nu_e q Z X$  can be studied independently at the LHeC and FCC-ep. We obtain two-parameter accessible ranges of triple gauge boson anomalous couplings at LHeC and FCC-ep with the polarized electron beam at the energies  $E_e = 140 \text{ GeV}$  and  $E_p = 7 \text{ TeV}$ , and  $E_e = 80 \text{ GeV}$  and  $E_p = 50 \text{ TeV}$ , respectively. Our limits compare with the results from two-parameter analysis given by ATLAS and CMS Collaborations [10]-[13]. We find that the sensitivities to anomalous couplings  $\Delta\kappa_V$  ( $V = \gamma, Z$ ) will be of the order of  $10^{-1}$ , which is an order of magnitude larger than the SM loop level sensitivity of  $10^{-2}$ , however a measurement of these couplings above  $10^{-2}$  would offer a possible new physics signal. We conclude that the anomalous couplings  $\lambda_\gamma$  and  $\lambda_Z$  can be well constrained with the sensitivity of the order of  $10^{-2}$  and  $10^{-3}$  at the FCC-ep with polarized electron beam. The LHeC and FCC-ep could give complementary information about anomalous couplings compared to Tevatron and LHC.

## ACKNOWLEDGMENT

The work of O.C. is partially supported by State Planning Organisation (DPT) - Ministry of Development under the grant No. DPT2006K-120470. A.S. would like to thank Abant Izzet Baysal University Department of Physics where of part this study was carried out for their hospitality

## REFERENCES

- [1] U. Baur, *et al.*, "Measuring the  $WW\gamma$  Vertex in Single W Production at ep Colliders", *Nucl. Phys. B*, vol.325, 1989, pp. 253.
- [2] C.S. Kim, *et al.*, "Photoproduction of massive gauge bosons in high-energy electron - proton collisions", *Z. Phys. C*, vol. 53, 1992, pp. 601-608.
- [3] S. Atag, *et al.*, "Anomalous WW gamma vertex in gamma p collision", *Phys. Rev. D*, vol. 63, 2001, pp. 033004.
- [4] C. Brenner Mariotto, *et al.*, "Analysis of the photoproduction of massive gauge bosons at the LHeC", *Phys. Rev. D*, vol. 86, 2012, pp. 033009.
- [5] S. Sudhansu Biswal, *et al.*, "Anomalous Triple Gauge Vertices at the Large Hadron-Electron Collider", arXiv:1405.6056 (hep-ph), 2014, pp. 11.
- [6] I.T. Cakir, *et al.*, "Search for Anomalous  $WW\gamma$  and  $WWZ$  couplings with polarized e-beam at the LHeC", *Acta. Phys. Pol. B*, vol. 45, 2014, pp. 1947-1962.
- [7] S. Schael, *et al.*, ALEPH and DELPHI and L3 and OPAL and LEP Electroweak Collaborations, "Electroweak Measurements in Electron-Positron Collisions at W-Boson-Pair Energies at LEP", *Phys. Rept.*, vol. 532, 2013, pp. 119-244.
- [8] T. Aaltonen, *et al.*, "CDF Collaboration, Measurement of the W+W- Production Cross Section and Search for Anomalous  $WW\gamma$  and  $WWZ$  Couplings in pp Collisions", *Phys. Rev. Lett.*, vol. 104, 2010, pp. 201801.
- [9] V.M. Abazov, *et al.*, D0 Collaboration, "Limits on anomalous trilinear gauge boson couplings from WW, WZ and  $W\gamma$  production in pp collisions at  $\sqrt{s} = 1.96 \text{ TeV}$ ", *Phys. Lett. B*, vol. 718, 2012, pp. 451-459.
- [10] G. Aad, *et al.*, ATLAS Collaboration, "Measurement of W+W- production in pp collisions at  $\sqrt{s} = 7 \text{ TeV}$  with the ATLAS detector and limits on anomalous WWZ and  $WW\gamma$  couplings", *Phys. Rev. D*, vol. 87, pp. 112001, 2013. Erratum-ibid. D, vol. 88, 2013, pp. 079906.
- [11] G. Aad, *et al.*, ATLAS Collaboration, "Measurements of  $W\gamma$  and  $Z\gamma$  production in pp collisions at  $\sqrt{s} = 7 \text{ TeV}$  with the ATLAS detector at the LHC", *Phys. Rev. D*, vol. 87, 2013, pp. 112003.
- [12] S. Chatrchyan, *et al.*, CMS Collaboration, "Measurement of the W+W- Cross section in pp Collisions at  $\sqrt{s} = 7 \text{ TeV}$  and Limits on Anomalous  $WW\gamma$  and  $WWZ$  couplings", *Eur. Phys. J. C*, vol. 73, 2013, pp. 2610.
- [13] S. Chatrchyan, *et al.*, CMS Collaboration, "Measurement of the W gamma and Z gamma inclusive cross sections in pp collisions at  $\sqrt{s} = 7 \text{ TeV}$  and limits on anomalous triple gauge boson couplings", *Phys. Rev. D*, vol. 89, 2014, pp. 092005.
- [14] FCC Collaboration, Future Circular Collider Study Kickoff Meeting, 2014.
- [15] J. L. Abelleira Fernandez, *et al.*, LHeC Study Group Collaboration, "A Large Hadron Electron Collider at CERN: Report on the Physics and Design Concepts for Machine and Detector", *J. Phys. G*, vol. 39, 2012, pp. 075001.
- [16] K. Hagiwara, *et al.*, "Probing the Weak Boson Sector in  $e^+ e^- \rightarrow W^+ W^-$ ", *Nucl. Phys. B*, vol. 282, 1987, pp. 253.
- [17] E. N. Argyres, *et al.*, "One loop corrections to three vector boson vertices in the Standard Model", *Nucl. Phys. B*, vol. 391, 1993, pp. 23.
- [18] P. Kalyniak, *et al.*, "Extracting W boson couplings from the  $e^+ e^-$  production of four leptons", *Phys. Rev. D*, vol. 48, 1993, pp. 5081-5092.
- [19] G. Couture, *et al.*, "Anomalous Magnetic and Quadrupole Moments of the W Boson in the Two Higgs Doublet Model", *Phys. Rev. D*, vol. 36, 1987, pp. 859.
- [20] A. Belyaev, *et al.*, "CalcHEP 3.4 for collider physics within and beyond the Standard Model", *Comput. Phys. Commun.*, vol. 184, 2013, pp. 1729-1769.
- [21] J. Pumplin, *et al.*, "New generation of parton distributions with uncertainties from global QCD analysis", *JHEP*, vol. 0207, 2002, pp. 012.