

# Performance of Power System Stabilizer (UNITROL D) in Benghazi North Power Plant

T. Hussein

**Abstract**—The use of power system stabilizers (PSSs) to damp power system swing mode of oscillations is practical important. Our purpose is to retune the power system stabilizer (PSS1A) parameters in Unitrol D produced by ABB— was installed in 1995 in Benghazi North Power Plants (BNPPs) at General Electricity Company of Libya (GECOL). The optimal values of the power system stabilizer (PSS1A) parameters are determined off-line by a particle swarm optimization technique (PSO). The objective is to damp the local and inter-area modes of oscillations that occur following power system disturbances. The retuned power system stabilizer (PSS1A) can cope with large disturbance at different operating points and has enhanced power system stability.

**Keywords**—Static excitation system, particle swarm optimization (PSO), power system stabilizer (PSS).

## I. INTRODUCTION

BENGHAZI north power plants (BNPPs) are the biggest power plants working in General Electricity Company of Libya (GECOL).

Excitation system [1] of the generators in BNPP was chosen for investigation because his work has the biggest impact on dynamic stability of the GECOL. A fast static excitation system (PID-system) UNITROL D [2] produced by ABB was installed in 1995.

Power systems are steadily growing with ever larger capacity. Formerly separated power systems are interconnected to each other. Modern power systems have evolved into systems of very large size. With growing generation capacity[3], different areas in a power system are added with even large inertia. As a consequence in large interconnected power systems, low frequency oscillations have an increasing importance.

The ability of a power system to maintain stability depends to a large of extent on the controls available on the system to damp the electromechanical oscillations [3]. Hence the study and design of controls are very important.

The basic function of an excitation system is to provide direct current to the field winding of the synchronous machine[1]. The protective functions ensure that capability limits of the synchronous machine, excitation system, and other equipment are not exceeded.

Tawfiq Hussein Elmenfy is with the Electrical Engineering Department, University of Benghazi, Benghazi, Libya (e-mail: tawfiq.elmenfy@benghazi.edu.ly).

The author thanks to the National Academy for Scientific Research (NASR) in Libya for financial support of this study.

The excitation system also performs control and protective functions important for satisfactory performance of the power system by controlling the field voltage and by that the field current. The control functions include the control over voltage and reactive power flow, and the enhancement of system stability.

The power system stabilizer (PSS) uses auxiliary stabilizing signal to control the excitation system so as to enhance damping of power system oscillations through excitation control. Commonly used inputs are shaft speed, terminal frequency, and power. Where frequency is used as an input, it will normally be terminal frequency, but in some cases a frequency behind a simulated machine reactance (equivalent to shaft speed for many studies) may be employed.

The Power System Stabilizer (PSS) is used to improve the damping of the power system oscillations and the general stability of the power generation including transmission system. By means of power system oscillations, two modes of oscillations are to be considered; “Local plant oscillations“ with typical range of oscillations from 0.8 to 2.0 Hz and “Inter-area oscillations“ with typical range of oscillations from 0.1 to 0.7 Hz.

The parameter of the power system stabilizers (PSS1A) was tuned in 1995 based on the power system structure in that time. Power systems are steadily growing with ever large capacity. Furthermore an oscillations in speed and active power are noted in Benghazi North Power Plant number three following large disturbance occurred at transmission line.

In this paper, particle swarm optimization technique (PSO) [5] is used to search for the optimal values of the power system stabilizer(PSSIA) parameters.

The effectiveness of the IEEE standard PSS1A [2] is illustrated by applying the PSS1A to single machine infinite bus.

## II. ST1A EXCITATION SYSTEM MODE

The computer model of the fast static exciter potential-source controlled-rectifier excitation system is shown in Fig. 1. Is intended to represent systems in which excitation power is supplied through a transformer from the generator terminals (or the unit’s auxiliary bus) and is regulated by a controlled rectifier [3]. The maximum exciter voltage available from such systems is directly related to the generator terminal voltage.

In this type of system, the inherent exciter time constants are very small, and exciter stabilization not required.

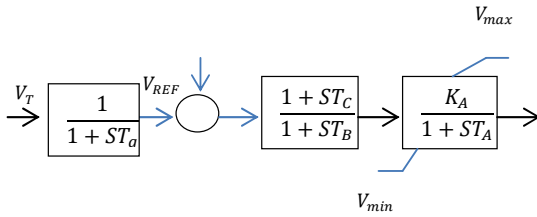

Fig. 1 Static fast exciter [2]

### III. TYPE PSS1A PSS MODEL

Fig. 2 shows the generalized form of a PSS1A with a single input [2]. Some common stabilizer input signals,  $V_{SI}$ , are speed, frequency, and power.  $T_6$  used to represent a transducer time constant. Stabilizer gain is set by the term  $K_S$  and signal washout is set by the time constant  $T_5$ .

In the next block,  $A_1$  and  $A_2$  allow some of the low- effects of high-frequency torsional filters (not used in these stabilizers). When not used for this purpose, the block can be used to assist in shaping the gain and phase characteristics of frequency the stabilize.

$V_{RMAX}$  &  $V_{RMIN}$  is stabilizer output limiter.

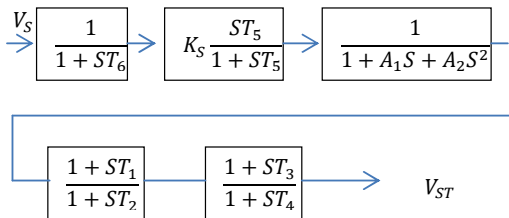

Fig. 2 Single input power system stabilizer type (PSS1A)[1]

### IV. OVERVIEW OF PARTICLE SWARM OPTIMIZATION (PSO)

The PSO concept [5] is to change the velocity of each particle toward its global ( $g_{best}$ ) and local ( $p_{best}$ ) locations at each iteration [5]. The modified velocity of each agent can be calculated using the current velocity and the distance from  $p_{best}$  and  $g_{best}$  as shown below:

$$v_i^{k+1} = w_i v_i^k + c_1 r \times (p_{best} - s_i^k) + c_2 r \times (g_{best} - s_i^k), \quad (1)$$

where,

$v_i^k$  : current velocity of particle  $i$  at iteration  $k$ ,

$v_i^{k+1}$  : modified velocity of particle  $i$ ,

$r$  : random number between 0 and 1,

$s_i^k$  : current position of particle  $i$  at iteration  $k$ ,

$p_{best}$  :  $p_{best}$  of particle  $i$ ,

$g_{best}$  :  $g_{best}$  of particle  $i$ ,

$w_i$  : weight function for velocity of agent  $i$ ,

$c_i$  : weight coefficient.

The current position (searching point in the solution space) can be modified by the following equation.

$$s_i^{k+1} = s_i^k + v_i^{k+1} \quad (2)$$

#### The PSO Algorithm

The proposed algorithm to search for the optimal value of the power system stabilizer (PSS1A) parameters using PSO can be summarized as follows:

1. Initialize the swarm with initial positions and velocities.
2. Calculate the fitness function of each particle by:

$$0.5 \times \sum (\omega - \omega_d)^2 \times t. \quad (3)$$

Where,

$\omega$  : actual speed

$\omega_d$  : desired speed

3. Determine  $p_{best}$  and  $g_{best}$  positions.
4. Update the particle velocity using (1).
5. Update the particle position using (2).
6. If the evaluation value of each particle is better than the previous  $p_{best}$ , the value is set to  $p_{best}$ . If the best  $p_{best}$  is better than  $g_{best}$ , the value is set to  $g_{best}$ .
7. If the iterations are exhausted, then go to step 8. Otherwise, go to step 2.
8. Plot  $p_{best}$ ,  $g_{best}$ .

We select the best one which has small error (3), sometimes we used the controller's gains which got by the PSO as reference values and decreasing the error by changing these gains by trial and error.

### V. SYSTEM DESCRIPTION

A three-phase generator rated 210 MVA, 15.75 kV, 3000 rpm is connected to a 230 kV, 10,000 MVA network through a Delta-star 210 MVA transformer.

At  $t = 0.1$  s, a three-phase to ground fault occurs on the 230 kV bus. The fault is cleared after 6 cycles ( $t = 0.2$  s).

During this system, we will initialize the system in order to start in steady-state with the generator supplying active power and observe the dynamic response of the machine speed deviation and of its active power.

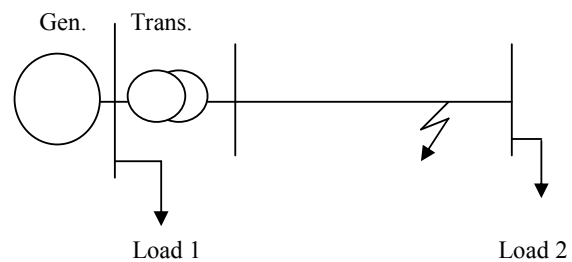

Fig. 3 Single machine infinite bus power system

### VI. SIMULATION STUDY (CASE STUDY)

The power system stabilizer (PSS1A) in Benghazi North Power Plant (BNPP) is implemented as shown in Fig. 4. Its parameters are tuned off-lines using the particle swarm optimization (PSO) algorithm, assuming the number of particles to ten and the weighting coefficients  $C_1 = 2$ ,  $C_2 = 2.5$ .

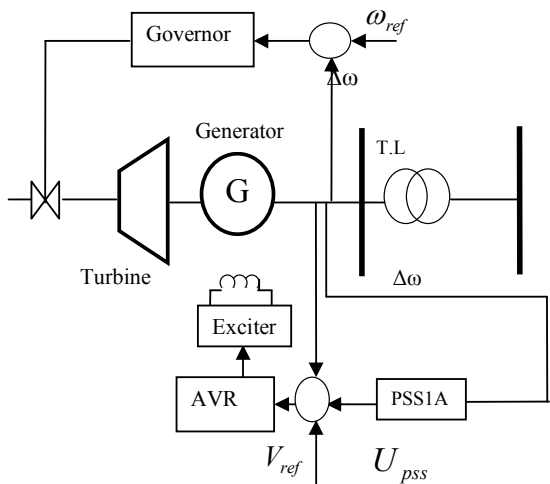

Fig. 4 Power system model used in study

The performance of the PSS1A in BNPP is evaluated by applying a large disturbance in the form of a three-phase fault of the transmission line. The fault occurs at 0.1 sec. and cleared at 0.2 sec.

Three different operating points are shown here to measure the performance of the power system stabilizer (PSS1A) in Unit1 D.

a) *Operating Point 1:*

$$P = 0.75 \text{ pu} \quad , \quad Q = 0.0123 \text{ pu}$$

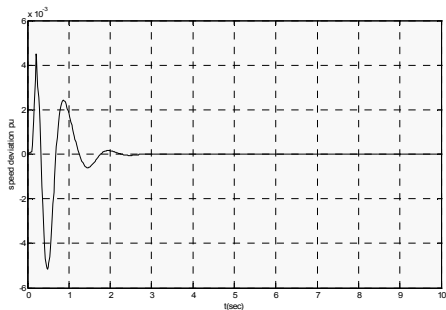

Fig. 5 Speed deviation for operating condition 1

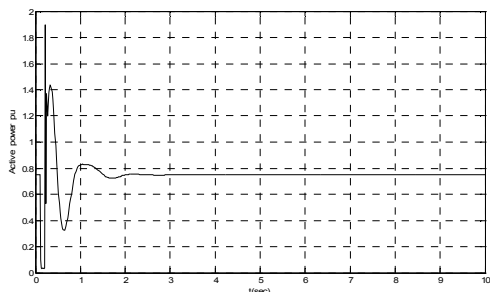

Fig. 6 Active power for operating point 1

b) *Operating Point 2:*

$$P = 0.95 \text{ pu} \quad , \quad Q = 0.025 \text{ pu}$$

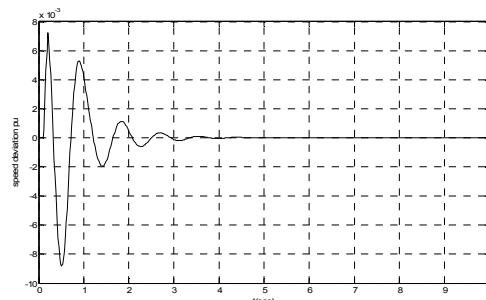

Fig. 7 Speed deviation for operating condition 2

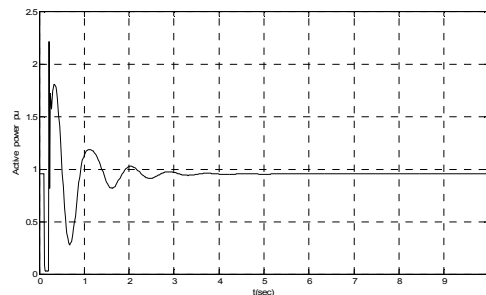

Fig. 8 Active power for operating point 2

c) *Operating Point 3:*

$$P = 0.47 \text{ pu} \quad , \quad Q = 0.001 \text{ pu}$$

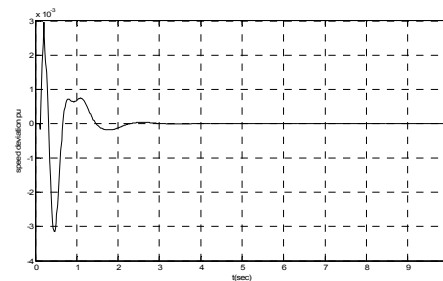

Fig. 9 Speed deviation for operating point 3

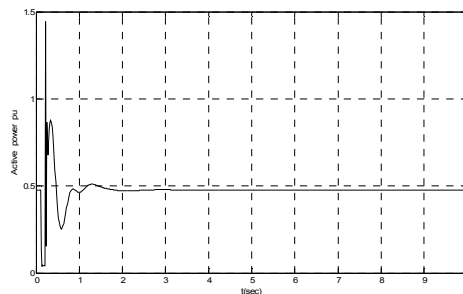

Fig. 10 Active power for operating point 3

As shown in the all figures for three operating points the one noted that, the damping stability is greatly improvement when used PSO to retune power system stabilizer parameters (PSS1A).

## VII. CONCLUSION

As power systems have evolved through continuing growth in interconnections, use of new technologies and controls, and the increased operation in highly stressed conditions, different forms of system instability have emerged. Many major trips caused by power system instability due to power system stabilizer which need retune to adapt to new interconnected power system. So our purpose is to retune the power system stabilizer (PSS1A) parameters in Unitrol D produced by ABB– was installed in 1995in Benghazi North Power Plant (BNPP) at General Electricity Company of Libya (GECOL). The optimal values of the PSS1A parameters are determined off-line by a particle swarm optimization technique (PSO). The objective is to damp the local oscillations that occur following power system disturbances.

The retuned power system stabilizer (PSS1A) can cope with large disturbance at different operating points and has enhanced power system stability.

## APPENDIX

The generator parameters in per unit on rated 210 MVA and 15.75 KV base are follow:

$$\begin{aligned}x_d &= 2.53 \text{ pu} & x_q &= 2.36 \text{ pu} \\x'_d &= 0.248 \text{ pu} & x'_q &= 0.4 \text{ pu} \\x''_d &= 0.187 \text{ pu} & x''_q &= 0.2 \text{ pu} \\T'_{do} &= 10.8 \text{ S} & R_s &= 0.001 \text{ pu} \\T''_{do} &= 0.03 \text{ S} & x_i &= 0.17 \text{ pu} \\T'_{qo} &= 0.99 \text{ S} \\T''_{qo} &= 0.034 \text{ S} \\H &= 1.29 \text{ S}\end{aligned}$$

Where:

- $x_i$  Leakage reactance
- $x_d$  d-axis synchronous reactance
- $x'_d$  d-axis transient reactance
- $x''_d$  d-axis subtransient reactance
- $x_q$  q-axis synchronous reactance
- $x'_q$  q-axis transient reactance
- $x''_q$  q-axis subtransient reactance
- $T'_{do}$  d-axis transient open-circuit time constant
- $T''_{do}$  d-axis subtransient open-circuit time constant
- $T'_{qo}$  q-axis transient open-circuit time constant

$T''_{qo}$  q-axis subtransient open-circuit time constant

$R_s$  stator resistance

$H$  moment of inertia time constant

## REFERENCES

- [1] Kundur P. "Power System Stability and Control" McGraw-Hill, 1994.
- [2] IEEE Recommended Practice for Excitation System Models for Power System Stability Studies, *IEEE Standard 421.5-2005, April 2006*.
- [3] M. Klein, G.J Rogers, P. Kundur" A fundamental Study of Inter-area Oscillations in Power Systems", *IEEE Trans. Power System* Volume 6, Number-3, August 1991, pp. 914-921.
- [4] H. J. Chow, E. G. Boukarim, and A. Murdoch" Power System Stabilizer as Undergraduate Control Design Project" *IEEE Transactions on power systems, vol.19.1, pp. 144-151 February 2004*.
- [5] J. Kennedy, and R. Eberhart" Particle Swarm Optimization" *Proceedings of IEEE International Conference on Neural Network, (ICNN), IV, Perth, Australia, pp. 1942-1948, Nov/ Dec.*

**T. Hussein-** received his B.Sc. degree in electrical engineering from Bright Star University of Technology, Brega, Libya, in 1991. From 1991 to 2003, he has been with General Electricity Company of Libya (GECOL). He then received the M.Sc. and Ph.D. degrees in electrical engineering from Cairo University, Egypt, in 2005, and 2009, respectively. Currently, he is a lecturer at the Electrical and Electronics Engineering Department in University of Benghazi, Benghazi, Libya. His research interests include adaptive control, fuzzy systems, and power system control.