

# Performance Evaluation of Intelligent Controllers for AGC in Thermal Systems

Muhammad Muhsin, Abhishek Mishra, Shreyansh Vishwakarma, K. Dasaratha Babu, Anudevi Samuel

**Abstract**—In an interconnected power system, any sudden small load perturbation in any of the interconnected areas causes the deviation of the area frequencies, the tie line power and voltage deviation at the generator terminals. This paper deals with the study of performance of intelligent Fuzzy Logic controllers coupled with Conventional Controllers (PI and PID) for Load Frequency Control. For analysis, an isolated single area and interconnected two area thermal power systems with and without generation rate constraints (GRC) have been considered. The studies have been performed with conventional PI and PID controllers and their performance has been compared with intelligent fuzzy controllers. It can be demonstrated that these controllers can successfully bring back the excursions in area frequencies and tie line powers within acceptable limits in smaller time periods and with lesser transients as compared to the performance of conventional controllers under same load disturbance conditions. The simulations in MATLAB have been used for comparative studies.

**Keywords**—Area Control Error, Fuzzy Logic, Generation rate constraint, Load Frequency, Tie line Power.

## I. INTRODUCTION

**R**ELIABILITY in Electrical power is required for proper functioning of an electric grid. It means that the frequency and voltage deviations should be within the specified limits [9]. In an interconnected power system, any sudden small load perturbation in any of the interconnected areas causes the deviation of the area frequencies, the tie line power and voltage deviation at the generator terminals. Automatic Generation Control (AGC) is hence used to maintain the desired megawatt output and the nominal frequency in an interconnected power system through Load Frequency control (LFC) and also the voltage deviation at the generator terminals with the help of Automatic Voltage Regulators (AVR). An AGC scheme for an interconnected power system basically incorporates suitable control system, which can bring the area frequencies, tie line powers, voltage deviations back to nominal or very close to nominal values effectively after the load perturbations.

Muhammad Muhsin is with the National Institute of Technology Goa, India (Phone: +91-9405920939; e-mail: psmuhsin@gmail.com).

Abhishek Mishra, Shreyansh Vishwakarma and K Dasaratha Babu are with the National Institute of Technology Goa, India. All are pursuing B.Tech in the Dept. of Electrical and Electronics Engineering.

Mrs. Anudevi Samuel is with the Faculty, Dept. of Electrical and Electronics Engineering at National Institute of Technology, Goa, India (e-mail: adsamuel@nitgoa.ac.in).

## II. AN OVERVIEW OF LOAD FREQUENCY CONTROL

### A. Need for Frequency Control

For large scale power systems which consist of interconnected control areas, it is important to keep the frequency and inter area tie power near to the scheduled values. The input mechanical power is used to control the power output and thus control the frequency. The change in the frequency and tie-line power are sensed, which is a measure of the change in rotor angle [6]. The reactive power is less sensitive to changes in frequency and is mainly dependent on fluctuations of voltage magnitude. So the control of the real and reactive power in the power system is dealt separately.

The main objectives of Load Frequency Control are:

- 1) To maintain the desired megawatt output and the frequency in an interconnected power system.
- 2) To maintain the net interchange of power between control areas at predetermined values.

In addition, the power system should fulfill the required dispatch conditions. A lot of studies have been made in the last two decades about the LFC in interconnected power systems [1]. Literature survey shows that only a few investigations have been carried out using Fuzzy Logic Controller (FLC) [12], [13]. The most widely employed one is the fixed gain controller, like integral controller or PI controller due to its low cost and high reliability in operation. Fixed gain controllers are designed at nominal operating points and may no longer be suitable in all operating conditions [11].

The real world power system contains different kinds of uncertainties due to load variations, system modeling errors and change of the power system structure. As a result, a conventional controller based on the classical theories is not suitable for the LFC problem. The conventional control strategy for the LFC problem is to take the integral of the area control error as the control signal. An integral controller provides zero steady state deviation but it exhibits poor dynamic performance [2], [3]. Consequently, it is required that a flexible controller be developed. In view of this, control strategy based on intelligent fuzzy controllers combined with conventional controllers has been proposed here.

### B. Single Area Control

The complete block diagram for single (isolated) area can be obtained by combining all the individual transfer function blocks of turbine, generator, governor and load as shown in Fig. 1. There are two important incremental inputs to the load frequency control system –  $\Delta P_c(s)$ , the change in speed changer setting and  $\Delta P_D$ , the change in load demand. A

situation where speed changer has a fixed setting [ $\Delta P_c(s) = 0$ ] and load demand  $\Delta P_D$  changes is called free governor operation. After performing steady state analysis on this system, the steady state change in system frequency is obtained as follows (after certain practical approximations)[7]:

$$\Delta f = \frac{1}{B + \left(\frac{1}{R}\right)} \Delta P \quad (1)$$

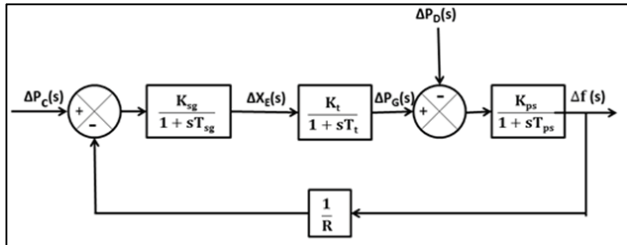

Fig. 1 Single Area Control Model

C. Multi Area Control

In case of an interconnected power system having two or more areas connected through tie lines, each area supplies its control area and tie lines allow electric power to flow among the areas. However, a load perturbation in any of the areas affects output frequencies of all the areas as well as the power flow on tie lines. Following are the basic operating principles of an interconnection of power systems [2]:

1. Under normal operating conditions, each control area should strive to carry its own load, except such scheduled portions of the other members' loads as have been mutually agreed upon.
2. Each control area must agree upon adopting regulating and control strategies and equipment that are mutually beneficial under both normal and abnormal situations.

Incremental power balance equation for area-1 can be written as [7]:

$$\Delta P_{G1}(s) - \Delta P_{D1}(s) = \frac{2H_1}{f_1} \frac{d}{dt} (\Delta f_1) + B_1 \Delta f_1 + \Delta P_{tie1} \quad (2)$$

Hence the change in frequency is given as shown in Fig. 2:

$$\Delta F_1(s) = [\Delta P_{G1}(s) - \Delta P_{D1}(s) - \Delta P_{tie1}(s)] \frac{K_{ps1}}{1 + sT_{ps1}} \quad (3)$$

Compared to single area,  $\Delta P_{tie1}$  is the only change in the above equation for two area where

$$\Delta P_{tie1}(s) = \frac{2\pi T_{12}}{s} [\Delta F_1(s) - \Delta F_2(s)] \quad (4)$$

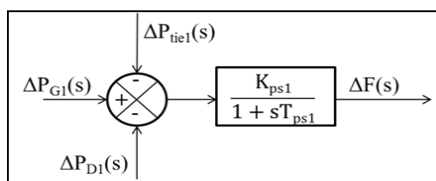

Fig. 2 Change in frequency for Two Area control

Similarly for control area 2,  $\Delta P_{tie2}(s)$  is as shown in Fig. 3:

$$\Delta P_{tie2}(s) = \frac{-2\pi a_{12} T_{12}}{s} [\Delta F_1(s) - \Delta F_2(s)] \quad (5)$$

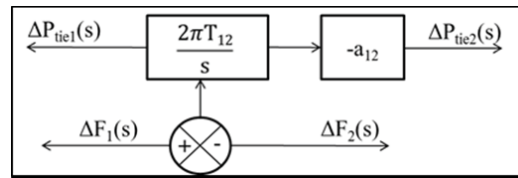

Fig. 3 Tie line power in Area-2

The load frequency control discussed so far does not consider the effect of the restrictions on the rate of change of power generation. In power systems having steam plants, power generation can change only at a specified maximum rate. Some have a generation rate between 5 to 10% per min. If these constraints are not considered, system is likely to chase large momentary disturbances [4]. This results in undue wear and tear of the controller. Several methods have been proposed to consider the effect of GRCs for the design of automatic generation controllers. When GRC is considered, the system dynamic model becomes non-linear [10].

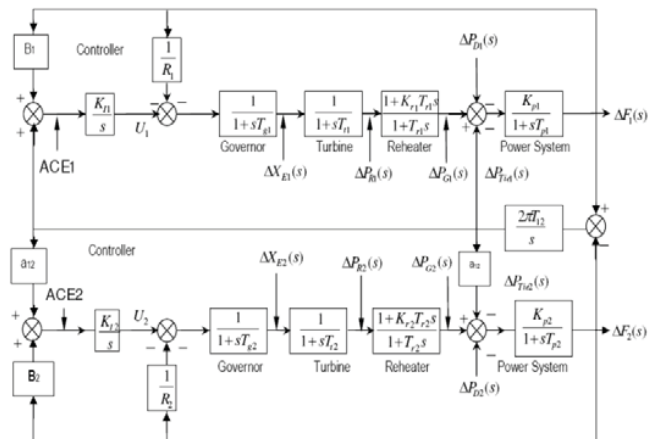

Fig. 4 Transfer Function Model for Two Area Thermal System

III. APPLICATION OF FUZZY CONTROL STRATEGY

It has been found that the amount of control required is easier for the operator to describe in terms of qualitative and symbolic forms. This automatically leads to a fuzzy-type solution whose strengths lie in the areas described. The fuzzy controller gives the opportunity to describe the control action in qualitative terms [13].

The basic idea behind the fuzzy rule set is that if the change in frequency ( $delf$ ) is found to be negative and its rate of change is also negative ( $deldelf$ ), the power supplied should be more in order to meet the excess demand and vice versa. However, in case the rate of change ( $deldelf$ ) is found to be positive, it is not required to increase the power generation by large amount. It can be varied slowly. This is very difficult to implement in a mathematical formula because slow is not an

exact number but a qualitative expression. Hence, a control strategy based on Fuzzy sets is implemented as in Table I.

The model as shown in Fig. 6 was used to implement intelligent control strategy.

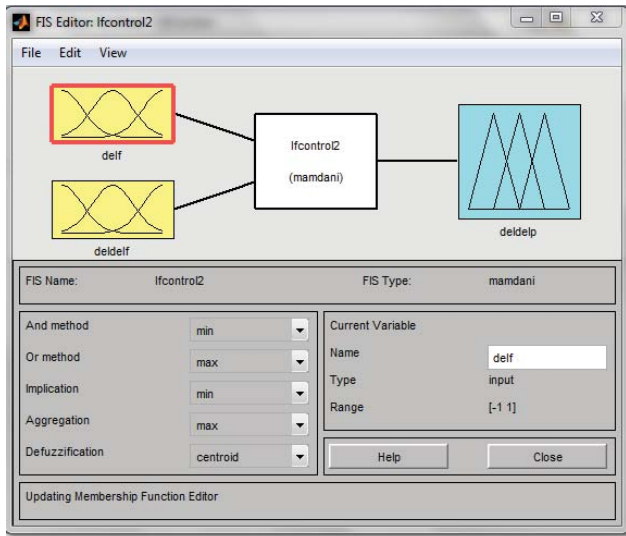

Fig. 5 (a) FIS Editor block in MATLAB

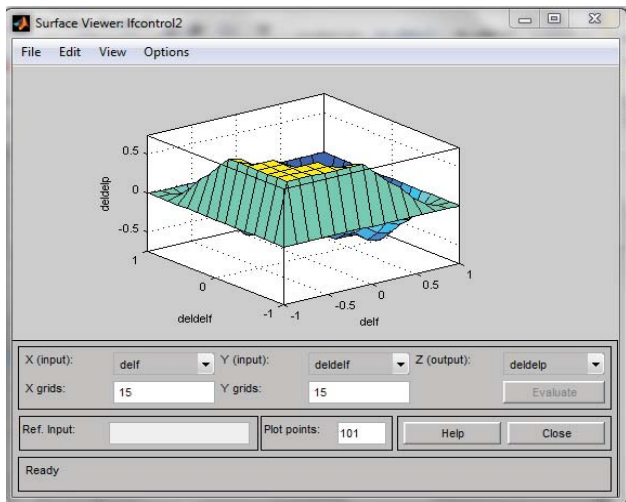

Fig. 5 (b) Output Surface Viewer in MATLAB

TABLE I  
FUZZY RULE BASE

deIdelf delf	NL	NM	NS	ZE	PS	PM	PL
NL	PL	PL	PL	PL	PM	PS	ZE
NM	PL	PL	PL	PM	PS	ZE	NS
NS	PL	PL	PM	PS	ZE	NS	NM
ZE	PL	PM	PS	ZE	NS	NM	NL
PS	PM	PS	ZE	NS	NM	NL	NL
PM	PS	ZE	NS	NM	NL	NL	NL
PL	ZE	NS	NM	NL	NL	NL	NL

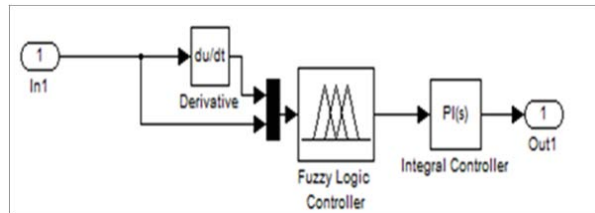

Fig. 6 Implementation of Fuzzy Logic Controller in MATLAB

#### IV. SIMULATION OUTPUTS

The parameters considered for simulation have been provided in Table II. The simulations were performed in MATLAB 2012 for the model shown in Fig. 4. The tuning of gains for conventional controllers was performed using PID tuner tool available in MATLAB.

TABLE II  
PARAMETERS USED FOR SIMULATION

Parameters	Single Area		Two Area	
	System 1	System 2	Area 1	Area 2
$T_{sg}$ (sec)	0.4	0.3	0.4	0.45
$T_t$ (sec)	0.36	0.2	0.36	0.5
$T_{ps}$ (sec)	20	20	20	22
$K_{sg}$	1	1	1	1
$K_t$	1	1	1	1
$K_{ps}$	125	125	125	100
(1/R) (p.u MW/Hz)	0.4	0.4	0.4	0.33

A. Single Area Control

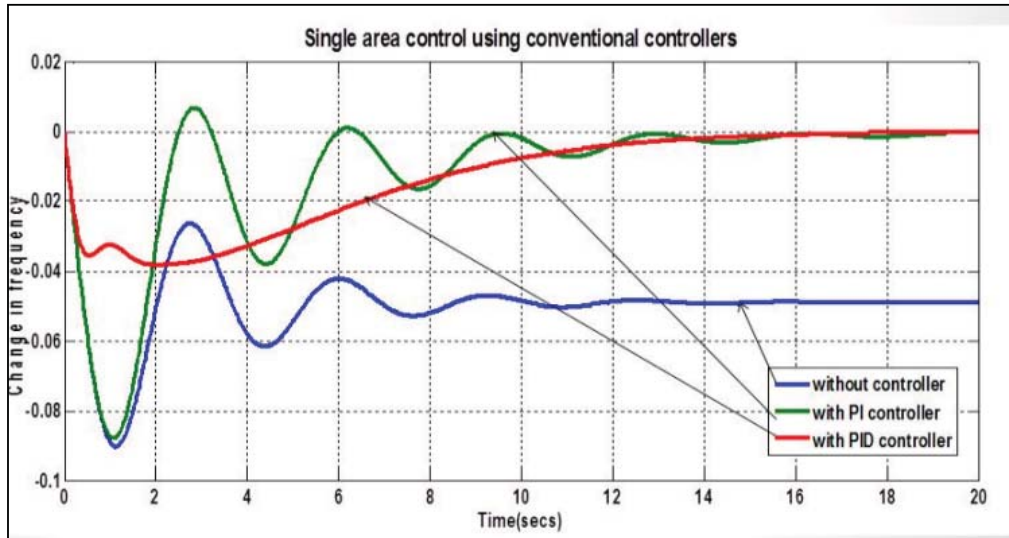

Fig. 7 (a) Using Conventional Controllers (Change in frequency vs. Time)

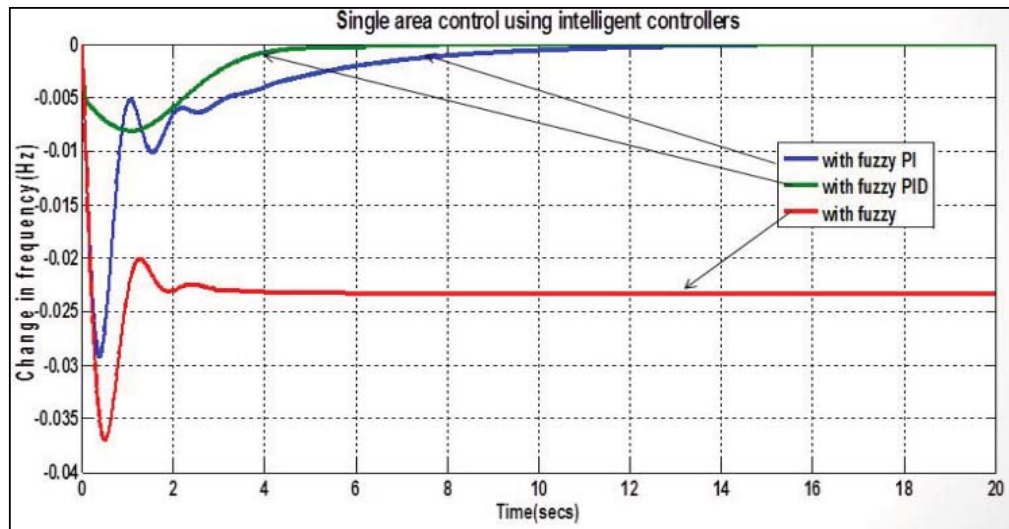

Fig. 7 (b) Using Intelligent Controllers (Change in frequency vs. Time)

B. Single Area Control with Multiple Generators

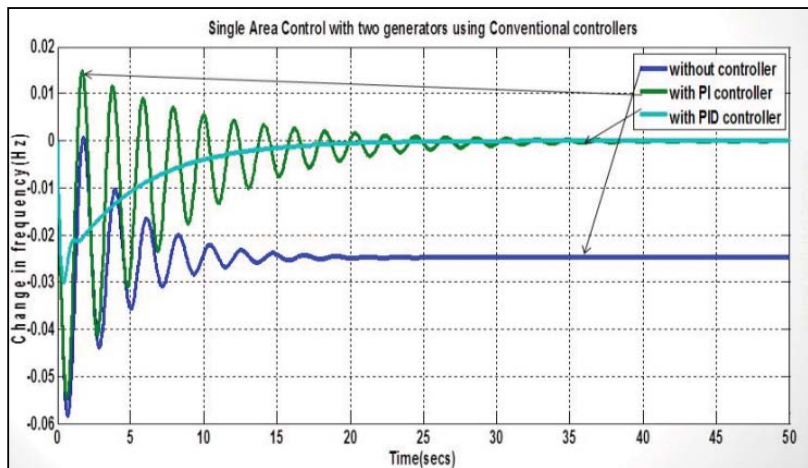

Fig. 8 (a) Using conventional controllers (Change in frequency vs. Time)

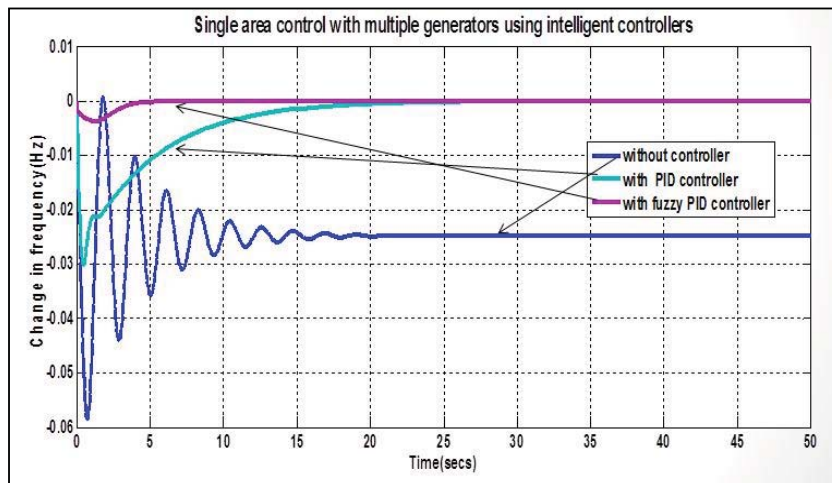

Fig. 8 (b) Comparison between conventional and intelligent controllers (Change in frequency vs. Time)

C. Single Area Control with Generation Rate Constraints

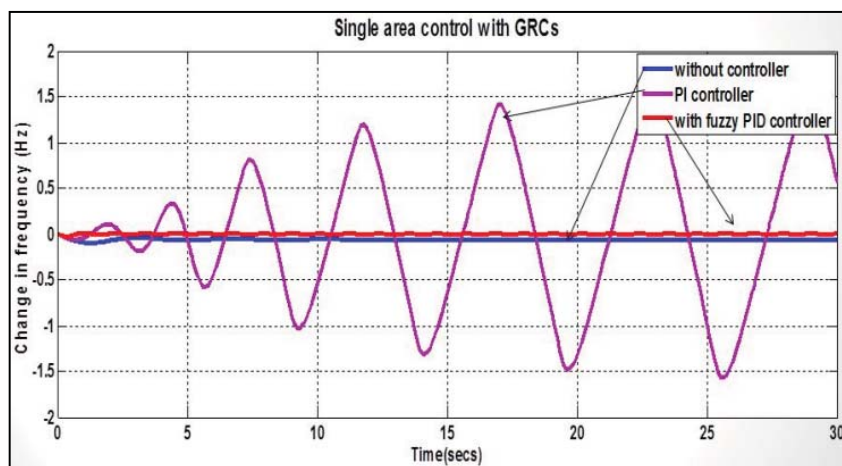

Fig. 9 Comparison between conventional and intelligent controllers (Change in frequency vs. Time)



D. Two Area Control with Change in Area-1

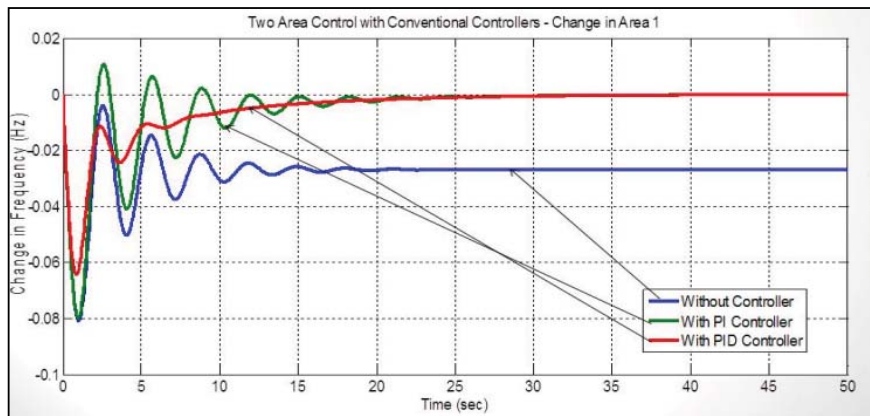

Fig. 10 (a) Using conventional controllers (Change in frequency vs. Time)

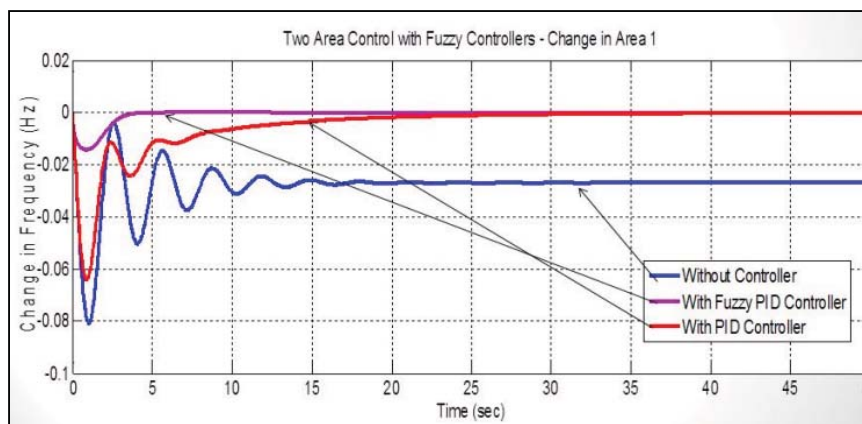

Fig. 10 (b) Comparison between conventional and intelligent controllers (Change in frequency vs. Time)

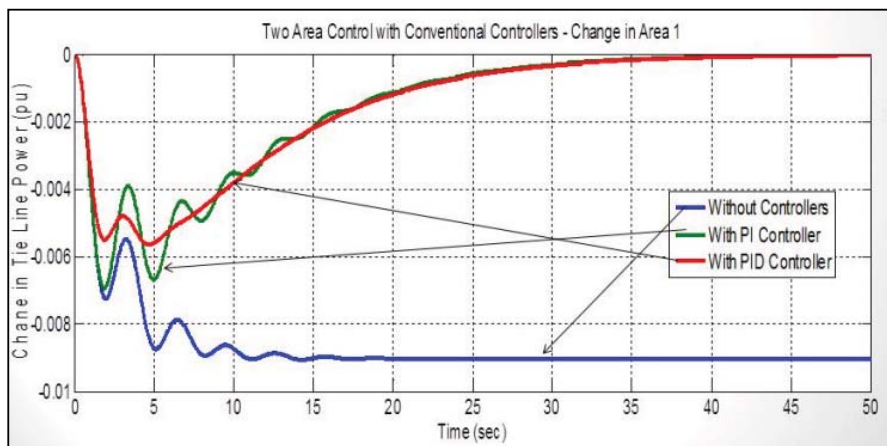

Fig. 10 (c) Using conventional controllers (Change in tie line power vs. Time)

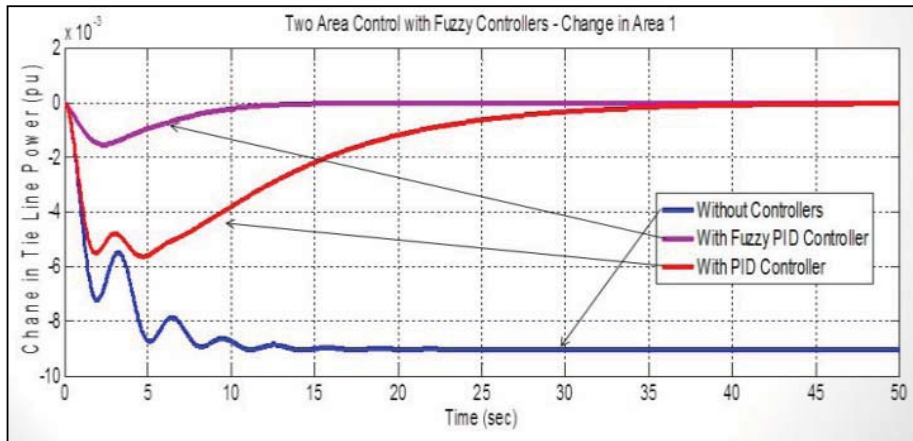

Fig. 10 (d) Comparison between conventional and intelligent controllers (Change in tie line power vs. Time)

E. Two Area Control with Change in Area-2

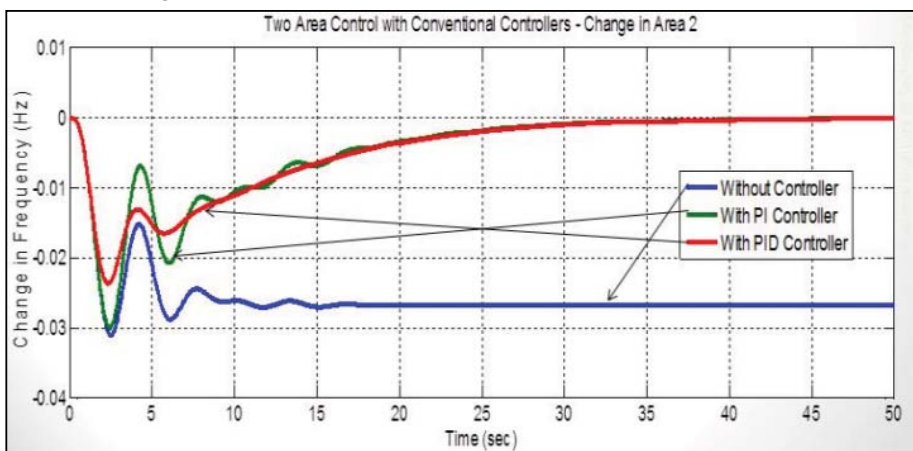

Fig. 11 (a) Using conventional controllers (Change in frequency vs. Time)

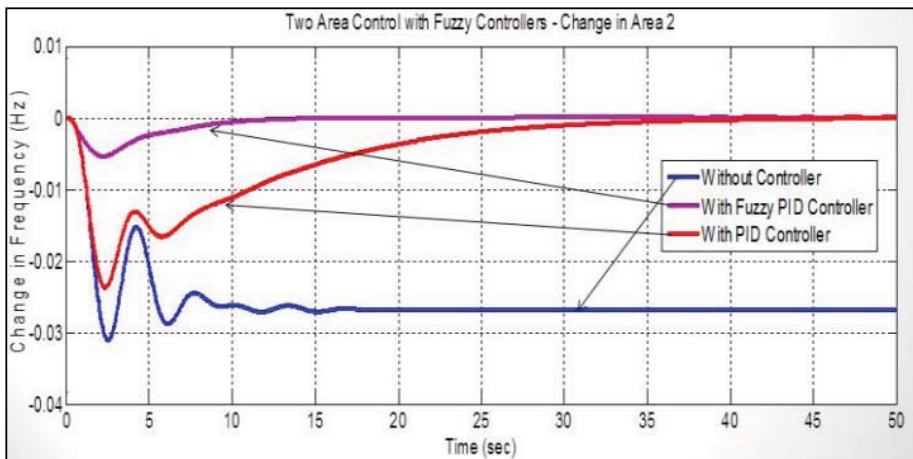

Fig. 11 (b) Comparison between conventional and intelligent controllers (Change in frequency vs. Time)

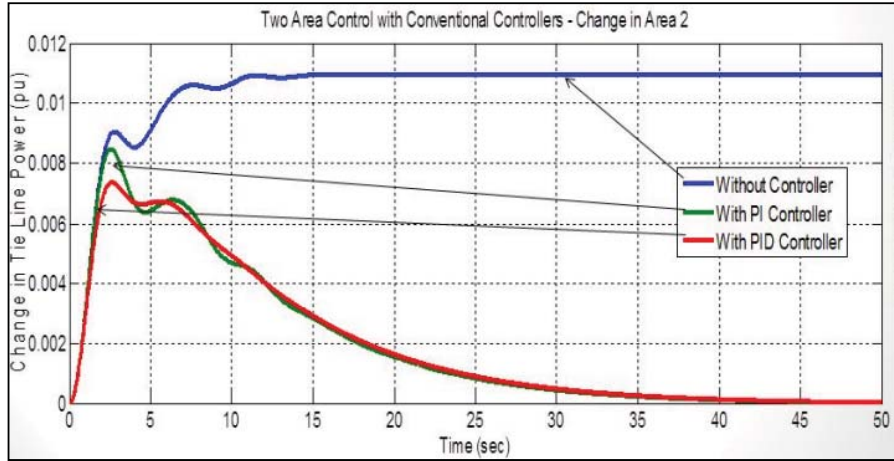

Fig. 11 (c) Using conventional controllers (Change in tie line power vs. Time)

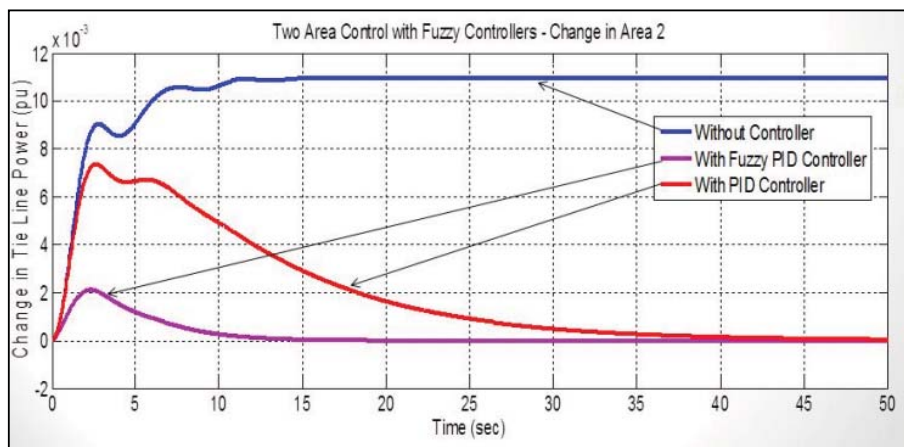

Fig. 11 (d) Comparison between conventional and intelligent controllers (Change in tie line power vs. Time)

V.RESULTS

The results obtained have been tabulated as shown.

TABLE III  
SETTLING TIME AND STEADY STATE ERROR FOR SINGLE AREA CONTROL

	Without Controller	PID	Fuzzy	Fuzzy PI	Fuzzy PID
Settling Time (sec)	18	16	5	12	6
Steady state error(p.u)	-0.05	0	-0.023	0	0

TABLE IV  
SETTLING TIME AND STEADY STATE ERROR FOR SINGLE AREA CONTROL WITH MULTIPLE GENERATORS

	Without Controller	PI	PID	Fuzzy PI	Fuzzy PID
Settling Time (sec)	25	50	23	12	7
Steady state error(p.u)	-0.025	0	0	0	0

TABLE V  
SETTLING TIME AND STEADY STATE ERROR FOR SINGLE AREA CONTROL WITH GENERATION RATE CONSTRAINTS

	Without Controller	PI	Fuzzy PID
Settling Time (sec)	2.7	Inf	1.3
Steady state error(p.u)	-0.05	Inf	0

TABLE VI  
SETTLING TIME AND STEADY STATE ERROR IN FREQUENCY AND TIE LINE POWER FOR TWO AREA CONTROL WITH CHANGE IN AREA 1

		Without Controller	PID	Fuzzy PI	Fuzzy PID
Settling time(sec)	Freq.	23	37	11	13
	Tie line Power	23	37	11	13
Steady State Error (p.u)	Freq.	-0.029	0	0	0
	Tie line Power	-0.009	0	0	0



TABLE VII  
SETTLING TIME AND STEADY STATE ERROR IN FREQUENCY AND TIE LINE POWER FOR TWO AREA CONTROL WITH CHANGE IN AREA 2

		Without Controller	PID	Fuzzy PI	Fuzzy PID
Settling time(sec)	Freq.	17	38	14	12
	Tie line Power	17	38	14	12
Steady State Error (p.u)	Freq.	-0.027	0	0	0
	Tie line Power	0.01	0	0	0

For single area control with single generator as shown in Fig. 12 (a) and Table III it is observed that using intelligent controllers there is improvement in the steady state and transient response of the system. As shown in Fig. 12 (a) using Fuzzy PID controllers there is reduction in the settling time 62.5% compared to conventional PID and the steady state error in frequency is also brought down to zero. In general with only fuzzy controllers, there is a reduction in the settling time. However, using only fuzzy controllers does not make steady state error zero. Hence they are coupled with conventional controllers to achieve that.

For single area control with multiple (two) generators also as shown in Fig. 12 (b) and Table IV it is observed that using intelligent controllers (Fuzzy PID) there is improvement in the steady state and transient response of the system. Using Fuzzy PID the settling time has reduced by 69%. However since there are two generators, for the same change in load  $\Delta P_D$  the system takes more time to settle.

For single area control with generation rate constraints as shown in Fig. 9 and Table V, it was observed that conventional controllers based on classical theory were not able to settle the error in frequency produced. Using Fuzzy PID controllers this was overcome.

For two area control, two cases have been studied. In each case, there is same change in load  $\Delta P_D$  given to one single area. It is found that in both cases using intelligent controllers (Fuzzy PID) there is improvement in the steady state and transient response of the system. For change in area 1, it is found that with an increase in load there is power flow in tie line from Area 2 to Area 1. Since in our analysis  $\Delta P_{tie\ 1-2}$  was assumed to be positive (in the modelling), the steady state error is found to be negative. This is illustrated in Figs. 10 (a)-(d) and Table VI. In this case using Fuzzy PI the system settled almost thrice faster compared to conventional PI. Similarly, for an increase in load demand in area 2, there is a drop in frequency. However, in this case since the flow of power is from area 1- area 2, the steady state error in tie line power is positive (as per our assumption). This is illustrated in Figs. 11 (a)-(d) and Table VII. In both cases considered it is found that there is a considerable change in the performance using intelligent Fuzzy controllers compared to the conventional PID controllers.

In all the cases studied, it is also found that the Fuzzy controller reduces the peak overshoots or undershoots in the system. Thus, even under load perturbations, it remains mostly within the allowable limit.

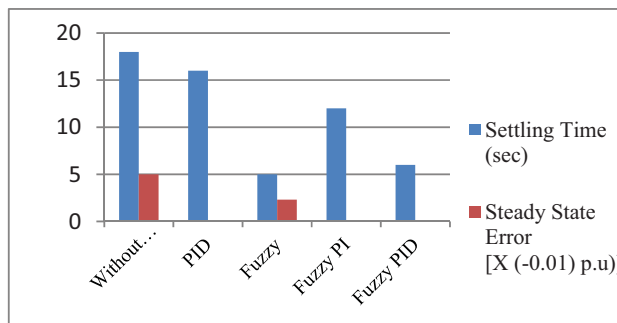

Fig. 12 (a) Comparison of different controllers for Single Area Control

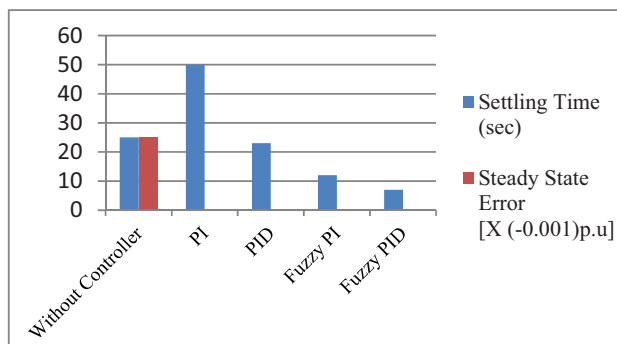

Fig. 12 (b) Comparison of different controllers for Single Area Control with Multiple Generators

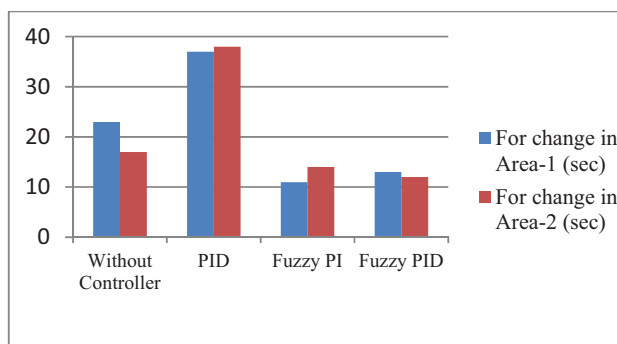

Fig. 12 (c) Comparison of different controllers in terms of Settling Time for Two Area Control

## VI. CONCLUSIONS

Load Frequency control for both single area and multi area have been studied for Thermal generating stations. The typical two area system has been simulated for different scheduled generations under different normal loading conditions with 2% step load disturbance in either area. The scheduled power

generations from thermal is adjusted to match the system normal operating load. It can be broadly concluded that using Fuzzy controllers coupled with conventional controllers the performance of the system can be improved. Following are some major conclusions:

- 1) In case of both single and two area, with increase in load in one area there is a drop in frequency in both areas. This is because the area with increase in load tries to demand power from the other area thus making a deficit of generated power in both areas. Due to this power transfer, the power through the tie line increases. Again, without controllers the frequency and tie line power do not return to their nominal value.
- 2) The PID controller is found to have better dynamic performance in most cases. It is advantageous in terms of settling time, overshoot, steady state value and oscillations. It has been found that the optimal gains of the controller are different for different loading conditions and systems [8].
- 3) To achieve better dynamic performance, the gains must be different for each source in an area. Therefore the selection of gains based on one typical nominal loading of the system and also by considering one source of power generation in area is not a realistic study [5]. Hence in realistic power system having diverse sources of power generation, the dynamics of all energy sources must be incorporated for controller design.
- 4) Conventional controllers being linear controllers do not respond well to the non-linearity in the system such as generation rate constraint.
- 5) Compared to intelligent Fuzzy controllers, the conventional controllers are slow in action.
- 6) Using only fuzzy controllers gives a steady state error. Hence, a conventional controller such as PI or PID is used along with it to make the steady state error zero.

#### APPENDIX

##### Parameters Used for Simulation

$$\Delta P_D = +0.02 \text{ pu}, a_{12} = -1$$

$$T_{12} = 0.08, B_1 = 0.425, B_2 = 0.326$$

$$\text{Saturation limits (for GRC)} = \pm 0.2$$

$$\text{Nominal Frequency} = 50 \text{ Hz}$$

#### REFERENCES

- [1] HosseinShayeghi, Heidar Ali Shayanfar and ArefJalili- "Multi Stage Fuzzy PID Load Frequency Controller in a Restructured Power System," Journal of Electrical Engineering, Vol. 58, NO. 2, 2007, 61–70.
- [2] Elgerd, O.I- "Electric Energy System Theory: An Introduction", McGraw-Hill, New Yourk, 1971.
- [3] Donde, V.Pai, M. A.Hiskens, "A.Simulation and Optimization in an AGC System after Deregulation," IEEE Trans. on Power systems 16 No. 3 (2001), 481–489.
- [4] Gayadhar Panda, Sidhartha Panda and CemalArdil- "Automatic Generation Control of Interconnected Power System with Generation Rate Constraints by Hybrid Neuro Fuzzy Approach," International Journal of Electrical and Electronics Engineering 3:9 2009.
- [5] K. S. S. Ramakrishna, Pawan Sharma, T. S. Bhatti "Automatic generation control of interconnected power system with diverse sources of power generation," International Journal of Engineering, Science and Technology Vol. 2, No. 5, 2010, pp. 51-65.
- [6] C P Bangal Thesis on "Automatic Generation Control of Interconnected Power Systems using Artificial Neural Network Techniques" Faculty of Engineering and Technology (Bharat University) May – 2009.
- [7] D P Kothari and I J Nagarath " Modern Power System Analysis," McGraw Hill Third Edition
- [8] Kallol Das, Priyanath Das, Sharmistha Sharma "Load Frequency Control Using Classical Controller in An Isolated Single Area and Two Area Reheat Thermal Power System," International Journal of Emerging Technology and Advanced Engineering Volume 2, Issue 3, March 2012
- [9] Central Electricity Authority, India [http://www.cea.nic.in/reports/regulation/grid\\_standards\\_reg.pdf](http://www.cea.nic.in/reports/regulation/grid_standards_reg.pdf)
- [10] Ignacio Egado, Fidel Fernández-Bernal, Luis Rouco, Eloisa Porras, and Ángel Sáiz-Chicharro- "Modeling of Thermal Generating Units for Automatic Generation Control Purposes," IEEE Transactions on Control Systems Technology, Vol. 12, No. 1, January 2004.
- [11] Gayadhar Panda, Sidhartha Panda and CemalArdil –"Automatic Generation Control of Interconnected Power System with Generation Rate Constraints by Hybrid Neuro Fuzzy Approach," International Journal of Electrical, Computer, Electronics and Communication Engineering Vol:3 No:4, 2009
- [12] J.Lee, "On methods for improving performance of PI-type fuzzy logic controllers", IEEE Trans. On Fuzzy Systems, Vol. 1, No. 4, pp. 298, Nov. 1993.
- [13] G.A.Chown and R.C.Hartman, "Design and experience with a Fuzzy Logic Controller for Automatic Generation Control (AGC)", IEEE Trans. Power Syst., Vol. 13, No. 3, pp. 965-970, Nov. 1998.



**Muhammad Muhsin** was born in Cochin, Kerala, India on 25<sup>th</sup> November 1992. He is currently pursuing B.Tech degree in Electrical and Electronics Engineering from National Institute of Technology, Goa. His Research interests include areas of Power Systems, Intelligent Controllers and Smart Grids. Some of his papers in these areas have been accepted for National and International conferences.



**Abhishek Mishra** was born in Mumbai, Maharashtra, India on 4<sup>th</sup> August 1992. He is currently pursuing B.Tech degree in Electrical and Electronics Engineering from National Institute of Technology, Goa. His Research interests include areas of Electromagnetism and Alternate Energy Sources.

**Shreyansh Vishwakarma** was born in Bhopal, Madhya Pradesh, India on 6<sup>th</sup> September 1991. He is currently pursuing B.Tech degree in Electrical and Electronics Engineering from National Institute of Technology, Goa. His Research interests include areas of Control Systems, Differential Calculus and Optimisation Techniques.



**K Dasaratha Babu** was born in Guntakal, Andhra Pradesh, India on 25<sup>th</sup> May 1993. He is currently pursuing B.Tech degree in Electrical and Electronics Engineering from National Institute of Technology, Goa. His Research interests include areas of Power Electronics and its Applications to Power Systems.



**Anudevi Samuel** was born in Tuticorin, Tamil Nadu on 10<sup>th</sup> April 1977. She obtained M.tech degree specialized in Power System Engineering from M K University in the year 1999. She is presently working as Faculty in Dept. of Electrical and Electronics Engineering at National Institute of Technology, Goa. Her research areas include Soft Computing Techniques in Power System and Control System. She has various papers published in National and International conferences.