

# Optimum Working Fluid Selection for Automotive Cogeneration System

Wonsim Cha, Kibum Kim, Kyungwook Choi and Kihyung Lee

**Abstract**—A co-generation system in automobile can improve thermal efficiency of vehicle in some degree. The waste heat from the engine exhaust and coolant is still attractive energy source that reaches around 60% of the total energy converted from fuel. To maximize the effectiveness of heat exchangers for recovering the waste heat, it is vital to select the most suitable working fluid for the system, not to mention that it is important to find the optimum design for the heat exchangers. The design of heat exchanger is out of scope of this study; rather, the main focus has been on the right selection of working fluid for the co-generation system. Simulation study was carried out to find the most suitable working fluid that can allow the system to achieve the optimum efficiency in terms of the heat recovery rate and thermal efficiency.

**Keywords**—Cycle Analysis, Heat Recovery, Rankine Cycle, Waste Heat Recovery, Working Fluid.

## I. INTRODUCTION

It has been recognized that an energy loss in modern engines reaching almost 60% is inevitable in spite of tremendous efforts to reduce the loss. Many researchers have focused on an optimization of the combustion process or the injection system; however, significance on more effective thermal management of engines has recently begun to emerge to reduction in CO<sub>2</sub> [1], [2].

In the light of effective thermal management of automotive engine, it was investigated whether a co-generation system could be applicable in automotive application. The engine exhaust can reach 700oC, which is a sufficient heat source for a Rankine system. However, the system size and weight can be as low as possible because there is not enough space to put this system in engine room. In addition, the system weight is directly associated with the fuel consumption of vehicle; the optimal design is necessary for the Rankine system[3]. The system size is also dependent on types of working fluid in Rankine system; therefore, selecting a working fluid for waste heat sources is significant[4], [5]. In this study, the effect of working fluid and system conditions (pressure, temperature) on the system efficiency was investigated for the optimal design of automotive cogeneration system using Cycle Tempo software.

Wonsim Cha is with Mechanical Engineering, Graduate School, Hanyang Univ., Korea (e-mail: pippi86@hanmail.net).

Kibum Kim is with Mechanical Engineering, Graduate School, Hanyang Univ., Korea (e-mail: kimkb11@gmail.com).

Kyungwook Choi is with Mechanical Engineering, Graduate School, Hanyang Univ., Korea (e-mail: encod.hanyang.ac.kr).

Kihyung Lee is with Department of Mechanical Engineering, Hanyang Univ., Korea (corresponding author to provide phone: +82-31-400-5251; fax: +82-31-400-4064; e-mail: hylee@hanyang.ac.kr).

## II. THERMAL EFFICIENCY OF RANKINE CYCLE

Figure 1 shows a simple ideal Rankine cycle that consists of a boiler, turbine, condenser and pump. Four processes occurring between each component are as follows:

- Process 1→2 : Isentropic compression in a pump
- Process 2→3 : Constant pressure heat addition in a boiler
- Process 3→4 : Isentropic expansion in a turbine
- Process 4→1 : Constant pressure heat rejection in a condenser

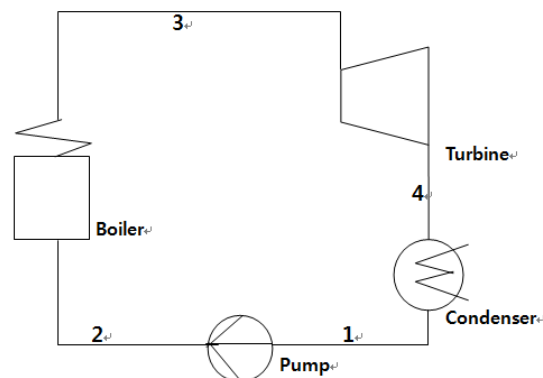

Fig. 1 Rankine Cycle

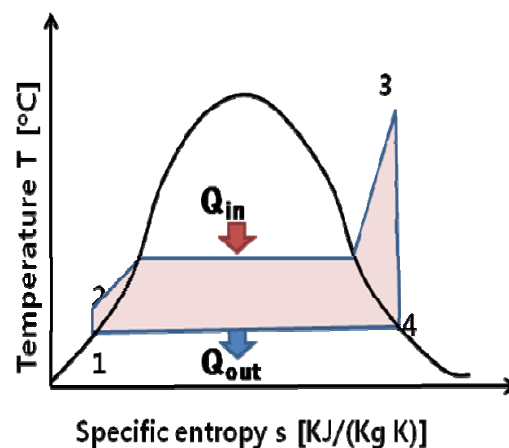

Fig. 2 T-s diagram

The processes are shown schematically on a T-s diagram in Figure 2, and thermal efficiency of a Rankine cycle is determined with Equation (1) through (5).

$$W_{in} = h_2 - h_1 \quad (1)$$

$$W_{out} = h_3 - h_4 \quad (2)$$

$$Q_{in} = h_3 - h_2 \quad (3)$$

$$Q_{out} = h_4 - h_1 \quad (4)$$

$$\eta_{ideal} = \frac{W_{out} - W_{in}}{Q_{in}} \quad (5)$$

In general, the basic idea behind all the modifications to improve the thermal efficiency of a power cycle is either increasing the average temperature at which heat is transferred to the working fluid in the boiler or decreasing the average temperature at which heat is rejected from the working fluid in the condenser. That is, the average fluid temperature should be as high as possible during heat addition and as low as possible during heat rejection.

### III. WORKING FLUID SELECTION

To select the most suitable working fluid for heat recovery from automobile engine exhaust and coolant, consideration should be given to the waste heat recovering rate, the system efficiency, system size, manufacturing costs, safety issues, and environmental factors. Thermodynamic properties of commonly used working fluids in thermal systems are summarized in Table 1. Water possesses optimal characteristics when a high quality heat source is available. In particular, the high latent heat of water is one of big advantage because the waste heat can be recovered with the low mass flow rate, resulting in the reduction in the thermal system including the heat exchanger. In addition to water, ethanol, R-245fa, and Ammonia were considered as a working fluid in Rankine system in this study.

For the optimal design of the waste heat recovery system, the maximum system temperature and pressure should be less than 350°C and 40 bar, respectively, from the system durability

TABLE I  
PROPERTIES OF WORKING FLUIDS

Item	Water	Ethanol	Ammonia	R245fa
$T_c$ [°C]	374.0	240.7	132.2	94.8
$P_c$ [bar]	220.6	61.4	113.3	32.6
$T_b$ [°C] <sup>a</sup>	100.0	78.4	-33.3	-29.2
$T_f$ [°C] <sup>a</sup>	0	-114.3	-77.7	-
$\Delta h$ [°C] <sup>a</sup>	2256.5	820.0	1369.5	178.2
$T$ [°C] <sup>b</sup>	244.5	138.0	51.2	21.2
$P$ [bar] <sup>b</sup>	36.2	7.2	21.0	6.0
$\Delta h$ [KJ/kg]	1743.0	721.5	1044.5	176.7

$\Delta h$  = latent heat [ kJ/kg],  $\eta$  = Rankine cycle efficiency,  $W$  = Work [kJ/kg],  
 $T$  = Temperature [ K],  $P$  = Pressure [bar], b = boiling, c = critical,  
 f = freezing

standpoint. The system minimum temperature of 65°C was chosen based on the system cooling capability. Therefore, the system minimum pressure was determined according to the system condensing temperature that varied with different working fluids leading to various system efficiencies.

#### A. Water

Water has a high latent heat of vaporization such that the water can recover the waste heat with a low mass flow rate. As mentioned above, the condensing temperature was chosen 65°C at which the condensing pressure was 0.25 bar. The system efficiency was evaluated while the boiler pressure is increased from 2.5 to 25 bars, as shown in Figure 3.

The efficiency was low with low superheating temperature, but it increased as the temperature is increased. The efficiency is over 27% at the system pressure of 25 bar, but it rapidly dropped when the superheating temperature was decreased below 220oC. Therefore, a proper boiler pressure in accordance to the heat recovery rate should be selected for obtaining the optimal efficiency.

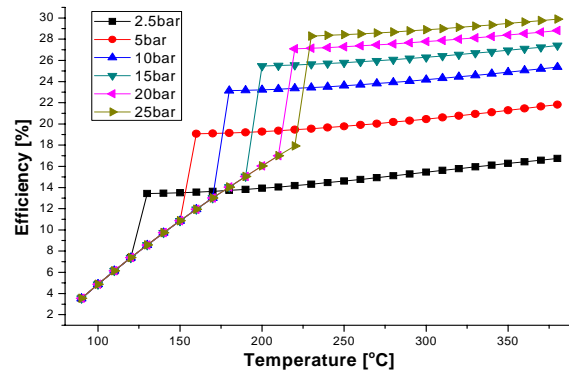

Fig.3 Cycle efficiency of a Rankine system with water as a working fluid

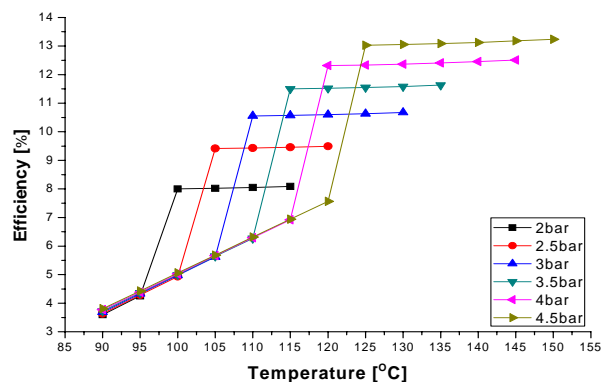

Fig.4 Cycle efficiency of a Rankine system with Ethanol as a working fluid

#### B. Ethanol

A cycle efficiency of a Rankine system with Ethanol as a working fluid is shown in Figure 4. The system efficiency increases as evaporation temperature and system pressure

increase. However, a flash point of ethanol is around 130°C such that it is dangerous to be used when the system pressure is over 4.5 bars. It is noted that the ethanol makes the cycle efficiency be higher at the range of the low evaporation temperature. It is concluded that ethanol is the better in terms of working fluid selection when low quality heat source is available

#### C. R245fa

Refrigerant 245fa has been widely used in various industrial areas for the waste heat recovery system. It is a dry-type working fluid, so its boiling temperature is relatively high compared with other common refrigerants. The condensing pressure was set at 5.3 bar to maintain the condensing temperature of 65°C. Figure 5 shows the thermal efficiency as a function of superheating temperature and pressure. The higher pressure leads to the better system efficiency; however, the system pressure was limited to 25 bars because the critical pressure of R-245fa is 36.4 bar. For each pressure, the efficiency reached its maximum and it gradually decreased.

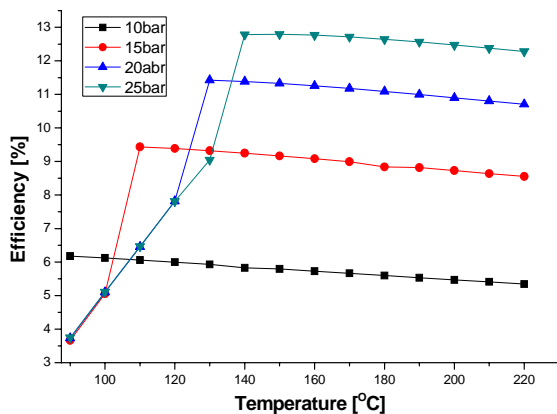

Fig.5 Cycle efficiency of a Rankine system with R-245fa as a working fluid

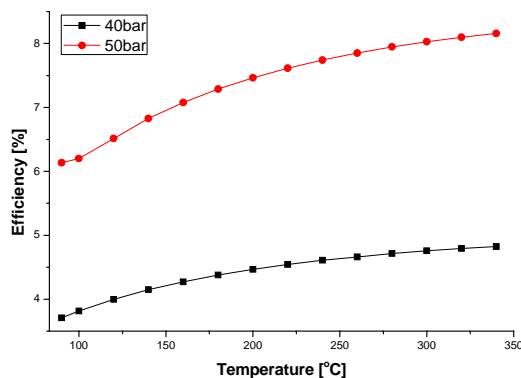

Fig.6 Cycle efficiency of a Rankine system with Ammonia as a working fluid

#### D. Ammonia

The latent heat of vaporization of Ammonia is high compared with other refrigerants, but the condensing pressure should be 29.5 bar to keep the condensing temperature at 65°C.

The efficiency is not as high as that of other working fluid, and it is toxic gas such that it might not be suitable working fluid to discuss in this study.

## IV. SYSTEM DESIGN

To maximize recovery rate of the waste heat in vehicle, the recovery system is better to be divided into two Rankine loops based on temperature range of the available heat sources. The heat from exhaust could be recovered using high temperature loop (HTL) and the heat from coolant could be recovered using low temperature loop (LTL). Based on our simulation results, the water is a favorable working fluid for the HTL and either ethanol or R-245fa is favorable for the LTL.

#### A. HT Loop

Since the temperature of engine exhaust that is a high quality energy source is around 500°C~600°C, water was selected as a working fluid for this loop. In general, the compression ratio of a Rankine system is 10, and thus, the maximum and minimum system pressures are chosen to evaluate the system efficiency as listed in Table 2. Furthermore, the superheated steam temperature at the exit of the boiler was ranged from 200 to 360°C. Figure 7 shows the cycle efficiency for three different sets of system pressure as the superheated steam temperature was increased.

As the boiler exit temperature was increased, the cycle efficiency rapidly increased, but it gradually increases when the temperature became over 260°C.

The system efficiency is proportional to the boiler pressure and temperature, but the optimum conditions need to be selected when the system size, weight, and manufacturing cost are considered. Therefore, the maximum system pressure of 30 bars and the system temperature of 260°C might be the optimum condition for the HT loop. In this case, the system efficiency was around 18.14%.

TABLE II  
SYSTEM PRESSURE AND TEMPERATURE FOR SIMULATION

$P_{eva}$ [bar]	$P_{cond}$ [bar]	$T_{cond}$ [°C]	$T_{max}$ [°C]
20	2	120.21	200
30	3	133.53	~360
40	4	143.81	

$P_{eva}$  = Evaporation Pressure,  $P_{cond}$  = Condensation Pressure,  $T_{cond}$  = Condensation Temperature,  $T_{max}$  = Maximum Temperature

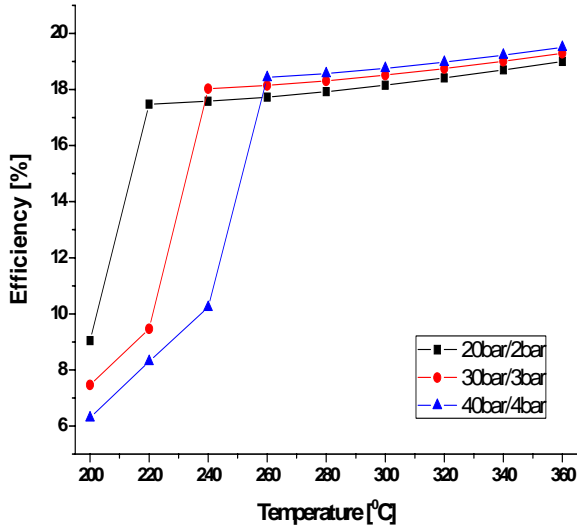

Fig.7 Cycle efficiency of a HT loop with water as a working fluid

*B. LT loop*

The heat source for LT loop is engine coolant which temperature is around 120°C. To investigate thermal efficiency of the system with ethanol and R-245fa as a working fluid, the superheating temperature was changed from 90oC to 120oC while the condensing temperature was fixed 65oC. Figure 8 shows the efficiency of LT loop with a heat exchanger having an effectiveness of 0.8. When ethanol was used for the working fluid, the maximum efficiency of 10.7% was obtained at the boiler pressure of 2 bars. On the other hands, the system efficiency was 8.3% with R-245fa at the boiler pressure of 12 bars. However, as the superheating temperature is decreased, the efficiency reduced to 4.7%. Rather, the system efficiency was higher at lower boiler pressures. Note that the coolant temperature highly relies on driving conditions of vehicles. Therefore, the boiler pressure does not necessary to be maximized in this case.

The exhaust temperature passed through a heat exchanger in HT loop is still high enough to be utilized for heat source for HT loop. Figure 9 and 10 show the efficiency of the LT system using two heat sources from both exhaust and coolant. In case that the superheating temperature was 150oC, the efficiency was 13.2% at the system pressure of 4.5 bar for ethanol while it was 12.8% for R-245fa.

The complete system that has combined HTL and LTL is shown in Figure 11 and specific system conditions are listed in Table 3. Based on the simulation conditions, the efficiency of HT loop and LT loop were 16.83% and 17.66%, respectively. The chosen working fluids were water for HT loop and R-245fa for LT loop

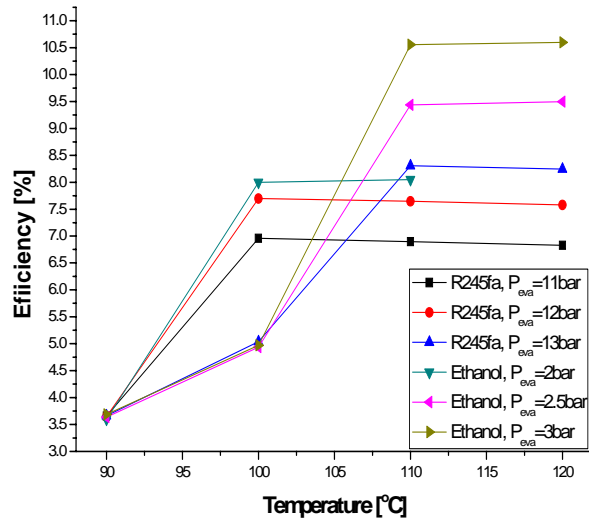

Fig.8 Cycle efficiency of LT loop with ethanol and R-245fa

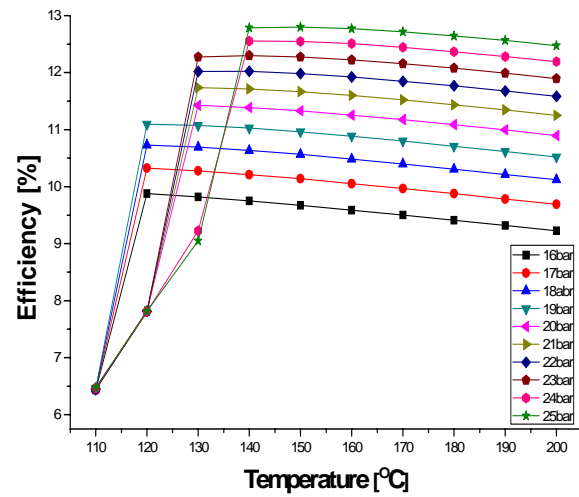

Fig. 9 Cycle efficiency of LT loop with R245fa

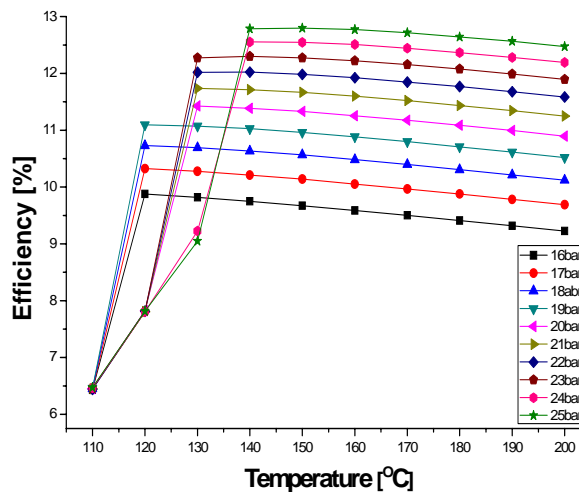

Fig. 10 Cycle efficiency of LT loop with ethanol

The exhaust temperature passed through a heat exchanger in HT loop is still high enough to be utilized for heat source for HT loop. Figure 9 and 10 show the efficiency of the LT system using two heat sources from both exhaust and coolant. In case that the superheating temperature was 150oC, the efficiency was 13.2% at the system pressure of 4.5 bar for ethanol while it was 12.8% for R-245fa.

### C. Dual combined system

The complete system that has combined HTL and LTL is shown in Figure 11 and specific system conditions are listed in Table 3. Based on the simulation conditions, the efficiency of HT loop and LT loop were 16.83% and 17.66%, respectively. The chosen working fluids were water for HT loop and R-245fa for LT loop.

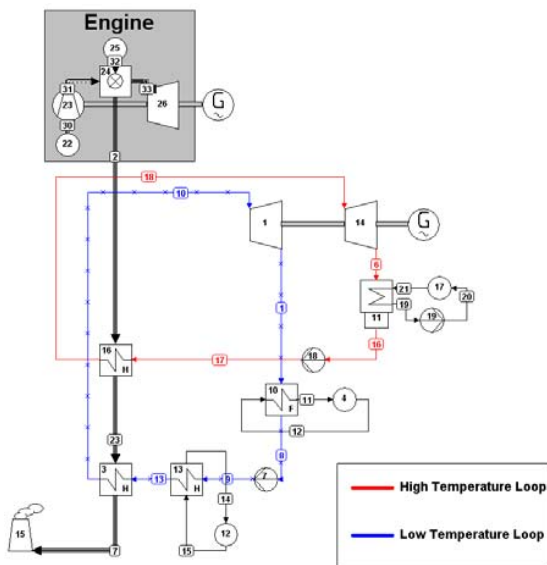

Fig.11 schematic of co-generation system used for simulation

TABLE III  
LTL & HTL RANKINE CYCLE INPUT PROPERTIES

System	FACTOR	Case1	Case2
LTL	Working Fluid	Ethanol	R245fa
	$T_{cond}$ [°C]	65.06	64.98
	$T_{max, c}$ [°C]	100	100
	$T_{max, e}$ [°C]	150	150
	$P_{cond}$ [bar]	0.59	5.3
	$P_{eva}$ [bar]	4.5	25
HTL	Working Fluid	water	
	$T_{cond}$ [°C]	133.53	
	$T_{max}$ [°C]	260	
	$P_{cond}$ [bar]	3	
	$P_{eva}$ [bar]	30	

$P_{eva}$ = Evaporation Pressure,  $P_{cond}$ = Condensation Pressure,  $T_{cond}$ = Condensation Temperature,  $T_{max, coolant}$ =Maximum Temperature, c= heat source is coolant, e= heat source is exhaust gas

### V. CONCLUSION

This study was designed to explore the cogeneration system efficiency for various working fluids and select the optimum working fluid. The principle conclusions of this study can be summarized as follows:

- 1) Water is favorable working fluid for HT loop because its latent heat of vaporization is high.
- 2) The temperature of the available heat sources for LT loop is low; hence, either ethanol or R-245fa is suitable working fluid rather than water. These working fluids hardly affect the maximum efficiency, but the optimum efficiency relies on boiler pressure and superheating temperature. Since the heat source temperature highly relies on driving conditions of vehicles, care must be taken on working fluid selection.
- 3) LT loop efficiency can be improved further with an additional heat source of exhaust as well as the coolant.
- 4) When the chosen working fluids were water for HT loop and R-245fa for LT loop, the possible efficiency of HT loop and LT loop were 16.83% and 17.66%, respectively.

### ACKNOWLEDGMENT

The authors acknowledge the financial support for this research project provided by Korean Ministry of Knowledge Economy. This work was done as a part of Industry sources development project.

This work was supported by the Second Stage of Brain Korea 21 Project in 2010.

### REFERENCES

- [1] Richard Stobart and Rohitha Weerasinghe, "Heat Recovery and Bottoming Cycles for SI and CI Engines – A Perspective", 2006-01-0662, 2006
- [2] T. Endo, S. Kawajiri, Y. Kojima, K. Takahashi, T. Bada, S. Ibaraki, T. Takahashi, M. Shinohara, "Study on Maximizing Exergy in Automotive Engines", SAE 2007-01-0257, 2007.
- [3] Ho Teng, Gerhard Regner, Chris Cowland, "Waste Heat Recovery of Heavy-Duty Diesel Engines by Organic Rankine Cycle Part I: Hybrid Energy System of Diesel and Rankine Engines", SAE 2007-01-0537, 2007.
- [4] Ho Teng, Gerhard Regner, Chris Cowland, "Waste Heat Recovery of Heavy-Duty Diesel Engines by Organic Rankine Cycle Part II: Working Fluids for WHR-ORC", SAE 2007-01-0543, 2007.
- [5] Sukjung Bae, Hyungseok Heo, Heonkyun Lee, Youngdae Choung, Jaesoon Hwang, Chunbeom Lee "An Investigation on Working Fluids for an Exhaust Waste Heat Recovery System of a Gasoline Engine", KSAE 09-A0027, 2009.
- [6] J. Ringler, M. Seifert, V. Guyotot, W. Hübner, "Rankine Cycle for Waste Heat Recovery of IC Engines", SAE 2009-01-0174, 2009.