

Optimization of Energy Conservation Potential for VAV Air Conditioning System using Fuzzy based Genetic Algorithm

R. Parameshwaran, R. Karunakaran, S. Iniyan, Anand A. Samuel

Abstract—The objective of this study is to present the test results of variable air volume (VAV) air conditioning system optimized by two objective genetic algorithm (GA). The objective functions are energy savings and thermal comfort. The optimal set points for fuzzy logic controller (FLC) are the supply air temperature (T_s), the supply duct static pressure (P_s), the chilled water temperature (T_w), and zone temperature (T_z) that is taken as the problem variables. Supply airflow rate and chilled water flow rate are considered to be the constraints. The optimal set point values are obtained from GA process and assigned into fuzzy logic controller (FLC) in order to conserve energy and maintain thermal comfort in real time VAV air conditioning system. A VAV air conditioning system with FLC installed in a software laboratory has been taken for the purpose of energy analysis. The total energy saving obtained in VAV GA optimization system with FLC compared with constant air volume (CAV) system is expected to achieve 31.5%. The optimal duct static pressure obtained through Genetic fuzzy methodology attributes to better air distribution by delivering the optimal quantity of supply air to the conditioned space. This combination enhanced the advantages of uniform air distribution, thermal comfort and improved energy savings potential.

Keywords—Energy savings, fuzzy logic, Genetic algorithm, Thermal Comfort

I. INTRODUCTION

THE Variable Air Volume (VAV) systems are a recent innovation in Heating Ventilation and Air Conditioning (HVAC) design. These are aimed at reducing building energy consumption while maintaining the primary role of air conditioning. The temperature of a space is maintained at the desired level by counteracting the cooling load with a certain volume flow rate of supply air at certain supply temperature. A small temperature difference requires lower compressor power and large volume flow rate requires more fan power. If the same load is met by low supply air volume flow rate at large temperature difference, then it will require less fan power and high compressor power. A low supply airflow rate leads to poor temperature distribution in the space. Hence, a certain combination of supply airflow rate and temperature is required so that the total power requirement will be minimal. In a Constant Air Volume (CAV) system, the volume airflow rate is kept constant at its maximum value and varying the supply air temperature to counteract the cooling load, which limits the scope of optimizing the CAV system. But in the case of VAV system, both the airflow rate and temperature of supply air can be changed, which gives scope for optimizing the fan power and compressor power. The performance of the

HVAC system can be improved through the optimization of the supervisory control strategy. The GA to maximize the overall operating efficiency can adjust the variable air volume HVAC system controller set points. Several researchers have contributed to the development of HVAC component optimization models and a few of them are reviewed. The concept of using simulation as a tool for performance validation and energy analysis of HVAC systems to develop significant potential for improving the monitoring and supervision of building systems in order to optimize operational performance was described by Tim Salsbury and Rick Diamond [1]. The model based prediction of air temperature using artificial neural network (ANN) technique with reduced prediction errors obtained by incorporating fuzzy logic methodology was well explained by Brian A. Smith [2].

A general and systematic methodology, termed complete simulation-based sequential quadratic programming for determining the optimal control of building HVAC systems was presented by Jian Sun and Agami Reddy [3]. Many design problems related to buildings involving capital and operating costs while providing acceptable service were explained by Caldas et al [4]. Genetic algorithm (GA) is an optimization method that has been applied to these problems. A new concept of integrating neural network and genetic algorithm in the system optimal control was discussed by Chow et al [5]. The paper that investigated the application of a multi-objective genetic algorithm (MOGA) search method to identification of the pay-off characteristic between the energy cost of a building and the occupant thermal discomfort was presented by Jonathan et al [6]. Optimization of building envelope design with respect to indoor environment and energy consumption can be done using the genetic optimization program "GenOpt" and the simulation program "Energy Plus" was elucidated by Johnny N.Holst et al [7]. The optimization yields 22% energy savings related to the actual design energy consumption. Genetic algorithm (GA) applied to solve optimal chiller loading (OCL) problem has been gaining its momentum. These studies use the part load ratios (PLR) of chiller units to binary code chromosomes, and execute reproduction, crossover and mutation operation and the method was well employed by Yung – Chung et al [8] in their paper. The use of weighted linguistic fuzzy rules in combination with a rule selection process to accurately develop a fuzzy logic controller dedicated to control the heating, ventilation and air conditioning (HVAC) systems energy performance and indoor comfort requirements was proposed by Rafael Alcala et al [9]. A genetic optimization process to perform the rule weight derivation and rule selection was developed. The concept of genetic algorithm to

optimize the selection of chiller size in a multi-chiller central plant for arbitrary cooling load profiles has been evaluated by Lu Lu and Wenjian Cai [10]. The fuzzy logic control of compressor speed in refrigeration for a cold store application was investigated by C. Aprea et al [11]. The application of genetic algorithm to optimize the model based VAV air conditioning system was described by S. Wang and X. Jin [12]. Several inherent features of fuzzy logic applied to industrial applications were demonstrated by Timothy J. Ross [13]. The building thermal analysis pertaining to theoretical and experimental modeling based on a fuzzy model represented by non-linear relations between input and output variables obtained by least-squares optimization has been explained by Igor Skrjanc [14]. In the present work, the optimal set points from GA were obtained to control the VAV air handling system for maintaining the indoor thermal comfort and energy savings.

II. SYSTEM DESCRIPTION

The Fig.1 shows a schematic diagram of VAV GA optimization system with FLC, which is considered in this study. The major components of the system are: (i) environmental zone (ii) supply and return variable speed fan and duct work (iii) a cooling and dehumidifying coil (iv) a pump and piping system (v) a chiller. The airflow rates to zone are controlled by the zone damper or by the fan speed control. The outdoor airflow rates are changed by positioning the fresh, exhaust and return air dampers. The temperature of supply air is controlled by several control actions, namely, varying damper position, varying the mass flow rate of chilled water flowing in the cooling coil and varying the temperature of the chilled water. The temperature sensor, air velocity sensor, RH sensor and static pressure senses the actual value and gives the corresponding output in voltage range. It is then fed to the interfacing unit with PCI card. The analog signal is converted into digital signal. The digital signal is then given to the computer where the set points are optimized by genetic algorithm and assigned to fuzzy logic controller program. The control inputs can be simultaneously changed in variable cooling loads acting on the zones.

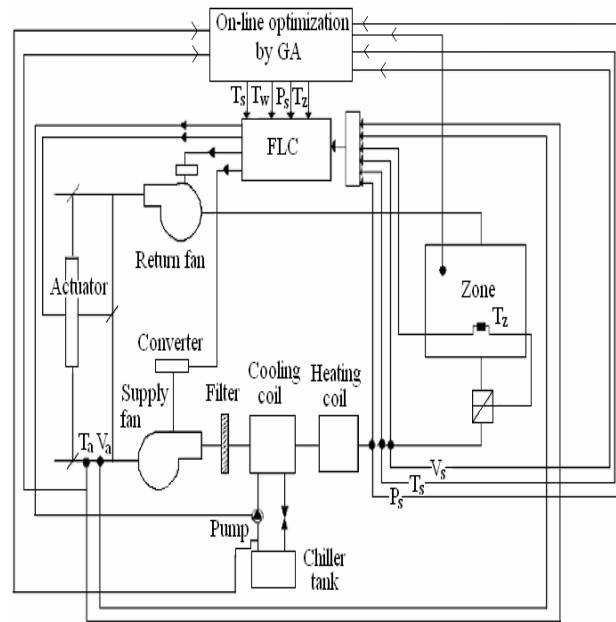

Fig. 1 schematic diagram of a VAV system

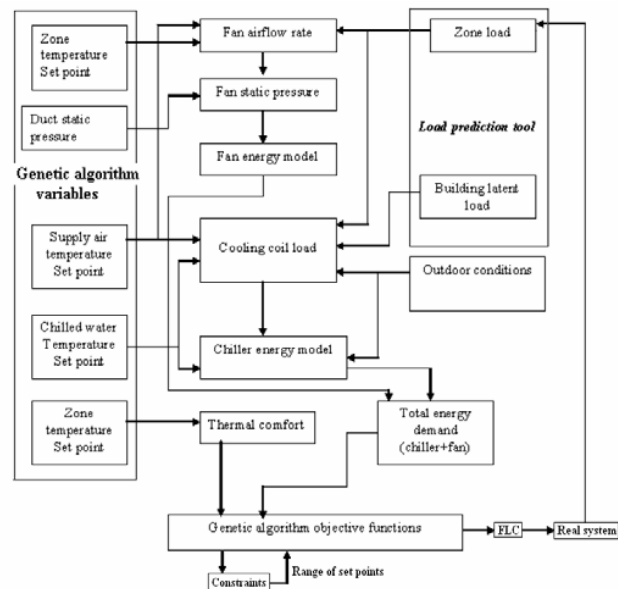

Fig. 2 flow diagram for VAV system performance optimization

III. FORMULATION OF OPTIMIZATION MODEL FOR VAV SYSTEM

The VAV air conditioning loads vary with both occupancy and weather condition. The efficiency of all the energy consuming components should be known for all possible set points. The major energy consuming components of the system are described below.

A. Fan

The main advantage of a VAV system is obtaining energy saving by reducing fan speed. Fan provides quantity of

TABLE I
TRANSDUCERS SPECIFICATIONS

Transducers	Range	Accuracy
Velocity sensor (m/s)	0.15-10	±0.05
Static pressure sensor (bar)	0-1	±0.1
Relative humidity sensor (%)	0-100	±0.03
Temperature sensor with signal conditioner (°C)	0-100	±0.5

The outputs are the temperature of the zone, temperature of the chilled water, supply airflow rate, static pressure in the duct system and fan speed. The transducer specifications are mentioned in the Table I.

primary supply air required by the system. The change in the characteristic of the fan is accomplished through the use of a variable speed drive. The fan energy consumption (W_f) is calculated as a function of the fan airflow rate (Q_f) and total static pressure. The total static pressure is equal to the summation of static pressure set point (P_s) and the remaining static pressure drop, which is a function of the airflow rate. Fan energy consumption is calculated as follows

$$W_f = Q_f (P_s + 2 \cdot 10^{-6} Q_f^2) / 680000 \quad (1)$$

where

$$Q_f = \sum Q_z = \sum q_s / [1.2(T_z - T_s)] \quad (2)$$

B. Chiller

Chiller is the major component which needs attention while minimizing the energy consumption of the system. The task of the chiller is to extract heat from the air in the chilling system. The chilled water acts as an intermediary. The efficiency of the chiller is defined as the ratio of heat extracted from air to the power used by the compressor in the chiller. The chiller energy consumption is given by the following expression,

$$W_c = (\lambda Q_f (H_0 - H_s) + q_t \cdot (1 - \lambda)) / COP \quad (3)$$

λ is the outdoor air fraction in the supply air and is determined using the standard economized logic.

If $H_o \geq ((q_t/Q_f) + H_s)$ then $\lambda = 0.2$ else $\lambda = 1$

If $H_o \leq H_s$ then $W_c = 0$

The coefficient of chiller performance (COP) is determined by,

$$COP = 7.9275 PLR^3 - 21.194 PLR^2 + 16.485 PLR + 2.2139 + 0.1 (Tw-6) \quad (4)$$

The water flow rate, which is used in the constraint, could be determined by,

$$Q_w = Q_{w_{rate}} \{ (W_c \cdot COP \cdot (T_s - T_w) / (h_{w_{rate}}) \}^{1.25} \quad (5)$$

The total energy consumption is calculated as,

$$W_t = W_f + W_c \quad (6)$$

Objective function

The objective function to minimize total energy consumption (W_t) and to minimize thermal comfort related problems (T_{cp}) are given by,

$$\begin{aligned} \text{Min } (W_t) &= f(T_s, T_z, P_s, T_w) \\ \text{Min } (T_{cp}) &= f(T_s, P_s, T_z) \end{aligned} \quad (7)$$

Problem Variables

$$13^\circ \text{C} \leq T_s \leq 18^\circ \text{C}, \quad 23^\circ \text{C} \leq T_z \leq 25^\circ \text{C} \\ 6^\circ \text{C} \leq T_w \leq 11^\circ \text{C}, \quad 360 \text{ Pa} \leq P_s \leq 640 \text{ Pa}$$

Constraints

$$297 \text{ cmm} \leq Q_{f \text{ design}} \leq 495 \text{ cmm}$$

$$Q_w \leq 6.9 \text{ l/s}$$

In Fig.2, the VAV model determines the energy consumption and thermal comfort resulting from the change in outdoor conditions, indoor loads (independent variables) and controller set points (dependent variables or problem variables). The independent variables are (i) the enthalpy of outdoor air (H_o), (ii) the indoor sensible load (q_s), and (iii) the total load of the building (q_t). However, the dependent variables or problem variables are (i) the zone temperature (T_z), (ii) the supply duct static pressure (P_s), (iii) the supply air temperature (T_s), and (iv) the chilled water temperature (T_w).

IV. FUZZY LOGIC CONTROLLER DESIGN

The fuzzyTECH MCU-96 Edition was used to design the fuzzy logic controller. It is a full graphical tool that supports all design steps for fuzzy system engineering: structure design, linguistic variables and rules definition. It provides M code, which can be used for system representation in simulation and mathematical software packages. Fuzzy set is characterized by a membership function whose value ranges from 0 to 1. Fuzzy logic controller consists of three steps of problem solving procedure.

A. Fuzzification

It consists of the input variables in the form of membership functions, here in this work the input variables are considered to be temperature in terms of error in temperature and change in error and duct static pressure.

B. Linguistic descriptions

Based upon the input variables, human knowledge based rule is developed with respect to the required output. In this case the input variables are temperature and static pressure and the output variable is fan speed in rpm.

C. Defuzzification

It consists of the output variable in the form of membership function. In this case the output variable is fan speed in rpm. The input and output membership functions for FLC are shown in Fig.3. to Fig.6. The input membership functions are defined taking into account the temperature error, temperature error variation and duct static pressure. The Fan speed variation in rpm is the output membership function. Triangular membership functions were employed for simplified calculations for the inputs and the output.

In the building zone, when the system is at full load the temperature is maintained to be 24°C . Corresponding static pressure is sensed and given to the fuzzy logic controller. The fuzzy logic controller manipulates the input variables in corresponding to the membership functions and depends upon

the human based logic. The fan speed is calculated to be very high (VH) and the corresponding fan speed is taken in to account, under part load conditions. The air velocity in the zone decreases correspondingly there is decrease in static pressure in the duct. The fuzzy logic controller senses this input through the temperature and pressure sensor and gives the corresponding reduced fan speed in rpm. By decreasing

the fan speed the energy is conserved in the system and by maintaining the temperature and Air distribution in the zone the thermal comfort is achieved in the system, under part load

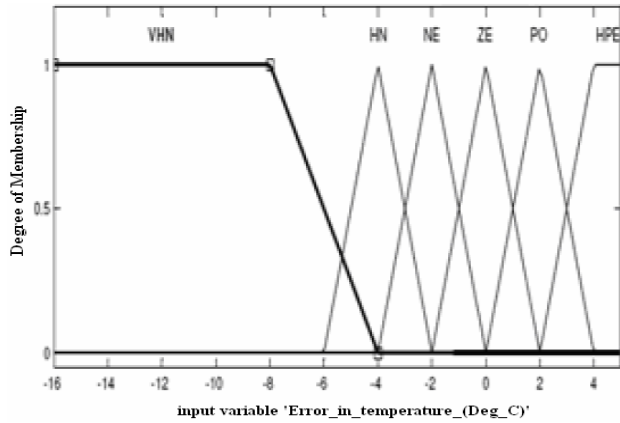

Fig. 3 error in temperature in deg C

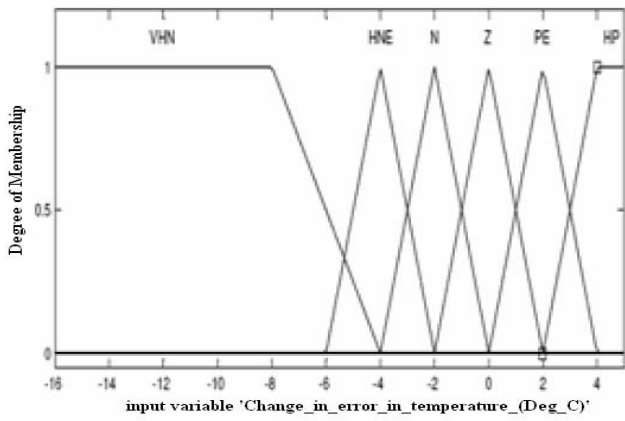

Fig. 4 change in error in temperature in deg C

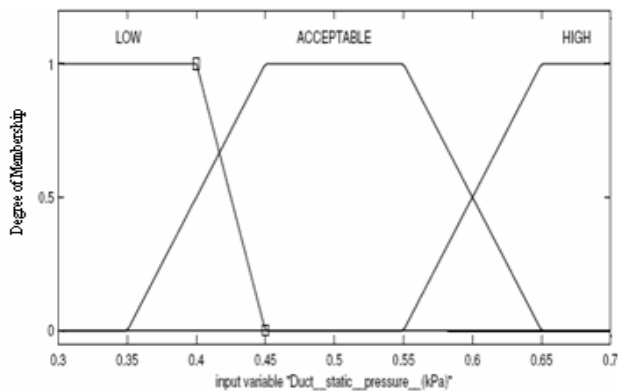

Fig. 5 static pressure range in kPa

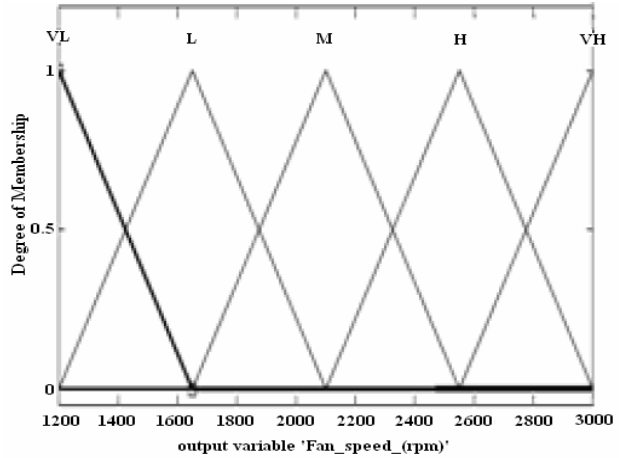

Fig. 6 fan speed variation in rpm

conditions. Similarly, Fuzzy logic controller was designed for controlling chiller water temperature and supply air temperature. Input membership functions for FLC are chiller water temperature and supply air temperature and output membership function is compressor speed.

V. EXPERIMENTATION

A single zone VAV Air conditioning software laboratory building situated in a hot and humid climate at Anna University, Chennai, India is considered for the validation. The building zone is decided to be 33 m × 8.5 m × 2.9 m of dimensions.

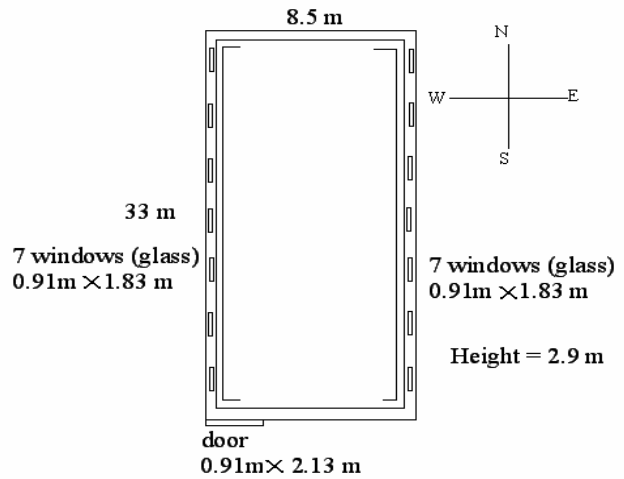

Fig. 7 block diagram of the building model

The building has seven windows at each side and door with dimensions 0.91 m × 1.83 m and 0.91 m × 2.13 m as shown in Fig.7. Cooling load calculations have been carried out for solving the heat load in the model. The construction materials and properties are selected according to ASHRAE handbook.

The zone has 45 computers on each side and total occupancy of 95 people and lightning load was taken as per the ASHRAE Standards. The building has twenty pairs of supply and return diffusers arranged in four columns. From the cooling load calculation it is found that the system required 30 TR chiller units, which is connected with air handling unit. The supply fan supplies the maximum of 460 cmm into the zone with the duct static pressure of 0.63 k Pa.

To verify the numerical results, experiments were conducted on a scale model as per the ASHRAE standards. The photographic view of the experimental setup is shown in Fig.8. Due to the symmetry of the room, only a portion was considered for the analysis. This model is geometrically similar to full scale in all details that are important for the volume flow, the energy flow and the contaminant flow. The scale model (1.48 m × 1.75 m × 0.6 m) for the building and Air handling system with FLC unit have been constructed in the Refrigeration and Air conditioning Laboratory at Anna University, Chennai, India. The experimental setup was fully insulated to avoid infiltration of air.



Fig. 8 photographic view of experimental

set up. As per simulation load pattern, the heat load (sensible heat) variation was carried out by electrical load and Latent heat variation was also carried out by steam flow control in the building zone. The sensors sense the actual value and signals are given to the DAC where the analog signal from the interfacing unit will be of (0-5V) then it is amplified to (0-230V) AC, which is again converted into 0-230V DC. The DC voltage is feed back to the thyristor driven variable speed drive and the varied voltage correspondingly varies the fan speed, which is incorporated with the load. The system is set to run throughout the day i.e. 24 hours and the corresponding temperature, air velocity and RH are stored in a data logger.

V. RESULT AND DISCUSSION

A genetic algorithm optimization program was developed for solving the VAV Air conditioning optimization problem. A design day approach was taken in which the results are typically presented on a daily basis, showing optimal operation of the VAV system. Optimal operation is defined as the operation in which all processes of the VAV system are optimized. The sensible and latent load acting on zone was chosen. The occupancy load profile is depicted in Fig.9. The temperature profile corresponding to a design day with

maximum and minimum outdoor air temperature is shown in Fig.10. The solution to the optimization problem subject to daily loads can be stated as the minimization problem. For GA optimization, best parameters were taken as

Crossover probability (P_c) = 0.9
 Mutation probability (P_m) = 0.04
 No. of population (N_p) = 20
 Fraction of outdoor air (λ) = 0.2
 Total string length = 27

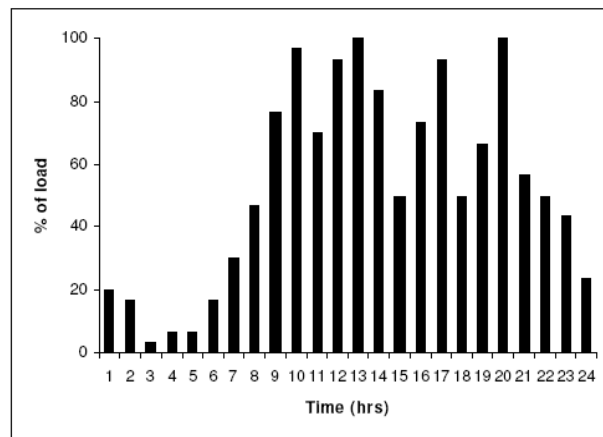

Fig. 9 occupancy load Variation in%

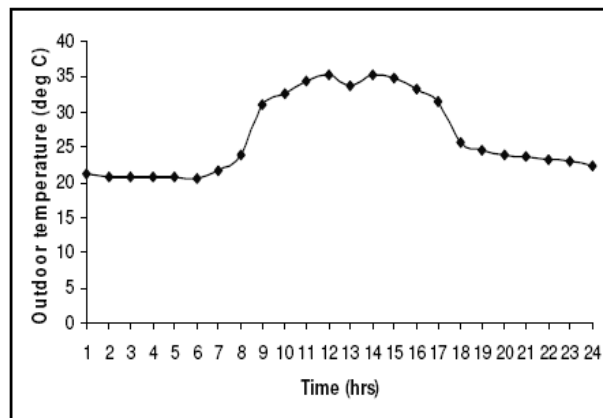

Fig. 10 variation of outdoor temperature

For the genetic algorithm optimization, problem variables were taken as supply duct static pressure (P_s) which varies from 360 to 640 Pa. Supply air temperature (T_s), chilled water temperature (T_w) and zone temperature (T_z) varies from 13 to 18 °C, 6 to 11°C and 23 to 25 °C respectively.

The CAV & VAV analysis and VAV GA optimization with FLC were carried out and the results are projected. Energy consumption between CAV, VAV and optimized system and energy savings were discussed. The supply air temperature, supply airflow rate, fan power and compressor power were found with respect to time. The supply air temperature variation in the case of CAV, VAV and VAV GA optimization with FLC is represented in Fig.11. The supply air

temperature was maintained constant to the level of 15 °C in VAV system. But in the case of CAV and GA optimization it

as shown in Fig.12. After GA optimization the supply airflow rate was reduced to an extent of 7.6% in comparing with VAV

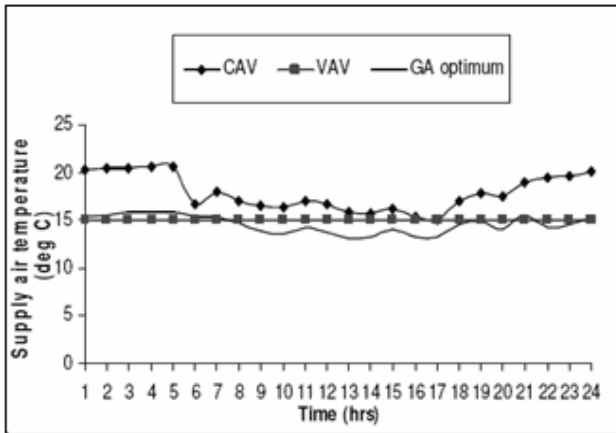

Fig. 11 variation of supply air temperature

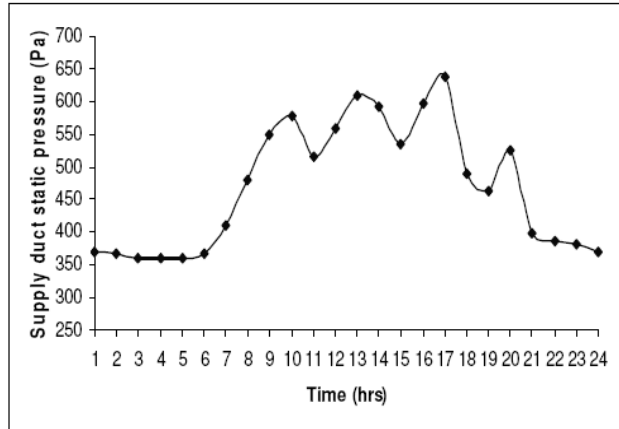

Fig. 14 variation of supply duct static pressure

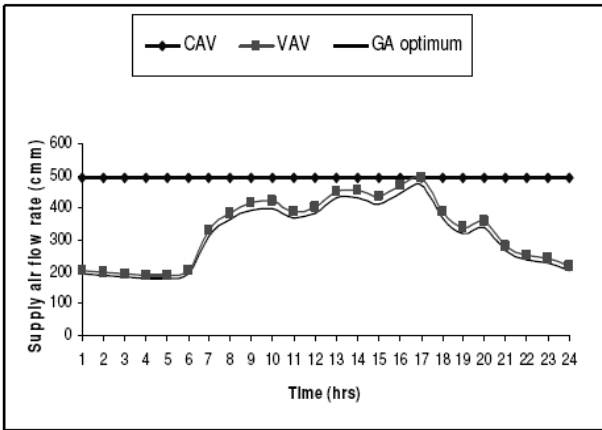

Fig. 12 variation of supply air flow rate

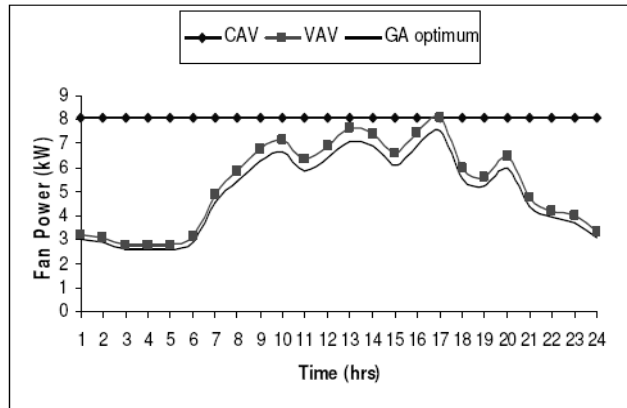

Fig. 15 variation of fan power with time

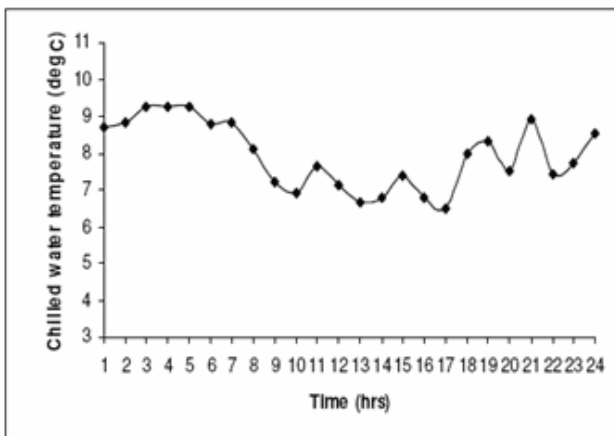

Fig. 13 variation of chilled water temperature

was obtained in the range of 15 °C to 20 °C and 13 °C to 18 °C respectively. In the case of supply airflow rate variation, CAV was maintained constant to an extent of 495 cmm, where as in VAV system it was found to vary from 200 cmm to 495 cmm

system. Variation of optimal chilled water temperature with respect to time is shown in Fig.13. After GA optimization, the graphs were depicted. The temperature variation was maintained in between 7 °C to 10 °C. A better air distribution criterion in the proposed VAV air conditioning system is solved by the duct static pressure, which is maintained in particular designed level. After optimization, GA carried out the optimal supply duct static pressure with respect to load. In VAV GA optimization with FLC, the optimal duct static pressure that was maintained at the time of full and part load conditions was 640 Pa and 360 Pa respectively is shown in Fig. 14. Fan power consumption was constant as 8 kW for all loads in CAV system. But in case of VAV and VAV GA optimization system, fan power consumption and supply airflow rate also decreases with respect to load variation. Hence, the fan power consumption was varied from 8 kW to 3 kW and 7.5 kW to 2.7 kW respectively at the time of peak load and part load conditions is shown in Fig.15. It is found that for a VAV GA optimization system, the fan power consumption is 44.5% and 12.5% less than the CAV and VAV system respectively. The variation of compressor power of the CAV, VAV and VAV GA optimization system is shown in the fig.16. The systems registered a variation in power consumption with time. The change in load requires a varying quantity of refrigerant to be

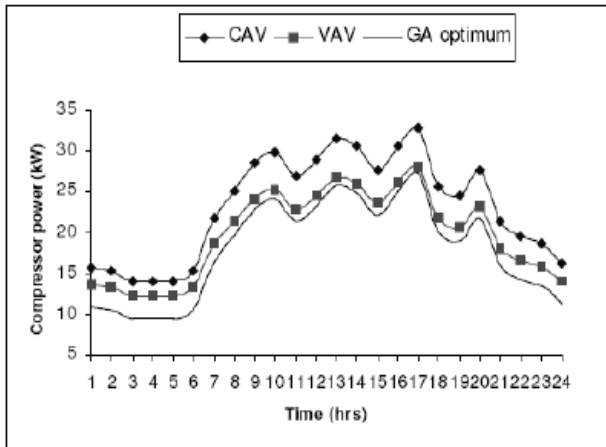

Fig. 16 variation of compressor power with time

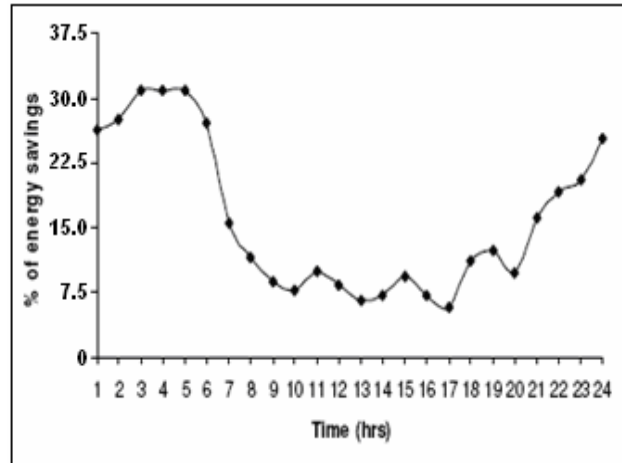

Fig. 18 variation of % of energy savings with time

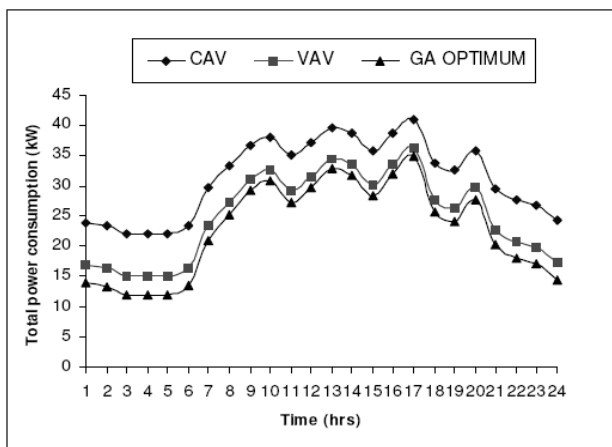

Fig.17 variation of total power consumption with time

circulated in the refrigeration circuit; hence the power consumption of the compressor varies. It is observed that VAV GA optimization system compressor power saving was compared with CAV and VAV system is 28% and 9.5% respectively. As the load increases, the supply air and chilled water temperatures decrease. At peak load, the supply air temperature was found to be 13.2 °C and the corresponding chilled water temperature was about 6.5 °C to maintain the zone temperature set point limited at 23°C. Another advantage was that reduction of energy use while maintaining building thermal comfort. When the load distribution on zone changes significantly, the individual determination of optimal zone temperature set points according to proper loads decrease energy usage. Total power consumption was found out for the CAV, VAV and VAV GA optimal system with FLC shown in Fig.17. By comparing other systems, power consumption reduces significantly when the system was optimized. In VAV GA optimal system with FLC, percentage of energy savings potential is expected to achieve 31.5% as shown in Fig.18.

IV. CONCLUSION

One of the major objectives of installing GA optimal set points to fuzzy logic control systems in buildings is to improve the energy efficiency of heating, ventilation and air-conditioning (HVAC) systems. Incorporating several optimizing functions in GA optimization and performing real adjustment processes were carried out. The problem of optimizing the thermal processes in a VAV Air conditioning system was explored. Steady-state models were developed and constrained optimal control problem was formulated and solved. The proposed GA optimization process was applied to an existing HVAC system, installed in Anna University. The set points, such as the zone air temperature, the supply duct static pressure, the supply air temperature were optimized for VAV system. Control inputs were given to FLC controller for tuning the optimized values in real system. The genetic algorithm optimization showed the reduction in power consumption of fan and compressor that were obtained by maintaining the zone temperature at 23°C precisely. In this case, the optimization using genetic algorithm was done for a design thermal load. From the energy analysis, it was observed that the change in load conditions led to varied air flow rates that demand different energy requirements in the AHU and cooling coil. The result strongly suggest that for the present VAV GA optimal system equipped with FLC, the total energy savings compared with CAV A/C system was 31.5%. The VAV GA optimal system with FLC delivers an optimum quantity of air to the conditioned space to avoid the air distribution problem. Hence, correct selection of objective function with constraint for VAV systems with FLC can provide a better thermal comfort and high energy saving potential with GA optimal controllers' set points.

ACKNOWLEDGMENT

The author would like to thank the CPDE, Anna University for funding and excellent support provided to this research project. Special thanks go to Dr. D. Mohan Lal, Anna University.

NOMENCLATURE

P _c	- Crossover Probability
P _m	- Mutation Probability
F (S)	- Fitness function
H _o	. Enthalpy of outdoor air, kJ/Kg
q _s	. Indoor sensible load, kW
q _t	. Total load of the building, kW
T _s	. Supply air temperature, °C
T _z	. Zone temperature, °C
T _w	. Chilled water temperature, °C
P _s	. Static pressure, Pa
Q _z	. Zone airflow rate, l/s
Q _f	. Fan airflow rate, l/s
Q _c	. Chilled water flow rate, l/s
cmm	-Cubic meter per minute
CFM	- Cubic feet per minute
PLR	- Part load ratio

Authors' biographies:

R. Parameshwaran is a Post Graduate Research Scholar with the Refrigeration and Air Conditioning Division, Department of Mechanical Engineering, Anna University, Chennai-600025, India (e-mail: parameshwins@rediffmail.com).

R. Karunakaran is a Visiting Faculty with the Refrigeration and Air Conditioning Division, Department of Mechanical Engineering, Anna University, Chennai - 600 025, India (corresponding author; e-mail: karuna30722@yahoo.com).

S. Iniyar is an Assistant Professor with the Refrigeration and Air Conditioning Division, Department of Mechanical Engineering, Anna University, Chennai-600025, India.

Anand A. Samuel is a Professor, Department of Mechanical Engineering, Vellore Institute of Technology, Deemed University, Vellore, India.

REFERENCES

- [1] Tim Salsbury, Rick Diamond, "Performance validation and energy analysis of HVAC systems using simulation", *Energy and Buildings*, vol. 32, pp. 5 – 17, 2000.
- [2] Brian A. Smith, Ronald W. McClendon, Gerrit Hoogenboom, "Improving Air Temperature Prediction with Artificial Neural Networks", *International Journal of Computational Intelligence*, vol. 3, pp. 179 – 186, 2006.
- [3] Jian Sun and Agami Reddy, "Optimal control of building HVAC&R systems using complete simulation-based sequential quadratic programming (CSB-SQP)", *Building and Environment*, vol. 40, pp. 657 – 669, 2005.
- [4] L. G. Caldas, L. K. Norford, "Genetic algorithms for optimization of building envelopes and the design and control of HVAC systems", *Journal of solar energy engineering, Transactions of the ASME*, 2003.
- [5] T. T. Chow, Z. Lin and C. L. Song, G. Q. Zhang, "Applying neural network and genetic algorithm in chiller system optimization", *Seventh International IBPSA Conference*, Brazil, 2001.
- [6] Jonathan A. Wright, A. Heather, Loosemore, Raziye Farmani. "Optimization of building thermal design and control by multi-criterion genetic algorithm", *Energy and Buildings*, 34, pp. 959 – 972, 2002.
- [7] Johnny N.Holst, "Using whole building simulation models and optimizing procedures to optimize building envelope design with respect to energy consumption and indoor environment", *Eighth International Conference*, 2003.
- [8] Yung-Chung Chang, Jui-Kun Lin, Meng-Hsuan Chuang, "Optimal chiller loading by genetic algorithm for reducing energy consumption", *Energy and Buildings*, vol. 37, pp.147 – 155, 2005.
- [9] Rafael Alcala, Antonio Gonzalez, Francisco Herrera, Jorge Casillas, Oscar Cordon, "A genetic rule weighting and selection process for fuzzy control of heating, ventilation and air conditioning systems", *Engineering Applications of Artificial Intelligence*, vol. 18, 279 – 296, 2005.
- [10] Lu Lu and Wenjian Cai, "Application of genetic algorithms for optimal chiller selection in HVCA systems", *13th Int.Conference on Process Control*, 2001.
- [11] C. Aprea, C. Renno, R. Mastrullo, "Fuzzy control of the compressor speed in a refrigeration plant", *International Journal of Refrigeration*, vol. 27, pp. 639 – 648, 2004.
- [12] S. Wang, X. Jin, "Model-based optimal control of VAV air-conditioning system using genetic algorithm", *Building and Environment*, vol. 35, pp. 471 – 487, 2000.
- [13] Timothy J.Ross (1995.), *Fuzzy logic with engineering applications*, Mc Graw Hill, Inc.
- [14] Igor Skrjanc, Borut Zupancic, Bostjan Furlan and Alas Krainer, "Theoretical and experimental fuzzy modeling of building thermal dynamic response", *Building and Environment*, vol. 36, 1023-1038, 2001.