

Investigating the Effectiveness of a 3D Printed Composite Mold

Peng Hao Wang, Garam Kim, Ronald Sterkenburg

Abstract—In composite manufacturing, the fabrication of tooling and tooling maintenance contributes to a large portion of the total cost. However, as the applications of composite materials continue to increase, there is also a growing demand for more tooling. The demand for more tooling places heavy emphasis on the industry's ability to fabricate high quality tools while maintaining the tool's cost effectiveness. One of the popular techniques of tool fabrication currently being developed utilizes additive manufacturing technology known as 3D printing. The popularity of 3D printing is due to 3D printing's ability to maintain low material waste, low cost, and quick fabrication time. In this study, a team of Purdue University School of Aviation and Transportation Technology (SATT) faculty and students investigated the effectiveness of a 3D printed composite mold. A steel valve cover from an aircraft reciprocating engine was modeled utilizing 3D scanning and computer-aided design (CAD) to create a 3D printed composite mold. The mold was used to fabricate carbon fiber versions of the aircraft reciprocating engine valve cover. The carbon fiber valve covers were evaluated for dimensional accuracy and quality while the 3D printed composite mold was evaluated for durability and dimensional stability. The data collected from this study provided valuable information in the understanding of 3D printed composite molds, potential improvements for the molds, and considerations for future tooling design.

Keywords—Additive manufacturing, carbon fiber, composite tooling, molds.

I. INTRODUCTION

THE continuous advancements and research going into composite material technologies coupled with composite material's outstanding capabilities over traditional aerospace alloys led to the rapid increase in popularity of composite materials in the aerospace industry [1]. However, as the aerospace industry's demand for composite component increases, so does the demand for more tooling. The demand for more tooling places heavy emphasis on the industry's ability to fabricate and maintain high quality tools while maintaining the tool's cost effectiveness. Tooling and molds represent a large portion of the entire production chain of composite components. Therefore, the tooling and mold's quality, cost and lead times severely affect the cost of production, especially in large volume productions [2]. Traditionally, the most popular tooling materials are metals such as aluminum and steel. These metal tools were fabricated using conventional metal fabrication techniques that can be time consuming and expensive to accomplish [3]. In order to

overcome traditional metal tooling's cost and fabrication time requirements, one of the alternative techniques of tool fabrication currently being developed that has garnered substantial attention in the aerospace industry utilizes additive manufacturing technology commonly known as 3D printing. The popularity of 3D printing is due to its advantages over traditional manufacturing. 3D printing has the ability to print an entire tool or mold in a single piece instead of attaching separate components together which helps contribute to a large reduction of the tooling cost [4].

In order to investigate the effectiveness of a 3D printed composite mold, the study utilized a steel valve cover from an aircraft reciprocating engine. A steel valve cover from an aircraft reciprocating engine was modeled employing reverse engineering techniques where a 3D visual model from the steel valve cover was generated to create an actual 3D printed composite mold [5]. The 3D printed composite mold was used to fabricate dimensionally identical carbon fiber versions of the steel aircraft reciprocating engine valve cover. The carbon fiber valve covers were evaluated for dimensional accuracy and quality while the 3D printed composite mold was evaluated for performance, durability, and also dimensional stability.

II. METHODOLOGY

The aircraft component used for this study was a steel valve cover from an aircraft reciprocating engine. 3D scanning was utilized in order to create a composite mold for fabricating the valve cover in carbon fiber. A FARO arm 3D scanner was used for scanning the steel valve cover as shown in Fig. 1. The steel valve cover's 3D scan data were processed for noise reduction, smoothing, and missing data was filled in. A surface was then generated using CATIA by processed mesh as shown in Fig. 2.

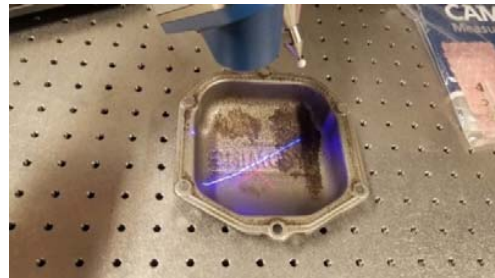

Fig. 1 3D scanning aircraft steel valve cover

Peng Hao Wang, Garam Kim, and Ronald Sterkenburg are with the School of Aviation and Transportation Technology, Purdue University, West Lafayette, IN 47907 USA (e-mail: pwang@purdue.edu, kim1652@purdue.edu, sterkenr@purdue.edu).

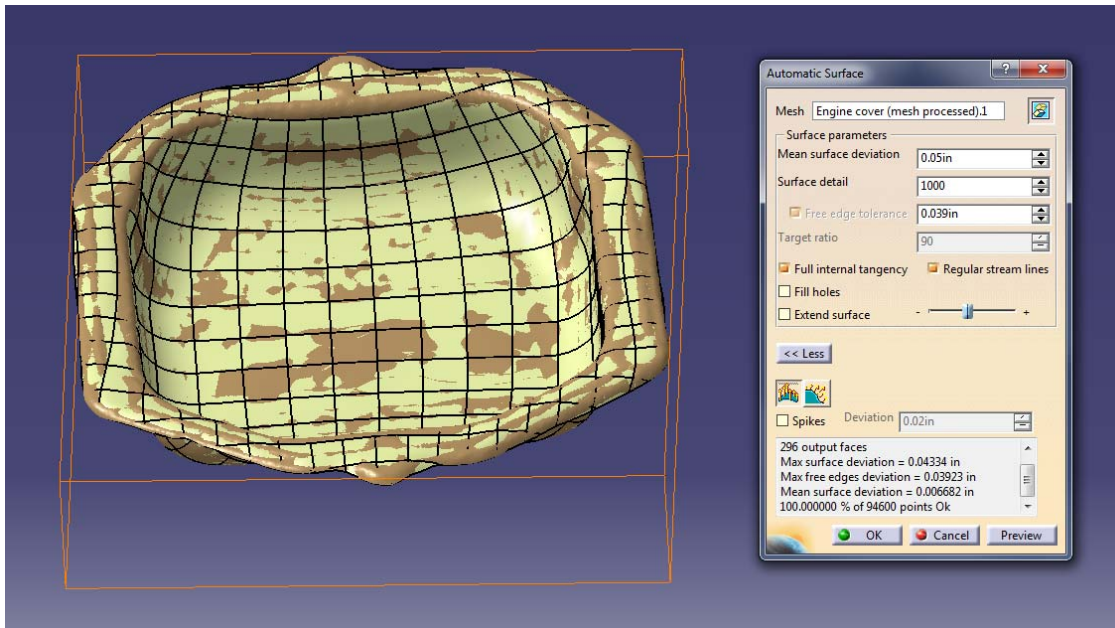

Fig. 2 Surface generation using CATIA

Using the generated surface, features were added to the surface to design the 3D printed composite mold. Fig. 3 shows the design of the 3D printed composite mold using CATIA.

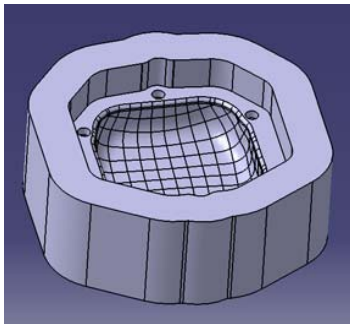

Fig. 3 Design of 3D printed mold

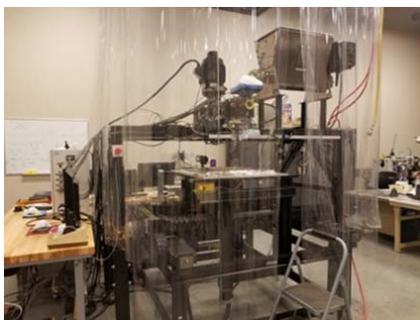

Fig. 4 CAMRI machine used for 3D printing

3D printing of the mold was accomplished by the Composite Additive Manufacturing Research Instrument (CAMRI) in Purdue University's Composites Manufacturing and Simulation Center (CMSC) as shown in Fig. 4. The mold

was printed using polyphenylene sulfide (PPS) and 50% carbon fiber by weight through a 4.0 mm nozzle in 6.15 mm wide 1.5 mm thick beads. Fig. 5 shows the slicing of the 3D printed composite mold. Total printing time for the 3D printed composite mold was 53 minutes and the total material used for the mold was 3480.82 g. The completed 3D printed composite mold was annealed in the oven at 120°C for a total of 4 hours then placed in a CNC for final machining.

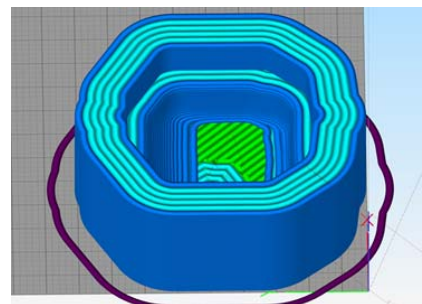

Fig. 5 Slicing of the 3D printed mold

The completed 3D printed composite mold was sealed using a mold sealer before semi-permanent mold release was applied onto the mold surface. In addition, single pull mold release was also applied to the mold before every part layup. Once the mold was properly prepared and the mold release had ample time to dry, four plies of carbon fiber were used for the fabrication of the main sections of the carbon fiber valve covers. Two additional plies were added to the flange area of the carbon fiber valve covers to improve the carbon fiber valve covers' durability as shown in Fig. 6. Finally, the layup and mold was vacuum bagged using an envelope bag and the carbon fiber valve covers were cured using an autoclave.

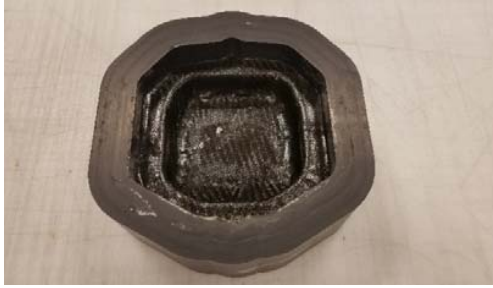

Fig. 6 Carbon fiber valve cover layout

After curing in the autoclave, the carbon fiber valve covers were post processed. Each carbon fiber valve cover was sanded and finished to the dimensions of the original steel valve cover and the mounting holes of the valve covers were also drilled to match the original steel valve cover. Fig. 7 shows a completed carbon fiber valve cover after post processing.



Fig. 7 Completed carbon fiber valve cover

III. RESULTS

A total of six carbon fiber valve covers were fabricated using the 3D printed composite mold. Dimensionally, the six carbon fiber valve covers were very consistent and all the carbon fiber valve covers mounted onto the aircraft reciprocating engine with no issues. The inconsistencies on the carbon fiber valve covers were mainly defects caused by the damages the 3D printed composite mold sustained after every part demolding process; although most of the defects on the carbon fiber valve covers as shown in Figs. 8 and 9 were cosmetic defects that can be easily remedied with some light post processing such as sanding and applying layers of clear coat. The condition of the 3D printed composite mold will continue to deteriorate as the fabricated part count increases. As a result of the deteriorating 3D printed composite mold, the quality of the carbon fiber valve covers will also continue to worsen.

In terms of the mold's performance, the 3D printed composite mold performed as expected and was used to successfully fabricate all six of the carbon fiber valve covers. All carbon fiber valve covers were cured and demolded from the 3D printed composite mold with no issues. However, durability wise, the 3D printed composite mold sustained increasing amounts of defect after every part demolding. The

main defects the 3D printed composite mold had were chipping of the mold surface and some cracking on the mold surface between the bead interfaces as shown in Figs. 10 and 11 respectively.



Fig. 8 Surface defects caused by mold surface chipping



Fig. 9 Surface defects caused by mold surface cracking



Fig. 10 Mold surface chipping



Fig. 11 Mold surface cracking between beads

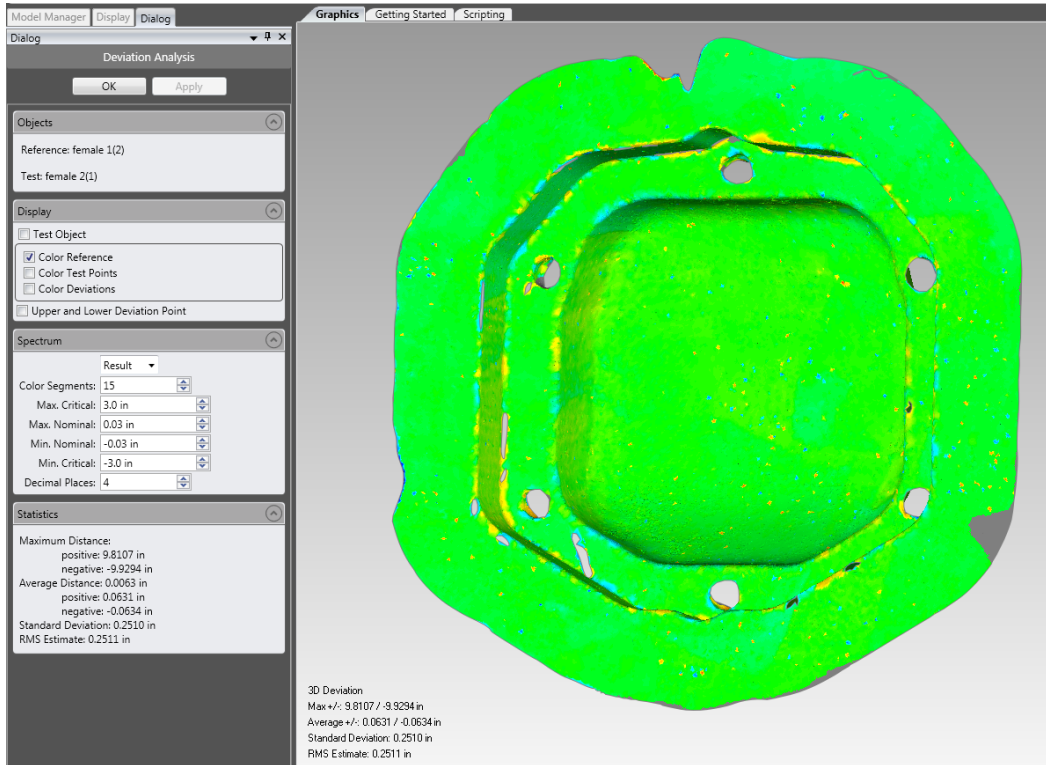

Fig. 12 Dimensional stability evaluation after one part

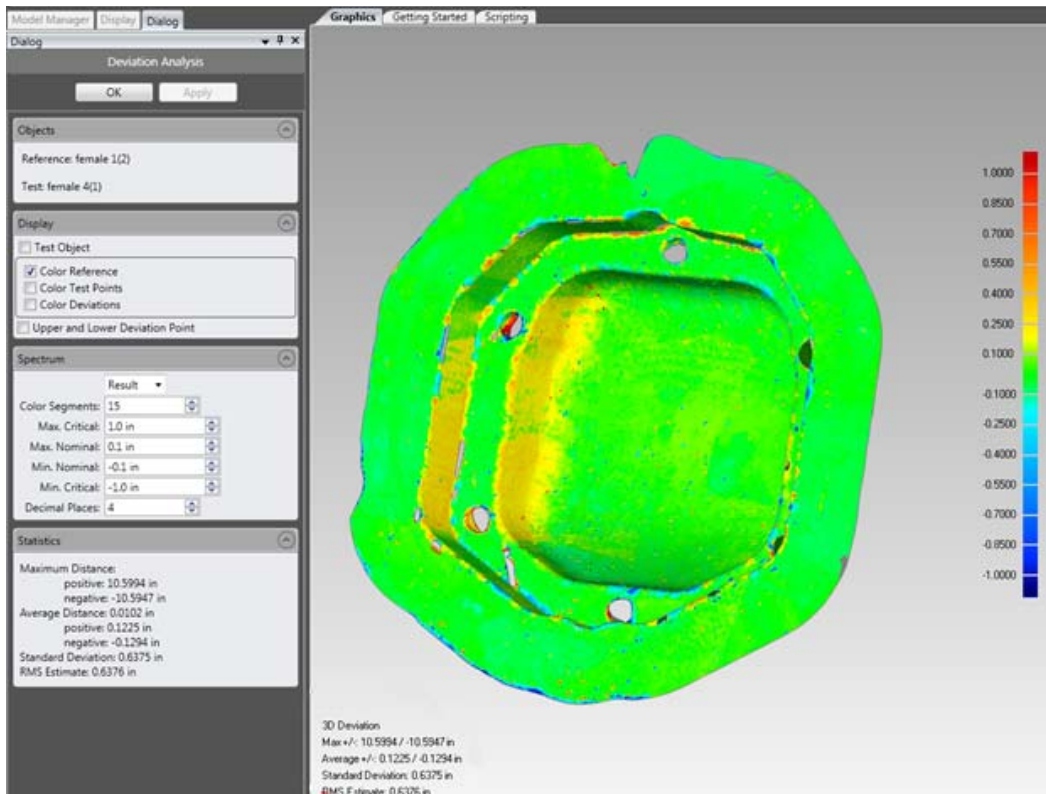

Fig. 13 Dimensional stability evaluation after six parts

The last evaluation of this study was on the dimensional stability of the 3D printed composite mold. The 3D printed composite mold was evaluated by 3D scanning the mold after the demolding process of each carbon fiber valve cover fabricated. The results of the 3D scans were used to determine the dimensional stability of the 3D printed composite mold. Fig. 12 shows the dimensional stability evaluation of the mold after fabricating one carbon fiber valve cover. Fig. 13 shows the dimensional stability evaluation after the mold has completed the sixth and last carbon fiber valve cover. From the evaluation results, there was no significant change in the mold geometry except for one specific section of the mold which experienced some minor deviation with many noise and missing data in the 3D scan results.

IV. CONCLUSION

Based on the results from this study, the team was able to investigate the effectiveness of a 3D printed composite mold by producing six identical carbon fiber valve covers from a single 3D printed composite mold. The six carbon fiber valve covers were all test fitted onto the original aircraft reciprocating engine and all six carbon fiber valve covers fitted perfectly with no issues as shown in Fig. 14. The six carbon fiber valve covers however did have various surface defects that were caused by the mold surface gradually deteriorating from each part production, raising durability concerns for the 3D printed composite mold. There can be an abundance of factors that may have caused the deterioration of the mold surface. Some examples of these factors include porosity within the 3D printed composite mold, the 3D printing tool path of the 3D printed composite mold, and weak interfaces between printed beads of the 3D printed composite mold [1]. Many of these factors can essentially be removed by changes to the design and fabrication technique of the 3D printed composite mold. For example, the issue of porosity within the 3D printed composite mold can be rectified by heat treatments to the mold or by the application of surface coatings. Advance approaches forming molds with varying material composition also known as gradient materials may also be a suitable solution [6]. Other factors such as the printing tool path and weak interfaces between the printed beads may be solved by performing further tool-path optimization for the printing process of the 3D printed composite mold [7].

Finally, the result of the study was able to identify that there was no significant change in the 3D printed composite mold's geometry except for one section on the 3D printed composite mold showing minor deviation in the 3D scan data. The minor deviation in mold geometry may be caused by the tool path used for the 3D printing or thermal and other types of localized stresses within the 3D printed composite mold [8]. Therefore, in order to fully understand the cause of the geometry deviation, further evaluations of the 3D printed composite mold may be required.



Fig. 14 Test fitting of carbon fiber valve cover

REFERENCES

- [1] A. A. Hassen, J. Lindahl, X. Chen, B. Post, L. Love, and V. Kunc, "Additive manufacturing of composite tooling using high temperature thermoplastic materials," in *SAMPE Conference Proceedings*, Long Beach, 2016, pp. 23–26.
- [2] T. Altan, B. Lilly, and Y. C. Yen, "Manufacturing of dies and molds," *CIRP Annals*, vol. 50, pp. 404–422, 2001.
- [3] H. Vangerko, "Composite tooling for composite components," *Composites*, vol. 19, pp. 481–484, 1988.
- [4] AB. Arcam, "Case study: additive manufacturing of aerospace brackets," *Advanced Materials & Processes*, pp. 19, 2013.
- [5] G. Kim, and R. Sterkenburg, "Manufacturing or repairing composite parts and components using laser scanning technology," in *Proceedings of the American Society for Composites*, 2017.
- [6] V. Kunc, J. Lindahl, R. Dinwiddie, B. Post, L. Love, M. Matlack, R. L. Fahey, and A. A. Hassen, "Investigation of in-autoclave additive manufacturing composite tooling," in *CAMX Conference*, Anaheim, 2016.
- [7] P. D. Hilton, "The future of rapid manufacturing," in *Rapid Tooling: Technologies and Industrial Applications*, New York: Marcel Dekker Inc., 2000.
- [8] E. Lacoste, K. Szymanska, S. Terekhina, S. Freour, F. Jacquemin, and M. Salvia, "A multi-scale analysis of local stresses development during the cure of a composite tooling material," *International Journal of Material Forming*, vol. 6, pp. 467–482, 2013.