

Implementing a Prototype System for Power Facility Management using RFID/WSN

Young-Il Kim, Bong-Jae Yi, Jae-Ju Song, Jin-Ho Shin, and Jung-Il Lee

Abstract—Firstly, research and development on RFID focuses on manufacturing and retail sectors, because it can improve supply chain efficiency. But, now a variety of field is considered the next research area for Radio Frequency Identification (RFID). Although RFID is infancy, RFID technology has great potential in power industry to significantly reduce cost, and improve quality of power supply. To complement the limitation of RFID, we adopt the WSN (Wireless Sensor Network) technology. However, relevant experience is limited, the challenge will be to derive requirement from business practice and to determine whether it is possible or not. To explore this issue, we conduct a case study on implementing power facility management system using RFID/WSN in Korea Electric Power Corporation (KEPCO). In this paper we describe requirement from power industry. And we introduce design and implementation of the test bed.

Keywords—Power Facility Management, RFID/WSN, Transmission Tower, Underground Tunnel, ZigBee.

I. INTRODUCTION

A typical scenario of RFID is supply chain management. It aims at reducing supply chain inefficiencies and improved inventory flow while considering the returns process [1]. By now RFID has been used in many areas, such as marathon races, airline luggage tracking, electric security keys, toll collection, and asset tracking [2]. Also research and development on applying RFID to power industry have conducted progressively. But, there are problems still waiting to resolved, including short reading range, interference with other frequency and device, low reading rate, security issues, etc. Nevertheless, some firms are implementing RFID on a small scale and many firms are joining together to develop and promote the technology [3].

The basic premise behind RFID system is that it marks items with tags. In other words, RFID tags store an identification number. A reader retrieves information about the ID number from a database, and acts upon it accordingly. RFID tag can also contain writable memory, which can store information for power facility [4]. And RFID has many beneficial features over

traditionally used bar code. First, it doesn't require line-of-sight access to read. Second, the reading range of RFID is larger than barcode. Finally, Tag can store more data, such as the unique ID and specific data. So, it can mark power facility with tags, store identification number pertaining to power facility, identify the power facility with reader at long distance, about 10m.

A tag is usually attached directly to the object to identify. Usually, in electric industry, tag will be attached to metals, have strong effects on the performance of UHF tag antenna; in the worst case, tags may be unreadable at normal range. So, after considering attached material, we have to choose tag. RFID tags fall into two general categories, active and passive, depending on their source of electric power [4]. Active tag has larger reading range than passive tag because it has its own power source. So, it can transmit a stronger signal, and readers can access from further away. But, it is expensive. In power industry, long reading range is required. In prototype system we used passive tag, considering cost and power source.

Basic function of RFID is recognizing of tag ID which attached on object. But it is not enough to service real business area with this. So many researches use RFID information combined with sensor data. RFID and sensor network will play a key roll in USN (Ubiquitous Sensor Network). They have much advantage of massive deployment and practicality [5]. With this technology, we could recognize the power facility by RFID and access conditional data of power facility such as temperature of tape molded joint of transmission line using WSN. This method provides detection of overheated facility and prevention of fault and improves reliability of transmission network. We design and implement the power facility management system, with RFID tag and various sensors. We focused on the possibility of real time data acquisition of transmission tower and underground tunnel.

We organize this paper as follows: the next section describe RFID and its related study. In Section Three, we describe requirement derived from power business practice, including background of the KEPCO and the project. Section four introduces prototype system developed to whether RFID/WSN can be applied to power industry in terms of technology. Section Five discusses test result of the test bed, while last section provides closing remarks.

Manuscript submitted October 9, 2001.

Young-Il Kim is with the Korea Electric Power Research Institute (phone: 82-42-865-5966; fax: 82-42-865-5804; e-mail: yikim@kepri.re.kr).

Bong-Jae Yi is with the Korea Electric Power Research Institute (e-mail: bjlee@kepri.re.kr).

Jae-Ju Song is with the Korea Electric Power Research Institute (e-mail: jjsong@kepri.re.kr).

Jin-Ho Shin is with the Korea Electric Power Research Institute (e-mail: jinho@kepri.re.kr).

Jung-Il Lee is with the Korea Electric Power Research Institute (e-mail: lji3651@kepri.re.kr).

II. RELATED STUDY

A. RFID Technologies

As RFID technology enables to automatically identify each item by using radio waves and it replaces 'barcode' technology because of its contact-less recognition, batch processing of data, and reusability of information. Contact-less recognition between RFID tag and reader provides much flexibility and RFID technology gives longer recognition range than any other, such as barcode, smart cards.

The Auto-ID Center was founded in 1999 and is headquartered at MIT. The goal of its work is to build a worldwide standard and create building blocks that are needed for an effective infrastructure that no longer needs human interaction and that is accessible by the whole supply chain. EPCglobal, Inc. [6] is a joint venture company between EAN International and UCC (Uniform Code Council) to launch the efforts to drive global, multi-industry adoption of the EPC Network. All the research activities developed by Auto-ID Center moved onto the EPCglobal and its purpose is to commercialize the EPC RFID system. EPC Network has a layered structure from RFID tag to external application. EPCglobal has a standard topic of interface between layers.

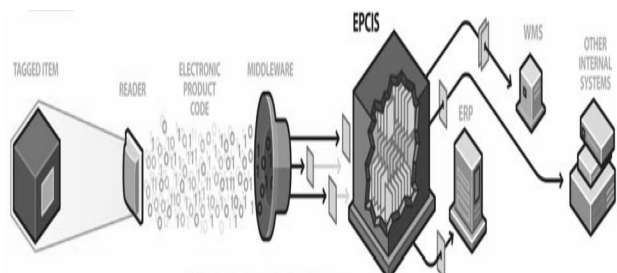

Fig. 1 EPCglobal network

Fig. 1 shows how EPC Network is organized and interacts with each other and external applications. First, a tagged object is identified by a tag and a reader [6]. EPC (Electronic Product Code), the numbering scheme to identify each unique product instance, is written on the tag and the reader captures the code and sends it to the middleware. Middleware filters and summarizes the tag data, and sends it to external applications. Summarizing and filtering of tag data is a main function of EPCglobal Network. Because middleware minimizes the amount of data and send it to external application through EPCIS, it reduces the work overload of application.

Gillette has been a leader in the effort to develop the warehousing resource management applications using EPCglobal Network. They reported that EPC provided the ability to track products to make sure they are on shelf when the consumer wants to buy them. They tested and piloted RFID project in many area such as distribution of goods, inventory management and so on. With the help of the RFID technology, they have reported the ability of product track and trace, a reduction of inventory, a reduction in labor and capital, an increase in operations accuracy, and an improved capability to address out-of-stock situations [7].

B. Wireless Sensor Network

Wireless sensor network gives the low-cost, low-power and wireless multifunctional sensor devices that are small in size and communicate over short distances. WSN can be used various application area such as military, environment, health, home and so on [8]. One of first instantiation of this concept is the Smart Dust project [9]. Sensor nodes have a wireless communication capability including processing signal and data dissemination. WSN has two hot topics. One of issues is energy conservation and the other is routing mechanism. It is important to solve the problem of the optimal WSN design in application, to minimize the network cost with lifetime constraints [10]. There are two leading international standards for low-power wireless communications.

Bluetooth. In the middle of the 1990s, Ericsson started research of Bluetooth. This technology was designed to provide user-friendly interface and reliable communication and security. Bluetooth has been standardized by IEEE 802.15.1. It uses a master/slave based MAC protocol and enables low power, short range wireless connection between various electronic devices. It is a technology to replace the hardwired connecting portable and/or fixed electronic device over relatively short distances. It provides a 1 Mbit data rate in master slave configuration and is suitable for both data and voice transmission. It can be used for program upload or download as well as data transfer [11]. But it is not suitable for sensor networking because of high complexity and power problem of sensors.

ZigBee. The ZigBee Alliance released a new standard in 2004 aiming at control and sensor application. ZigBee is designed for wireless networks providing reliability, scalability, ease of deployment, long battery life, security and low cost. It provides very low-power, low-speed, wireless networking. It has been standardized by IEEE 802.15.4. ZigBee mainly aims at cost-sensitive industrial, home building control, automation, security, consumer electronics, PC peripherals, medical monitoring and so on. This kind of application needs a long battery life and the ability to easily add or remove network nodes. ZigBee standard support star, mesh, and hybrid network architecture [12]. Unlike the Bluetooth, ZigBee provides sleep mode to conserve power during most of the idle time.

Bluetooth vs. ZigBee. ZigBee and Bluetooth are two solutions for two different application areas. A simple comparison table between Bluetooth and ZigBee technologies is shown below [12]:

TABLE I
COMPARISON BETWEEN BLUETOOTH AND ZIGBEE

	Bluetooth	ZigBee
Protocol standard	IEEE 802.15.1	IEEE 802.15.4
Application Focus	Monitoring & Control	Cable Replacement
System Resources	4KB~32KB	250KB+
Battery Life (days)	100~1,000+	1~7
Network Size	Unlimited	7
Bandwidth(KB/s)	20~250	720
Transmission Range(m)	1~100+	1~10+

Success Metrics	Reliability, Power, Cost	Cost, Convenience
-----------------	-----------------------------	----------------------

C. Power Transmission Line Inspection & Monitoring

In the electric power industry, since the power facility have uncertain lifetime, the troubles, like power failure, should take place at any time. Therefore the inspection of the systems and equipment are very important for normal operation of power transmission lines. For this reason, utility companies perform an inspection tasks by workers with telescope on the ground or air using helicopter. These tasks have many disadvantages in cost and safety. To solve this problem, an inspection robot was developed for the power transmission line inspection that can know running conditions and find damages of power transmission line equipment [13]. To stabilize the control of electric power systems, it is necessary to monitor a current and voltage of power transmission line. For this reason, monitoring equipment was developed to monitor current and voltage of transmission line [14].

III. BUSINESS REQUIREMENT FROM ELECTRIC POWER INDUSTRY

In the electric power industry, there is a strong need to apply RFID/WSN technologies to control and monitor the power facility, so as to avoid possible power failures. It is important that the supply of energy must always be guaranteed. To satisfy these requirements, various forms of technologies are needed, such as RFID tag, reader, sensor network, middleware and so on. RFID/WSN technologies of the electric power industry are in the early stage now. There is no clear guideline for developing electric facility management system based on RFID/WSN. So we focus on researching of field requirement, technical possibility of implementation and field test of proto-type. We take into account the requirements interviewed with working level officers, operators and technicians. These requirements are classified in four applicable subjects using RFID/WSN: object identification, offline data storage of facility information, verification for inspection, real-time acquisition of facility information.

Object identification. RFID technology is useful to identify the power facilities such as power tower, concrete pole, insulator, and so on. It is hard to distinguish the many facilities by the eye and input the facility ID manually to inspection system of PDA. A RFID tag, reader and PDA application provide a convenience method of object identification and data input to the inspector.

Data storage. A RFID tag has a re-writable user memory. We can use this memory area to store the inspection history. Generally, power facilities are located in out-door and facilities information are stored in database system. If field worker want to know the facility's history in out-door with mobile devices like PDA, it need a wireless communication to receive facility information. In this case, if facility information is stored in user memory of a tag, worker can access historical information by hand-held RFID reader on site.

Verification for inspection. Many utility companies contact out the inspection of power distribution line. Contacted

company inspects the distribution line and report the result to utility company. In this case, It is important to check whether they inspect the exact facility on correct time or not. This requirement can be satisfied with RFID technologies. We place RFID tags to facilities and developed mobile inspection application. When inspector read a RFID tag with hand-held reader, facility information and timestamp is recorded in PDA automatically. This method can improve the reliability of inspection report.

Real-time acquisition of facility information. In hot summer, the consumption of electricity is increased rapidly, because of air-conditioning. It makes an overload of the transformer and causes the explosion. To prevent this situation, utility developed a power transmission monitoring system. With a monitoring system, the details of an electrical system can be monitored and observed by electricians or operators who would monitor, make a decision and react to faults. However, a monitoring system would require much equipment, time and cost. As a result, a monitoring system usually contained monitoring equipment only on highly important position. Recently, wireless sensor network like ZigBee is interested in monitoring and control applications of electrical system, because it saves the cost of wiring and installation and also to allow more flexible deployment of system. A traditional wired thermal sensor may cost less than a ZigBee sensor, but ZigBee sensor does not need installation cost, just placing it. We developed a proto-type power transmission line monitoring system of underground tunnel with WSN technology. This can reduce the installation cost and improve the effectiveness of power transmission line by providing much information of essential facilities in real-time.

IV. IMPLEMENTATION OF PROTOTYPE SYSTEM

Continual Inspection and monitoring of facility is needed to maintain the stability of the power facility. In this research, we implemented three kinds of applications: distribution line inspection system, transmission tower monitoring system and underground tunnel monitoring system.

A. Distribution Line Inspection System

A periodical inspection of the power distribution line is done by the inspector moving along the distribution line to check the power facility directly. Currently, the inspector uses the PDA to input the facility information manually. This method has a shortcoming of cumbersome manual input and possibility of arbitrary data input without going to relevant area.

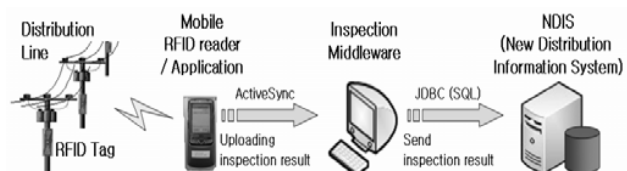

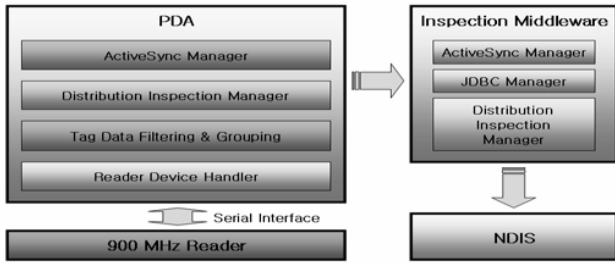

Fig. 2 System diagram and S/W architecture

We developed the PDA based distribution line inspection system which could input the data automatically only after recognizing the tag that was attached on tower and show the previous inspection data which was stored in user memory of the tag.

Fig. 2 is developed schematic system diagram and software architecture. The inspector arrives in work field and runs the distribution line inspection manager program with PDA. By recognizing the tag which was attached in concrete pole with hand-held RFID reader, PDA program reads the historical inspection data from the tag, shows the historical reports and gets a new inspection information from the inspector and stores to the tag again. After Completing all inspection, the inspector returns to the office and connects PDA to personal PC and runs inspection middleware to communicate inspection result to NDIS (NIDS is a New Distribution Information System which was developed and operated in KEPCO.). We could get a benefit of improved reliability of inspection result and automation of data input.

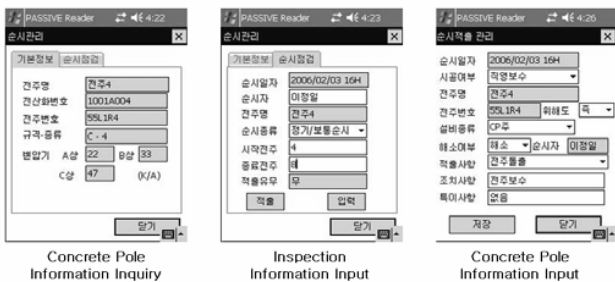

Fig. 3 Example of distribution line inspection manager

B. Transmission Tower Monitoring System

The TGIS (Transmission & Substation Geographic System) which is operating in the KEPCO offers real time monitoring for electric power facilities using traditional wired sensing technology. But these methods are not applied in all facilities, because of high installation and maintenance costs.

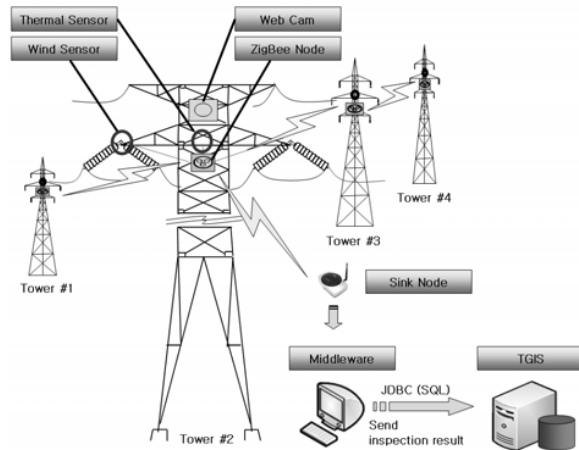

Fig. 4 Diagram of transmission tower monitoring system

The transmission tower monitoring system using WSN is developed in this research. This system provides real-time tower supervision with relatively low costs. We install the thermal sensor node based on ZigBee (2.4GHz) on four 765kV power tower which is located in GoChang Electric Power Test Center owned by KEPCO. Additionally, we install the wind speed and direction sensor and the web camera on No.2 tower. We just use the Sony's web camera solution to watch a surrounding situation of the tower and it uses wireless internet protocol not ZigBee.

Monitoring of temperature, wind speed and direction of tower is an important factor to forecast the safety of a tower structure. By collecting real-time information from tower, facility manager improves the ability of remote monitoring and decision making whether it needs to repair or not. Each sensor node does a synchronized communication to save the power by sleep and wake up mechanism every 15 minutes. We solve the power problem with the solar cell which is used to charge the battery during the daytime.

Sensor nodes uses ad-hoc networking algorithm to communicate each other. Sensor nodes make a network dynamically and send a data to sink node. When failure occurs, they reconstruct a network automatically. The sink node acquires data from sensor node using ZigBee communication and sends acquired data to wireless access point in office located near tower using TCP/IP protocol. The middleware sends data to the TGIS which is situated in the head office.

TABLE II
SPECIFICATION OF SENSOR NODE AND SINK NODE

	Sensor Node	Sink Node
Protocol	ZigBee Module (2.45GHz)	ZigBee Module (2.45GHz), Wireless LAN
Antenna	ANT (dipole ANT 12dBi)	
Sensor	Thermal, wind speed & direction	None
Power	Battery (4.2V, 4.2A) Solar cell (max: 12V, 360mA)	Commercial 220V power line



Fig. 5 Web screen of transmission tower monitoring system

C. Underground Tunnel Monitoring System

Underground tunnel is made to connect a power transmission line with power tower when tower can not be built through the downtown area. In this case, unlike wire which is used for tower, insulated cable is used. Because of transportability, cable length is limited about 300m. So both cables are connected every 300m and this point is called joint section. Joint section is a most sensitive facility in underground tunnel. Temperature of joint section is increased along with power consumption. Therefore, temperature monitoring of joint section is important to monitor overload of power transmission line. The underground tunnel has a problem of air circulation, because it is sealed in underground. So it needs to inspect amount of gas to prevent the accident by poisonous gas.

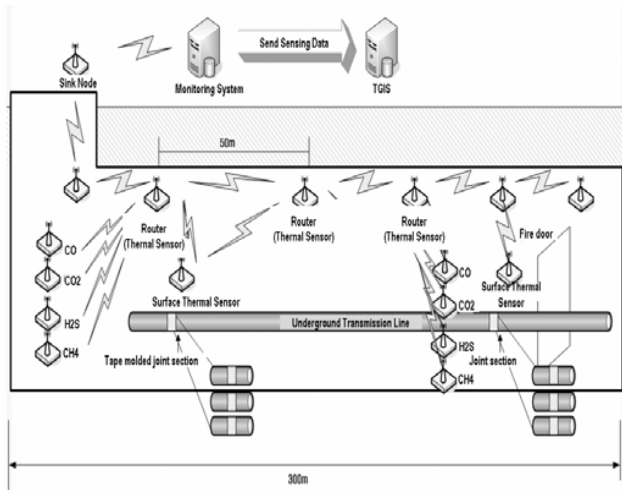

Fig. 6 Diagram of underground tunnel sensor network

The underground tunnel monitoring system is developed in this research. We place thermal sensors about 25~50meters apart in 600 meters tunnel. These nodes are called router node which charge the role of a relay node and sensor node of air temperature. We arrange the router node in linear order following the tunnel, because of the environment characteristic of underground tunnel. We design a static routing algorithm. It uses a 16 bit short address instead of 64bit IEEE addresses to

reduce the packet size. A node communicates with another one-by-one which is predefined in static routing table. Nodes receive a packet from a successor and send a packet to a predecessor. This method is similar with clustered tree of ZigBee network which has only one child node.

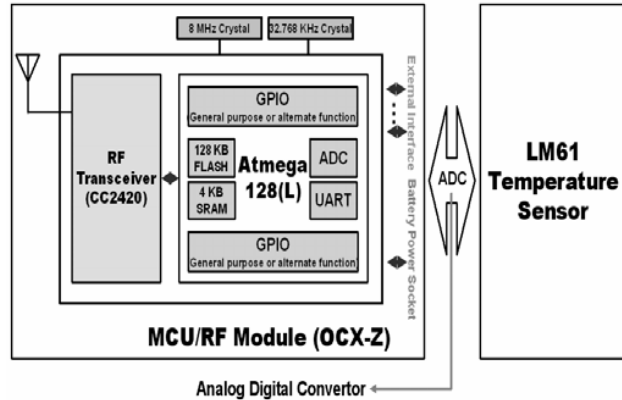

Fig. 7 Architecture of thermal sensor

We design a dynamic routing at the first time which changes the routing path dynamically by adding the new node. But it has a power consuming problem. It wastes much power to check the routing status, generate communication packet to establish the new routing path and increase wake up time to synchronize each other. Unlike power tower, in the underground tunnel, it is important to conserve the battery life, because recharging technology like solar cell is not available. We need a simple wireless network in tunnel. So we use a static routing to conserve a battery life.

The surface thermal sensor node that measures surface temperature of joint section has three thermal sensors and measures center and both end of joint section. In case temperature differences of three points over five degrees, it alarms a warning of over heating of the joint section. Additionally, we place various gas sensors (temperature, carbon monoxide (CO), carbon dioxide (CO2), oxygen (O2), hydrogen sulfide (H2S), and methane gas (CH4)) in joint section which is placed at intervals of 300 meters. In case of gas sensor, it is not commercialized so far which is specialized in wireless sensor networking and low power consuming. So we use a normal industrial sensor which is not effective in wireless sensor network. This is the main cause of static routing of this system.

We develop a sensor network communicating with sleep and wake up method to synchronize periodically. Sink node, having a permanent power, sends a synchronization packet to sensor node to synchronize each other. Sleep time interval can be changed with a monitoring system and propagate from sink node to sensor node with control signal. Generally, sensor node sequentially receives a synchronization packet and control packet after wake up. Then it sends sensing data to sink node.



Fig. 8 Synchronization of message

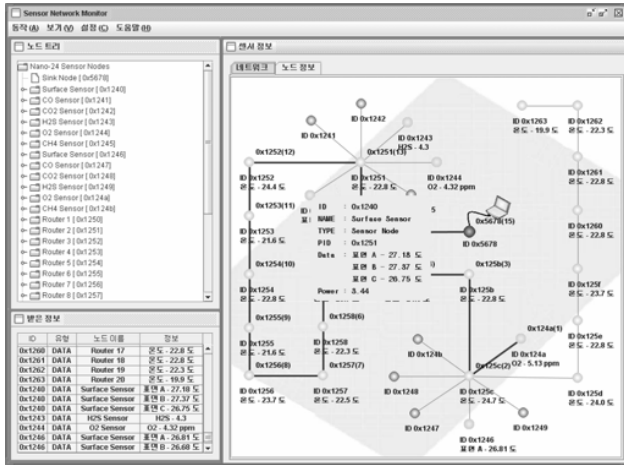

Fig. 9 Screen example of sensor network monitoring

To activate the sleep and wake up method with all sensor nodes, it is important to make an exact synchronization. We use a various kinds of sensor and they take a different time to sense. The thermal sensor takes several hundred millisecond and gas sensors take several seconds. So we design to wake up not together but respectively depending on the sensing time. The sensor node wakes up earlier amount of required time for sensing before wake up time schedule. It receives synchronization packet after finished sensing.

V. CONCLUSION

To apply the RFID/WSN technology to specific industry, it is necessary to search for the way to apply and make the prototype system to help the business and technical judgment of applicability. In this paper, the proposed prototype system has been developed for verifying the possibility of electrical industry application using RFID/WSN to manage the electric facility. We expect to increase the automaticity in inspection and reduce the input mistake. By providing real time monitoring data of transmission line, it can improve the efficiency of work process and strengthen the competitiveness of electric industry.

We will develop the dynamic routing algorithm which is suitable for linear wireless sensor network such as power transmission line and reduces the power consuming. We will upgrade and stabilize the prototype system to apply the working field in the future.

REFERENCES

[1] Xingxin Gao, "An approach to security and privacy of RFID system for supply chain", E-Commerce Technology for Dynamic E-Business, 2004. IEEE International Conference on ,2004 pp:164 – 168.
 [2] Srivastava, B., "Radio Frequency ID technology: The next revolution in SCM", Business Horizons vol. 47, no. 6, 2004, pp.60-68.

[3] Shang-Wei Wang, Wun-Hwa Chen, Chornng-Shyong Ong, Li Liu, Yun-WenChuang, "RFID application in hospitals: a case study on a demonstration RFID project in a Taiwan hospital", HICSS '06. Proc. of 39th Annu Hawaii International Conf., Vol. 7, pp184a-184a.
 [4] Weinstein, R.; "RFID: a technical overview and its application to the enterprise", IT Professional, Vol. 7, No. 3, 2005, pp.27-33.
 [5] Sanchez Lopez, Daeyoung Kim, Taesoo Pak, "A service framework for mobile ubiquitous sensor networks and RFID", Wireless Pervasive Computing, 2006, pp 1~6.
 [6] EPCglobal Inc, "The EPCglobal network: overview of design, benefits, and security", Available: <http://www.epcglobalinc.org>.
 [7] "An interview with Dic Cantwell", June, RFID Journal 2003.
 [8] I.F. Akyildiz, "Wireless sensor networks: a survey", Computer Network Vol. 38, Issue 4, 15 March 2002, pp. 393-422.
 [9] J.M. Kahn, R.H. Katz, and K.S.J. Pister, "Emerging challenges: mobile networking for smart dust", Journal of Communications and Networks, Vol. 2, No. 3, 2000, pp. 271– 278.
 [10] Kenan Xu, Quanhong Wang, H. Hassanein, G. Takahara, "Optimal wireless sensor networks (WSNs) deployment: minimum cost with lifetime constraint", Wireless And Mobile Computing, Networking And Communications, 2005. (WiMob'2005), Vol. 3, 2005, pp.454 – 461.
 [11] "Specification of the Bluetooth system", November, 2003, Available: <http://www.bluetooth.org>.
 [12] Patrick Kinney, "ZigBee technology: wireless control that simply works", Available: <http://www.zigbee.org>.
 [13] Tang Li, Fang Ljin, Wang Hongguang, "Development of an inspection robot control system for 500KV extra-high voltage power transmission lines", SICE 2004 Annual Conference, Vol. 3, 4-6 Aug. 2004, pp.1819-1824.
 [14] E. Nishiyama, K. Kuwanami, M. Kawano, T. Matsuda, I. Oota, "Development of portable equipment for monitoring currents and voltages of power transmission lines", ISIE 2002, Vol 3. 26~29 May 2002, pp. 964-969.