

# High-Frequency Spectrum Analysis of VFTO Generated inside Gas Insulated Substations

M. A. Abd-Allah, A. Said, and Ebrahim A. Badran

**Abstract**—Worldwide many electrical equipment insulation failures have been reported caused by switching operations, while those equipments had previously passed all the standard tests and complied with all quality requirements. The problem is mostly associated with high-frequency overvoltages generated during opening or closing of a switching device. The transients generated during switching operations in a Gas Insulated Substation (GIS) are associated with high frequency components in the order of few tens of MHz.

The frequency spectrum of the VFTO generated in the 220/66 kV Wadi-Hoff GIS is analyzed using Fast Fourier Transform technique. The main frequency with high voltage amplitude due to the operation of disconnector (DS5) is 5 to 10 MHz, with the highest amplitude at 9 MHz. The main frequency with high voltage amplitude due to the operation of circuit breaker (CB5) is 1 to 25 MHz, with the highest amplitude at 2 MHz.

Mitigating techniques damped the oscillating frequencies effectively. The using of cable terminal reduced the frequency oscillation effectively than that of OHTL terminal. The using of a shunt capacitance results in vanishing the high frequency components. Ferrite rings reduces the high frequency components effectively especially in the range 2 to 7 MHz. The using of RC and RL filters results in vanishing the high frequency components.

**Keywords**—GIS, VFTO, Mitigation Techniques, Frequency spectrum, FFT, EMTP/ATP.

## I. INTRODUCTION

**G**AS Insulated Substations are widely used in power systems because of their high reliability, easy maintenance and small ground space requirements. The unique problem in GIS is that the generation of very fast transient overvoltages, VFTO, during the operation of disconnector and circuit breakers. The tip of which is very steep accompanied with high frequency oscillation. They have very short rise times, in the range of 4 to 100ns, and are normally followed by oscillations having frequencies in the range of 100 kHz to 50 MHz [1], [2]. VFTO not only influence the operating reliability of GIS, but also causes great threat to the insulation of the high-voltage equipment, especially to windings of the transformer. This can be referred to the fact that the instant of contacts breakdown can generate VFTO, whose tip is very steep, which makes the voltage distribution on the windings uneven or the frequency of the oscillating wave can

matched to the natural frequency of the equipment in the VFTO, which causes an overvoltage with a very high amplitude, which can damage the insulation of the equipment [1]-[6].

The frequency spectrum of the VFTO generated in the 220/66kV Wadi-Hoff GIS is analyzed using Fast Fourier Transform, FFT [6]. The analysis is done for the worst case for disconnector and circuit breaker switching which generated high values of VFTO at the transformer terminals. Also, the frequency spectrums with using different mitigating techniques are presented and compared with those without using the mitigating techniques.

## II. MODELING OF THE 220 kV WADI-HOFF GIS

Due to the traveling nature of the transients, the different components can be modeled by distributed parameter lines, surge impedances and traveling times. Each GIS section is simulated by its equivalent capacitance and inductance, which can be determined as follows [2], [3], [7].

$$C = \frac{2\pi\epsilon}{\ln \frac{D}{d}} \quad (\epsilon \approx \epsilon_0) \quad F/m \quad (1)$$

$$L = \frac{\mu}{2\pi} \ln \frac{D}{d} \quad H/m \quad (2)$$

$$Z_0 = \sqrt{L/C} = \frac{\sqrt{\epsilon\mu}}{2\pi} \ln \frac{D}{d} \approx 60 \ln \frac{D}{d} \quad \Omega \quad (3)$$

$$v = \frac{1}{\sqrt{LC}} \quad m/s \quad (4)$$

where, C and L are the capacitance and the inductance of the GIS busbar, respectively. d is the outside diameter of the GIS busbar and D is the inner diameter of the GIS enclosure.  $Z_0$  is the surge impedance and v is the propagation velocity.

The single line diagram of the substation under study is illustrated in Fig. 1. The 220/66/11 kV Wadi-Hoff substation under study consists of four incoming feeders, two feeders each of 30km length, and the other two feeders each of 3km length. The substation includes three 125 MVA, 220/66/11 kV, power transformers. The feeders are connected in a two busbar arrangement with a bus coupler. The equivalent circuits of the different GIS components and the values of the different

M. A. Abd-Allah is with the Faculty of Engineering at Shoubra, Benha University, Egypt.

A. Said is with the Faculty of Engineering at Shoubra, Benha University, Egypt (e-mail: abdo\_eng1987@yahoo.com).

Ebrahim A. Badran is with the Faculty of Engineering, Mansoura University, Egypt.

parameters in the simulation can be summarized as follows; The characteristic impedance and the propagation velocity of GIS busbar can be taken as  $70\Omega$  and  $270\text{m}/\mu\text{s}$ , respectively. The impedance of the circuit breaker in the closed position is taken as  $70\Omega$ , while in the opening position is taken as  $90\text{pF}$  from both end to ground and  $50\text{pF}$  between contacts. The impedance of the disconnecter in the closed position is taken as  $70\Omega$ , while in the opening position is taken as  $30\text{pF}$  from both end to ground and  $30\text{pF}$  between contacts. The impedance of the potential transformer is taken as  $100\text{pF}$  towards ground. The characteristic impedance and the propagation velocity of current transformer can be taken as  $70\Omega$  and  $270\text{m}/\mu\text{s}$ , respectively. The surge arrester is simulated

by  $200\text{pF}$  capacitance in series with a grounding resistance of  $0.1\Omega$ . The characteristic impedance and the propagation velocity of the OHTL can be taken as  $250\Omega$  and  $300\text{m}/\mu\text{s}$ , respectively. The elbows, spacers, and spherical shields are simulated by a lumped capacitance of  $15\text{pF}$  towards ground. The bushings are simulated by an impedance of  $70\Omega$  and  $100\text{pF}$  towards ground. The CB and DS restrikes are modeled as an exponentially decaying resistance in series with a small resistance  $R(t) = R(0)e^{-t/\tau} + r$ , where  $R(0)$  is  $10^{12}$  ohm and the time constant  $\tau$  is  $1\text{ns}$ .  $r$  represents the spark resistance after voltage breakdown and  $r$  is assumed to be  $0.5\Omega$  for DS and  $.01\Omega$  for CB [2], [3].

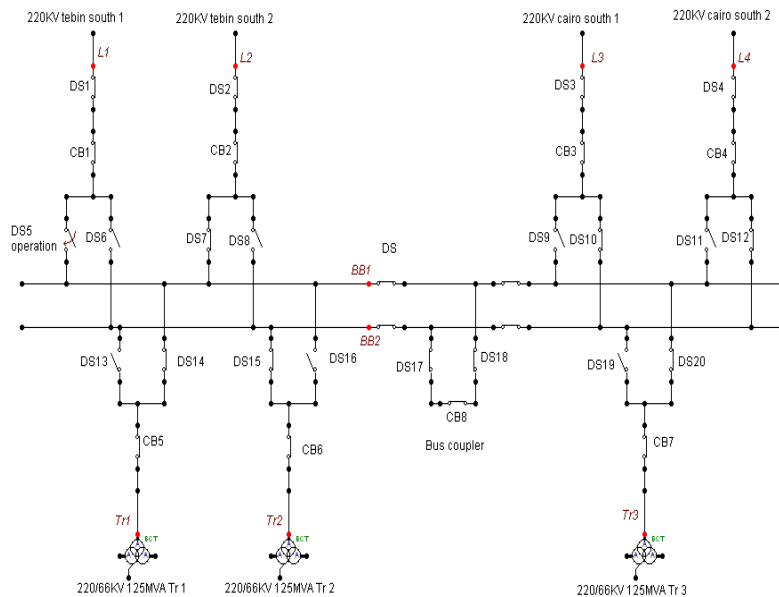

Fig. 1 Typical single line diagram for Wadi-Hoff GIS

At high frequencies, the winding of transformer behaves like a capacitive network consisting of series capacitances between turns and coils, and shunt capacitances between turns and coils to the grounded core and transformer tank [1]-[3]. So, the transformers are simulated in this work by their surge capacitances. These equivalent capacitances are in the range from  $2$  to  $10\text{ nF}$  [1], [2], [4], [6]. The transformer is modeled as a capacitor with  $2\text{ nF}$  as given in [2]. EMTP/ATP is used to simulate the substation under study.

### III. FREQUENCY ANALYSIS OF OVERVOLTAGES DUE TO DISCONNECTOR SWITCHING

The switching operation of (DS5) generates the largest values of VFTO at the transformer terminals. The VFTO generated at the transformer terminals by DS5 is shown in Fig. 2. It is observed that the peak magnitude of the generated VFTO at Tr1 is about  $2.04\text{ pu}$ , while it is about  $1.60\text{ pu}$  at Tr2,  $1.58\text{ pu}$  at Tr3,  $1.44\text{ pu}$  at L2,  $1.14\text{ pu}$  at L3,  $1.13\text{ pu}$  at L4,  $1.22\text{ pu}$  at BB1 and  $1.14\text{ pu}$  at BB2. By analyzing the frequency spectrum of VFTO, components are inhibited obviously. Fig.

3 shows the frequency spectrum of the VFTO at Tr1. It is clear that, the dominant frequency components at the switch (DS5) operation is up to  $40\text{ MHz}$ . The main frequency with high amplitudes is in the range of  $5$  to  $10\text{ MHz}$ . Frequency amplitude of  $9\text{ MHz}$  has a maximum magnitude. However, there are high frequency components with lower amplitudes in the range of  $10$  to  $40\text{ MHz}$ . These high frequency components may be due to fast voltage collapse between the switching contacts during its operation.

### IV. FREQUENCY ANALYSIS OF OVERVOLTAGES DUE TO CIRCUIT BREAKER SWITCHING

The switching operation of (CB5) generates the largest values of VFTO at the transformer terminals. Fig. 4 shows the VFTO at the transformer terminals when CB5 operates. It is observed that the peak magnitude of the generated VFTO at Tr1 is about  $2.83\text{ pu}$ , while it is about  $1.80\text{ pu}$  at Tr2,  $1.88\text{ pu}$  at Tr3,  $1.51\text{ pu}$  at L1,  $1.33\text{ pu}$  at L2,  $1.19\text{ pu}$  at L3,  $1.26\text{ pu}$  at L4,  $1.34\text{ pu}$  at BB1 and  $1.31\text{ pu}$  at BB1.

By analyzing the frequency spectrum of VFTO, components are inhibited obviously. The frequency spectrum of the VFTO generated at Tr1 is shown in Fig. 5. It is seen that, the dominant frequency components at the switch CB5 operation is upto 50 MHz. The main frequency with high amplitudes is in the range of 1 to 25MHz. Frequency amplitudes of 2 MHz has the maximum magnitude, while frequency amplitude of 3, 6, 7 and 9 MHz has considerable magnitudes. However, there are high frequency components with lower amplitudes in the range of 10 to 17 MHz and from 25MHz to 50MHz.

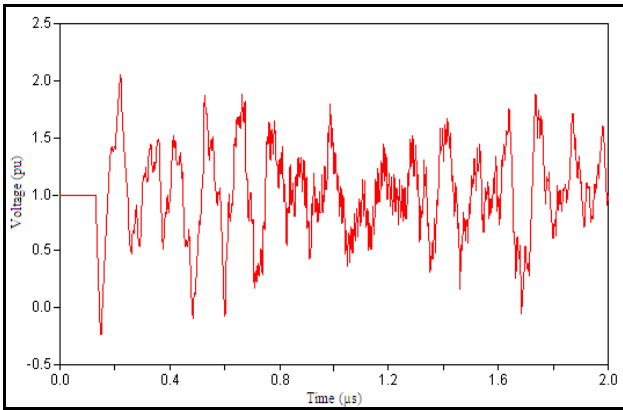

Fig. 2 VFTO at transformer terminals Tr1

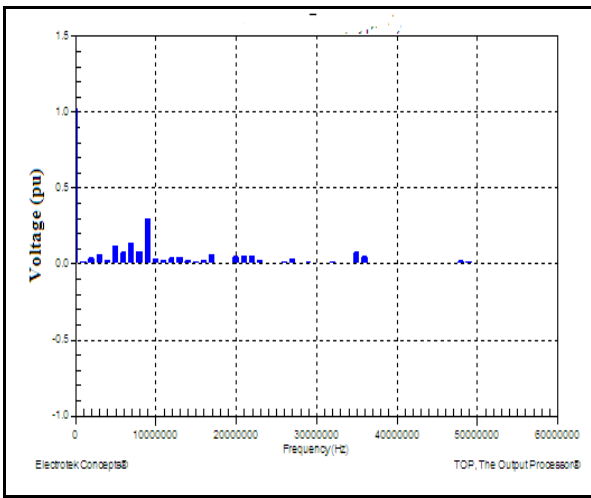

Fig. 3 Frequency spectrum of VFTO at Tr1 (Worst Case)

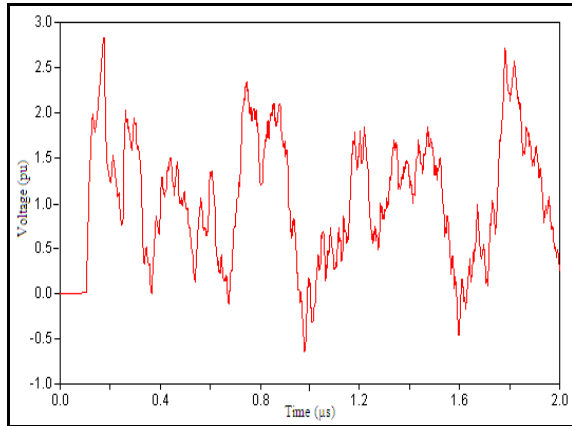

Fig. 4 VFTO at transformer terminal Tr1

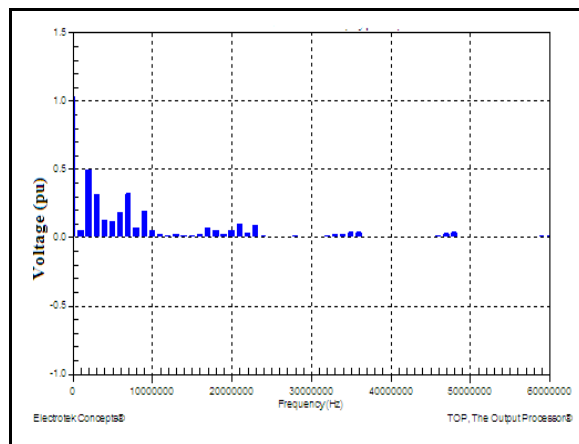

Fig. 5 Frequency spectrum of VFTO at transformer terminal Tr1

The comparison between the frequency spectrum of VFTO due to CB and DS switching operations is shown in Fig. 6. It is clear that, at a frequency range of 1 to 8MHz the VFTO is relatively higher amplitude at (CB5) switching than that at (DS5) switching. This is due to long length of gap between contacts of CB. Also at the dominant frequency components from 8 to 10MHz has lower amplitude of (DS5) than that with (CB5) operation.

### V. MITIGATION TECHNIQUES

Up to date, the main challenges are the reduction of VFTO amplitudes and oscillation frequency. The researchers concerns on finding the optimum technique for suppressing VFTO. Several techniques are used to reduce the harmful effects of the VFTO [7]-[9], [11], [12], [14].

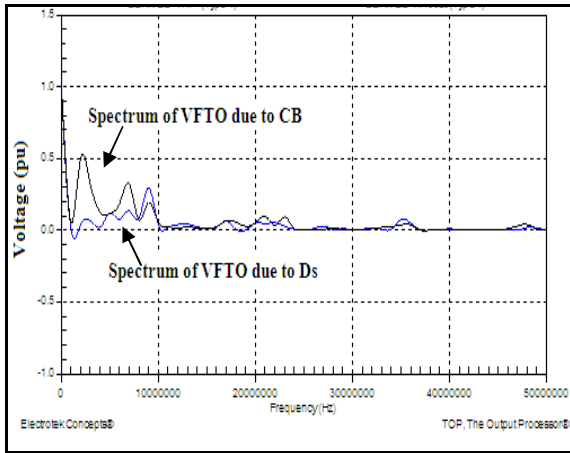

Fig. 6 Frequency spectrum of VFTO at transformer terminal Tr1

*A. The Appropriate Load Side Terminals*

The peak magnitude and frequency content of VFT depends on the terminal component connected to the GIS [8], [12]. The terminal components can be cables, or overhead transmission lines (OHTL).

At Wadi-Hoof GIS, 5 m long of an OHTL is used on the source side terminals and 11m long of an OHTL is used on the load side terminals are used. Fig. 7 illustrates a comparison between the VFTO generated at Tr1 in cases of using 11m cable at load side terminal instead of 11m OHTL. It is clear that the lowest value of VFTO is about 1.26pu with using cable terminations.

Fig. 8 shows the analyzing of the frequency spectrum of VFTO. It is clear that, the dominant frequency components appear with using cable terminal is in range from 7MHz to 13MHz but with lower amplitude. However, other high frequency component amplitude reduced until vanished.

Fig. 9 illustrates a comparison between the frequency spectrums of VFTO at Tr1 in the two load terminal cases. It is clear that the frequency component of VFTO when using cable is reduced until high frequency components vanished. These low frequency components are due to the high value of stray capacitance in cable. Therefore, the VFTO amplitude and oscillation frequency can be mitigated by replacement with the appropriate terminals. Simplicity, low cost implementation, and minimum changes in the installed GIS are the main advantages of this technique.

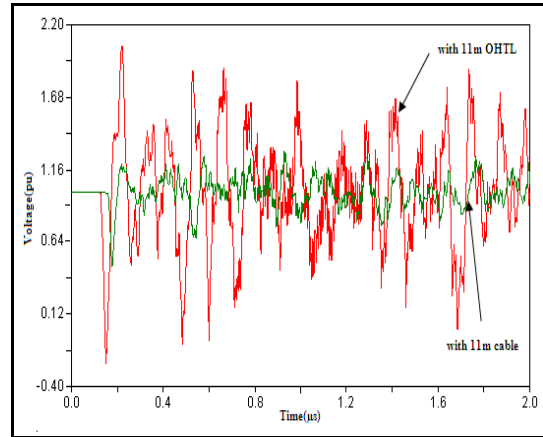

Fig. 7 Comparison between the VFTO at Tr1 in case of OHTL and Cable load terminals

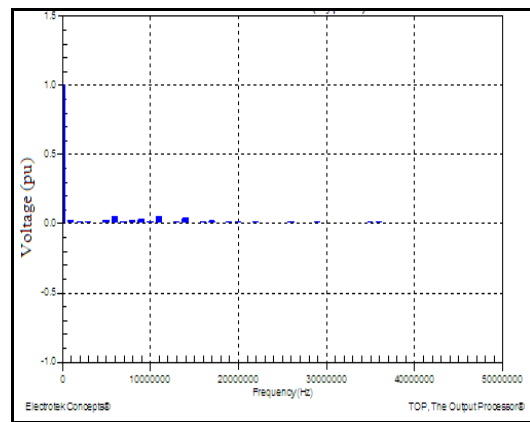

Fig. 8 Frequency spectrum of VFTO at Tr1 with 11m cable terminal

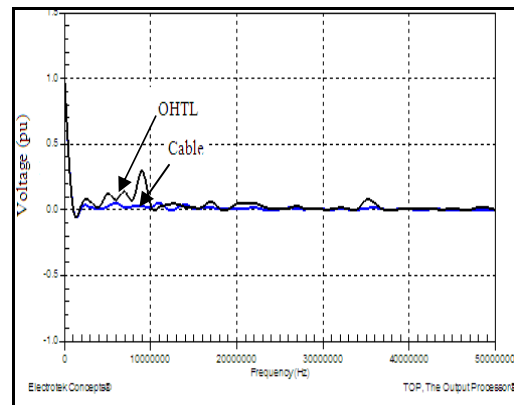

Fig. 9 Frequency spectrum at Tr1 in case of OHTL and Cable load terminals

*B. The Capacitance at Transformer Terminal*

Lumped shunt capacitance is used to damp the VFTO in many applications [2], [8]. Fig. 10 illustrates a comparison between the VFTO at Tr1 in case of without and with a capacitance of 10nF. It is clearly seen the high reduction of the value of VFTO from 2.04pu to 1.1pu.

The analyzing of the frequency spectrum of VFTO is shown in Fig. 11. It is clear that, there is no frequency components appears, i.e. high frequency component amplitude reduced until vanished. Fig. 12 illustrates a comparison between frequency spectrum of VFTO at Tr1 in case with and without using 10nF shunt capacitance. It is clear that the frequency component of VFTO when using capacitance is reduced until vanished. The use of capacitance reduces the circuit oscillation frequency.

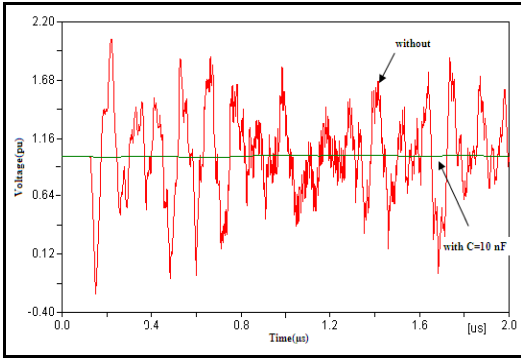

Fig. 10 Comparison between the VFTO at Tr1 in case of without and with shunt capacitance

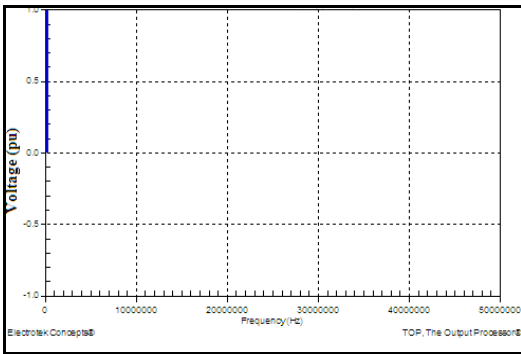

Fig. 11 Frequency spectrum of VFTO at Tr1 (using C=10nF)

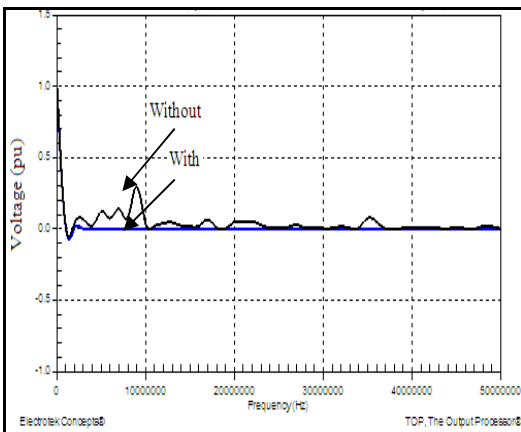

Fig. 12 Frequency spectrum at Tr1 in case of without and with shunt capacitance

C. Ferrite Rings Technique

Ferrite is a high-frequency nonlinear magnetic material. The ferrite rings is used around GIS conductors to absorb the transient energy when the DS restrikes to inhibit the VFTO [10], [12], [13].

The optimum result is found with using three rings [3]. Fig. 13 illustrates the VFTO when 3 ferrite rings are used at Tr1. It is clearly seen that the reduction of the VFTO amplitude at Tr1 to 1.23pu.

Fig. 14 shows the analyzing of the frequency spectrum of VFTO. It is clear that, the dominant frequency components appears when using three ferrite rings is in range from 2 to 7MHz but with lower amplitude. However, other high frequency component amplitude reduced until vanished.

Fig. 15 illustrates a comparison between frequency spectrums of VFTO at Tr1 in the two cases. It is clear that the frequency component of VFTO when using three ferrite rings is reduced until high frequency components vanished. These low frequency components may be due to inductance which will reduce the rate of change of the current (di/dt).

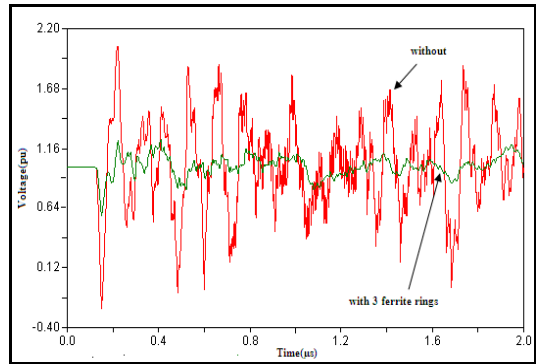

Fig. 13 VFTO at Tr1 with and without ferrite rings

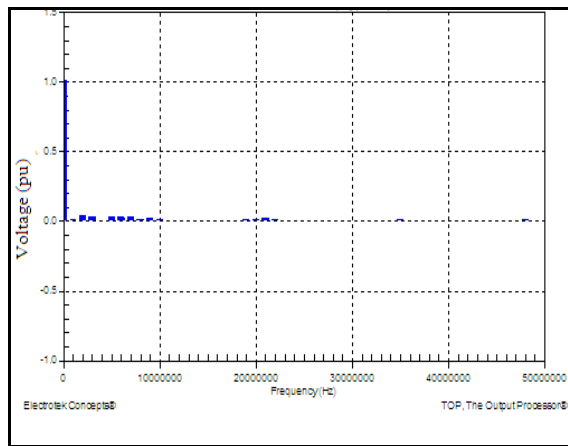

Fig. 14 Frequency spectrum of VFTO at Tr1 with three ferrite rings

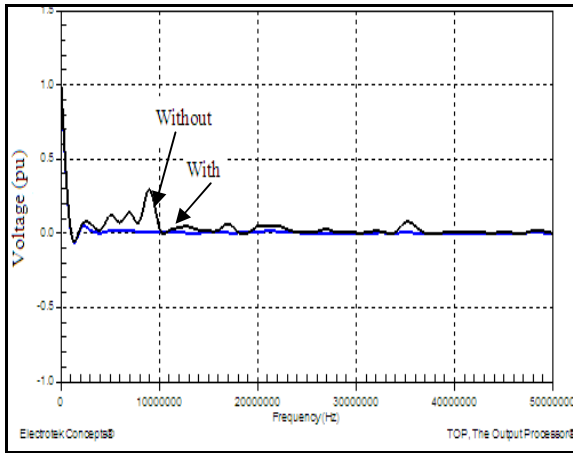

Fig. 15 Frequency spectrum at Tr1 in case of without and with Ds ferrite ring

**D. RC Filter**

RC filters (R in parallel with C) have been widely used to protect loads [13]. R is used to make energy attenuates and C reduces the circuit oscillation frequency. In this work RC filter is used as a shunt component next to the main transformer to protect it. R is varied from 50Ω to 400Ω and C is changed from 0.01 to 0.2μF. The optimum mitigation of the VFTO is found when R equal to 50Ω and at C equal to 0.01μF. Fig. 16 illustrates the VFTO when RC filter is used at Tr1. It is clearly seen that the VFTO amplitude at Tr1 is reduced to 1.008pu with using RC filter.

The analyzing of the frequency spectrum of VFTO is shown in Fig. 17. It is clear that, there is no frequency components appears, i.e. high frequency component amplitude reduced until vanished. Fig. 18 illustrates a comparison between frequency spectrum of VFTO at Tr1 in cases with and without using RC filter. It is clear that the frequency component of VFTO when using RC filter is reduced until vanished.

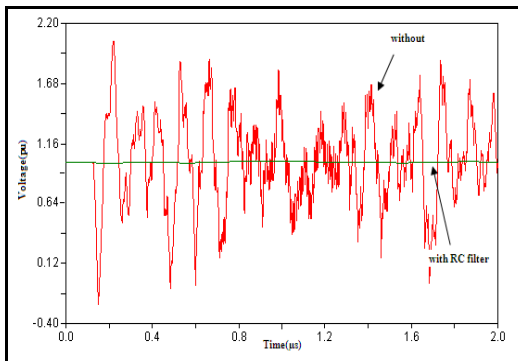

Fig. 16 Comparison between VFTO at Tr1 with and without RC Filter

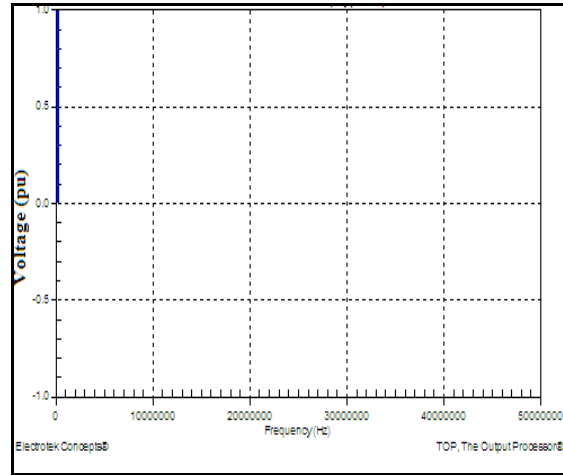

Fig. 17 Frequency spectrum of VFTO at Tr1 with RC filter

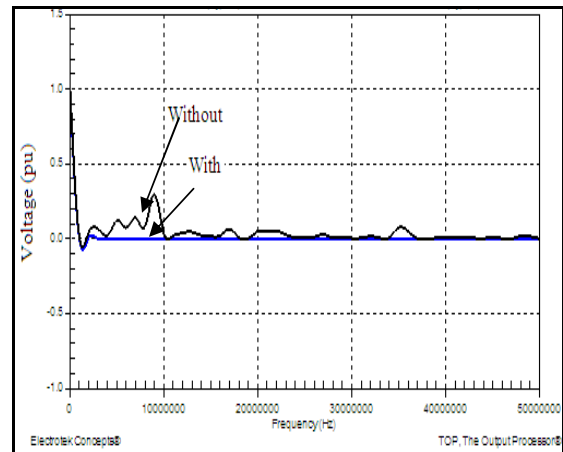

Fig. 18 Frequency spectrum at Tr1 in case of without with RC filter

**E. RL Filter (Shunted Inductor)**

VFTOs at transformer terminals are associated with high electric field, so the utilizing of a reactor will convert electric field into magnetic field which absorbs the energy of VFTO, resulting in the reduction of its magnitudes.

Fig. 19 shows the VFTO at transformer terminal (Tr1) with and without using a shunt reactor. The inductance of the reactor is used as 1μH in series with a resistor of 10Ω, both shunted with the transformer to protect it and also to give an optimum solution. The maximum voltage to ground at transformer, Tr1 reaches a value of about 1.03pu.

The analyzing of the frequency spectrum of VFTO is presented in Fig. 20, it is clear that, there are no frequency components appears, i.e. high frequency component amplitude reduced until vanished. Fig. 21 illustrates a comparison between frequency spectrum of VFTO at Tr1 in case with and without using RL filter. It is clear that the frequency component of VFTO when using RL filter is reduced until vanished.

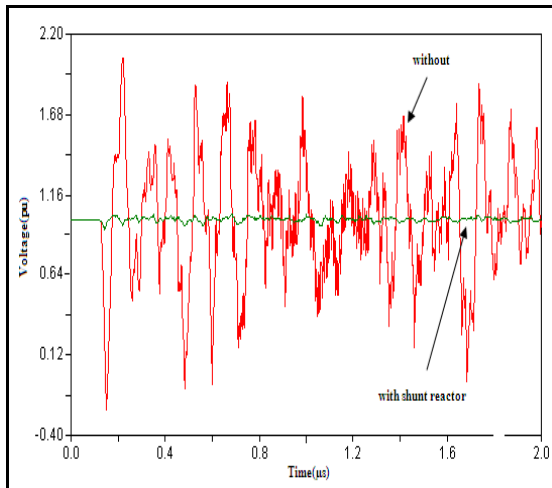

Fig. 19 VFTO at Tr1 terminal with and without reactor

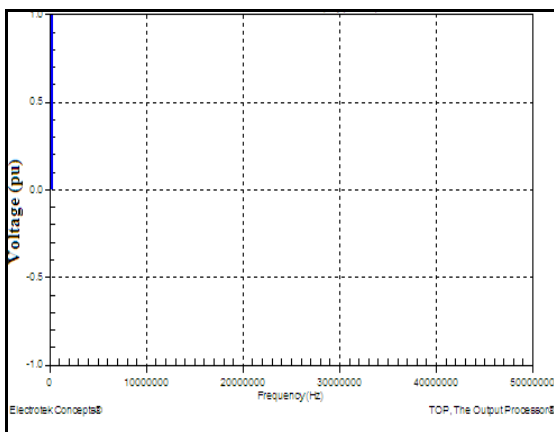

Fig. 20 Frequency spectrum of VFTO at Tr1 (using RL filter)

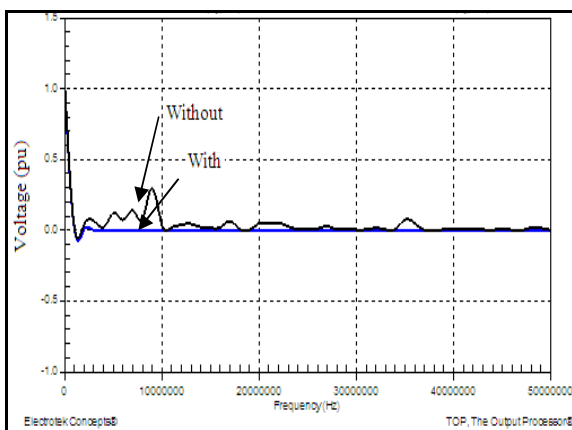

Fig. 21 Frequency spectrum at Tr1 in case of without and with RL filter

## VI. CONCLUSION

Many insulation failures have been reported worldwide due to switching operations. The problem is mostly associated with high-frequency overvoltages generated during circuit

breaker and disconnector switching operations. The transients generated during switching operations in GIS are associated with high frequency components in the order of few tens of MHz.

The main frequency with high voltage amplitude generated inside the 220/66kV Wadi-Hoof GIS due to the operation of disconnector (DS5) is 5 to 10 MHz, with the highest amplitude at 9 MHz. The main frequency with high voltage amplitude due to the operation of circuit breaker (CB5) is 1 to 25 MHz, with the highest amplitude at 2 MHz.

Mitigating techniques damped the oscillating frequencies effectively inside the 220/66kV Wadi-Hoof GIS. The using of cable terminal reduced the frequency oscillation effectively than that of OHL terminal. The using of a shunt capacitance results in vanishing the high frequency components. Ferrite rings reduces the high frequency components effectively especially in the range 2 to 7 MHz. Also, the using of RC and RL filters results in vanishing the high frequency components.

## REFERENCES

- [1] A. J. Martinez, "Statistics Assessment of Very Fast Transient Overvoltages in Gas Insulated Substations", IEEE Power Engineering Society Summer Meeting 2000; 2: 882-883.
- [2] X. Dong, S. Rosado, Y. Liu, N. C. Wang, E. L. Line and T. Y. Guo, "Study of Abnormal Electrical Phenomena Effects on GSU Transformers", IEEE Transactions on Power Delivery July 2003; 18(3): 835.
- [3] A. Said, Ebrahim A. Badran and M.A. Abd-Allah, "Mitigation of Very Fast Transient Overvoltages at the More Sensitive Points in Gas Insulated Substation". International Journal of Electrical and Power Engineering, 6(3): 118-123, 2012.
- [4] V. Vinod Kumar, M. Joy Thomas, and M. S. Naidu, "Influence of Switching Conditions on the VFTO Magnitudes in a GIS", IEEE Transaction on Power Delivery, VOL. 16, NO. 4, 2001.
- [5] M. Mohana Rao, M. Joy Thomas, and B. P. Singh, "Electromagnetic Field Emission From Gas-to-Air Bushing in a GIS During Switching Operations", IEEE Transactions on Electromagnetic Compatibility, VOL. 49, NO. 2, 2007.
- [6] M. Mohana Rao, M. Joy Thomas and B.P. Singh, "Frequency spectrum analysis of fast transient currents (FTC) due to switching operations in a 245 kV GIS", Asia Pacific. IEEE/PES, Transmission and Distribution Conference and Exhibition, 2239-2243, vol.3, 6-10 Oct. 2002.
- [7] Wan Yiru, Chen Guang and Zhou Hao, "Study on VFTO in UHV GIS Substation" 4th International Conference on Electric Utility Deregulation and Restructuring and Power Technologies (DRPT), 2011.
- [8] Ahmad Tavakoli, Ahmad Gholami, "Influence of Terminal Components for Suppression of High-Frequency Transients in GIS", International Power and Energy Conference (IPEC 2010), Singapore, 27-29 Oct. 2010.
- [9] Fan Li-ping and Liang Yu, "The Effect of Apparatus Model on Very Fast Transient Over-voltage", International Conference on Electric Information and Control Engineering (ICEICE), 15-17 April, 2011.
- [10] L. Qingmin and W Minglei, "Simulation Method for the Applications of Ferromagnetic Materials in Suppressing High Frequency Transients Within GIS". IEEE Transactions on Power Delivery July 2007; 22(3): 1628.
- [11] Mariusz Stosur, Marcin Szewczyk, Wojciech Piasecki, Marek Florkowski and Marek Fulczyk, "GIS Disconnector Switching Operation- VFTO Study", Modern Electric Power Systems 2010, MEPS'10 - paper 13.4, Wroclaw, Poland.
- [12] J. V. G. Rama Rao, J. Amarnath and S. Kamakshiah, "Accurate Modeling of Very Fast Transients Overvoltages in A 245kV GIS and Research on Protection Measures", IEEE International conference on Electrical Insulation and Dielectric phenomena (CEIDP2010), West Lafayette, USA.
- [13] Wang Zhuo, Wang Wei-quan and Wang Qiang, "Research of Suppressing VFTO for 500kV GIS Substation Based on EMTP/ATP",



International Conference on E -Business and E -Government (ICEE), 6-8 May 2011.

- [14] J. V. G. Rama Rao, J. Amarnath and S. Kamakshiah, " Time-Frequency Analysis Of Very Fast Transient Over Voltages For Effective Shielding Of Control Circuits In A 245kv Gas Insulated Substation", International conference on High Voltage Engineering and Application (ICHVE), 11-14 Oct, 2010.



**Mousa A. Abd-Allah** was born in Cairo, Egypt, on August 16, 1961. He received the B.Sc. degree in electrical Engineering with honor in 1984 and the M.Sc. degree in High Voltage Engineering in 1988, both from Zagazig university, benha branch, Cairo, Egypt. He received the Ph.D. degree in High Voltage Engineering in 1992 from Cairo University. He is currently a professor with the Electrical Engineering department, Faculty of Engineering at Shoubra, Benha

University. His research activity includes Electromagnetic Field Assessment and Mitigation around Electrical Equipments, Gas discharge in gas insulated systems, Electromagnetic Compatibility, Transient Phenomenon in Power Networks.



**A. Said** was born in Cairo, Egypt, on March 9, 1987. He received the B.Sc. degree in electrical engineering with honor degree in 2009. and the M.Sc. degree in High voltage engineering in 2013, both from Faculty of Engineering at Shoubra, Benha University, Cairo, Egypt. On Augst 2010, he received his work in this faculty as an instructor in the Electrical Engineering Department. Currently he is assist lecture and PHD researcher in high voltage engineering. His research

activity includes studying the transiant in all components of GIS, factor affecting on VFTO, mitigation method of VFTO and renewable energy.



**Ebrahim A. Badran** was born in Fareskor, Damietta, Egypt, on january 10, 1969. He received the B.Sc. degree in electrical Engineering with honor in 1991 and the M.Sc. degree in Electrical power and machines in 1995, both from Mansoura university, , Cairo, Egypt. He received the Ph.D. degree in Electrical power and machines in 2004 from Mansoura university. He is currently a Lecturer with

The Electrical Engineering Department, Mansoura University and IEEE member. His research activity includes studying the transiant in all component of GIS, factor affecting on VFTO, mitigation method of VFTO. Transformer modeling, ferro resonance, Electrical drives.