

# Generalized d-q Model of n-Phase Induction Motor Drive

G. Renukadevi, K. Rajambal

**Abstract**—This paper presents a generalized d-q model of n-phase induction motor drive. Multi -phase (n-phase) induction motor (more than three phases) drives possess several advantages over conventional three-phase drives, such as reduced current/phase without increasing voltage/phase, lower torque pulsation, higher torque density, fault tolerance, stability, high efficiency and lower current ripple. When the number of phases increases, it is also possible to increase the power in the same frame. In this paper, a generalized  $dq$ -axis model is developed in Matlab/Simulink for an n-phase induction motor. The simulation results are presented for 5, 6, 7, 9 and 12 phase induction motor under varying load conditions. Transient response of the multi-phase induction motors are given for different number of phases. Fault tolerant feature is also analyzed for 5-phase induction motor drive.

**Keywords**— $d-q$  model, dynamic Response, fault tolerant feature, Matlab/Simulink, multi-phase induction motor, transient response.

## I. INTRODUCTION

THREE phase induction motors have well known advantages of simple construction, reliability, ruggedness, low maintenance and low cost which has led to their wide spread use in many industrial applications [1]-[3]. More published work has shown that drives with more than three phases have various advantages over conventional three-phase ones, such as lower torque pulsation, reduction in harmonic currents, reduced current per phase without the need to increase the phase voltage, greater reliability and fault tolerant feature [4]-[17]. The n-phase induction machines are normally applied for high power applications such as ship propulsion, electric aircraft, and electric/hybrid electric vehicles etc. General theory of electric machines provides sufficient means for dealing with mathematical representation of an induction machine with an arbitrary number of phases on both stator and rotor. It can also effectively model machines with sinusoidally distributed windings and with concentrated windings, where one has to account for the higher spatial harmonics of the magneto-motive force. Probably the most comprehensive treatment of the modeling procedure at a general level is available in [3]. In the developing phases, the winding displacements required, however, are not necessary the symmetrical displacements used in standard multiphase machines. The derivation of the voltage equations in phase

variables and the transformation to the  $d-q-o$  reference frame of a multi-phase machine with unsymmetrical phase displacement has been reported in [18]. In high-power drives, for example, machines with two groups of insulated coils that are 30 degrees out of phase and separately-powered have long been used successfully and discusses the current source inverter fed six phase induction machine [19]. A physical variable model of a multi-phase machine is obtained in [20]. This paper focuses on the development of flexible simulation model of generalized n-Phase machine model of induction motor. More recently, detailed modeling of an n-phase induction machine, including the higher spatial harmonics, of a five-phase induction machine has been investigated in detail in [21]-[24]. It contains the transformations of the phase-variable model are performed using appropriate real or complex matrix transformations, resulting in corresponding real or space vector models of the multiphase machine. A slightly different approach to the multiphase machine modeling is discussed in [25], [26]. It is termed 'vectorial modeling' and it represents a kind of generalization of the space vector theory, applicable to all types of AC machines. In [27] discusses the performance of the stator winding layouts for various phase numbers, as well as a discussion of space harmonics of the magneto motive force (MMF). A survey of control schemes for asymmetrical six-phase induction motor drives and associated methods of VSI PWM control is given in [28]. Detailed modeling approach is discussed in [29]. It contains basic models, control schemes in developed form, and experimentally obtained illustrations of performance for various multiphase induction motor drives (asymmetrical and symmetrical six-phase, and five-phase machines). The multiphase machine designs, various control schemes and different PWM methods are addressed in [30]. The design of post fault operating strategies and for multimotor multiphase drives with single inverter supply has been covered and also discusses the potential of multiphase machines for electric-energy generation is briefly addressed. Modeling of the machines leads to an insight into the electro-mechanical and electrical transients. Generalized  $d-q$  models for machines with high number of phases are generally not available in commonly used simulation packages. This paper focuses on the development of flexible simulation model of generalized n-phase machine model of induction motor, a simple approach of utilizing the built in blocks of Matlab/Simulink environment. An attempt is made in this paper for various simulation results are obtained for n-phase induction machines are run at different load conditions with the help of different parameters.

G.Renukadevi is with the Department of Electrical and Electronics Engineering, Pondicherry Engineering College, Pondicherry, India (e-mail: renukadeviayappan@gmail.com).

K. Rajambal is with the Department of Electrical and Electronics Engineering, Pondicherry Engineering college, Pondicherry, India (e-mail: rajambalk@pec.edu).

## II. GENERALIZED D-Q MODEL OF MULTI-PHASE INDUCTION MOTOR DRIVE

The well-known space vector and  $d$ - $q$  models of three-phase machines are only particular cases of the universal  $n$ -phase machine models. Since the phase-variable model of a physical multiphase machine gets transformed using a mathematical transformation, the number of variables before and after transformation must remain the same. This means that  $n$ -phase machine will have  $n$  new stator current (stator voltage, stator flux) components after the transformation. An  $n$ -phase symmetrical induction machine, such that the spatial displacement between any two consecutive stator phases equals  $\alpha=2\pi/n$ , is considered. It is assumed that the windings are sinusoidally distributed, so that all higher spatial harmonics of the magneto-motive force can be neglected. The phase number  $n$  can be either odd or even. It is assumed that, regardless of the phase number, windings are connected in star with a single neutral point. The machine model in original form is transformed using decoupling (Clarke's) transformation matrix [3], which replaces the original sets of  $n$  variables with new sets of  $n$  variables. Decoupling transformation matrix for an arbitrary phase number  $n$  can be given in power invariant real or complex matrix transformations, resulting in corresponding real or space vector models of the sign multiphase machine. Decoupling transformation matrix for an arbitrary phase number  $n$  can be given in power invariant form shown in (1), where  $\alpha=2\pi/n$ . The first two rows of the matrix define variables that will lead to fundamental flux and torque production ( $\alpha$ - $\beta$  components; stator to rotor coupling appears only in the equations for  $\alpha$ - $\beta$  components). The last two rows define the two zero sequence components are omitted for all odd phase numbers  $n$ . In between, there are  $x$ - $y$  components.

$$\begin{bmatrix} v_q \\ v_d \\ v_x \\ v_y \\ \vdots \\ \vdots \\ 0_+ \\ 0_- \end{bmatrix} = \sqrt{\frac{2}{n}} \begin{bmatrix} 1 & \cos\alpha & \cos2\alpha & \cos3\alpha & \dots & \cos n\alpha \\ 0 & \sin\alpha & \sin2\alpha & \sin3\alpha & \dots & \sin n\alpha \\ 1 & \cos2\alpha & \cos4\alpha & \cos6\alpha & \dots & \cos n\alpha \\ 0 & \sin2\alpha & \sin4\alpha & \sin6\alpha & \dots & \sin n\alpha \\ \frac{1}{\sqrt{2}} & \frac{1}{\sqrt{2}} & \frac{1}{\sqrt{2}} & \frac{1}{\sqrt{2}} & \dots & \frac{1}{\sqrt{2}} \\ \frac{1}{\sqrt{2}} & \frac{1}{\sqrt{2}} & \frac{1}{\sqrt{2}} & \frac{1}{\sqrt{2}} & \dots & \frac{1}{\sqrt{2}} \end{bmatrix} \begin{bmatrix} v_a \\ v_b \\ v_c \\ v_d \\ v_e \\ v_f \\ \vdots \\ \vdots \\ v_n \end{bmatrix} \quad (1)$$

Equations for pairs of  $x$ - $y$  components are completely decoupled from all the other components and stator to rotor coupling does not appear either [3]. These components do not contribute to torque production when sinusoidal distribution of the flux around the air-gap is assumed. A zero-sequence component does not exist in any star-connected multiphase system without neutral conductor for odd phase numbers,

while only zero components can exist if the phase number is even. Since rotor winding is short-circuited, neither  $x$ - $y$  nor zero-sequence components can exist, nor needs one only to consider further on  $\alpha$ - $\beta$  equations of the rotor winding. As stator to rotor coupling takes place only in  $\alpha$ - $\beta$  equations, rotational transformation is applied only to these two pairs of equations. Its form is similar to a three-phase machine. Assuming that the machine equations are transformed into an arbitrary frame of reference rotating at angular speed  $\omega_e$ , the model of an  $n$ -phase induction machine with sinusoidal winding distribution is given with

Stator circuit equations:

$$v_{ds} = R_s i_{ds} + \frac{d}{dt} \psi_{ds} - \omega_e \psi_{qs} \quad (2)$$

$$v_{qs} = R_s i_{qs} + \frac{d}{dt} \psi_{qs} + \omega_e \psi_{ds} \quad (3)$$

Rotor circuit equations:

$$v_{dr} = R_r i_{dr} + \frac{d}{dt} \psi_{dr} - (\omega_e - \omega_r) \psi_{qr} \quad (4)$$

$$v_{qr} = R_r i_{qr} + \frac{d}{dt} \psi_{qr} + (\omega_e - \omega_r) \psi_{dr} \quad (5)$$

Flux linkage expressions in terms of the currents are

$$\psi_{ds} = L_{ls} i_{ds} + L_m (i_{ds} + i_{dr}) \quad (6)$$

$$\psi_{dr} = L_{lr} i_{dr} + L_m (i_{ds} + i_{dr}) \quad (7)$$

$$\psi_{qs} = L_{ls} i_{qs} + L_m (i_{qs} + i_{qr}) \quad (8)$$

$$\psi_{qr} = L_{lr} i_{qr} + L_m (i_{qs} + i_{qr}) \quad (9)$$

$$\psi_{dm} = L_m (i_{ds} + i_{dr}) \quad (10)$$

$$\psi_{qm} = L_m (i_{qs} + i_{qr}) \quad (11)$$

$$i_{ds} = \frac{\psi_{ds} (L_{lr} + L_m) - L_m \psi_{dr}}{(L_{ls} L_{lr} + L_{ls} L_m + L_{lr} L_m)} \quad (12)$$

$$i_{qs} = \frac{\psi_{qs} (L_{lr} + L_m) - L_m \psi_{qr}}{(L_{ls} L_{lr} + L_{ls} L_m + L_{lr} L_m)} \quad (13)$$

$$i_{dr} = \frac{\psi_{dr} (L_{ls} + L_m) - L_m \psi_{ds}}{(L_{ls} L_{lr} + L_{ls} L_m + L_{lr} L_m)} \quad (14)$$

$$i_{qr} = \frac{\psi_{qr}(L_{ls} + L_m) - L_m \psi_{qs}}{(L_{ls}L_{lr} + L_{ls}L_m + L_{lr}L_m)} \quad (15)$$

$$w_r = \int \frac{P}{2J} (T_e - T_L) dt \quad (17)$$

where  $L_m = (n/2) M$  and  $M$  is the maximum value of the stator to rotor mutual inductances in the phase-variable model.

$$T_e = PL_m (i_{qs} i_{dr} - i_{ds} i_{qr}) \quad (16)$$

Model equations for  $d-q$  components in (1)-(14), torque equation (15) and speed equation (16) are identical for a three-phase induction motor. In principle, the same control schemes will apply to multiphase induction motors as for three-phase motors.

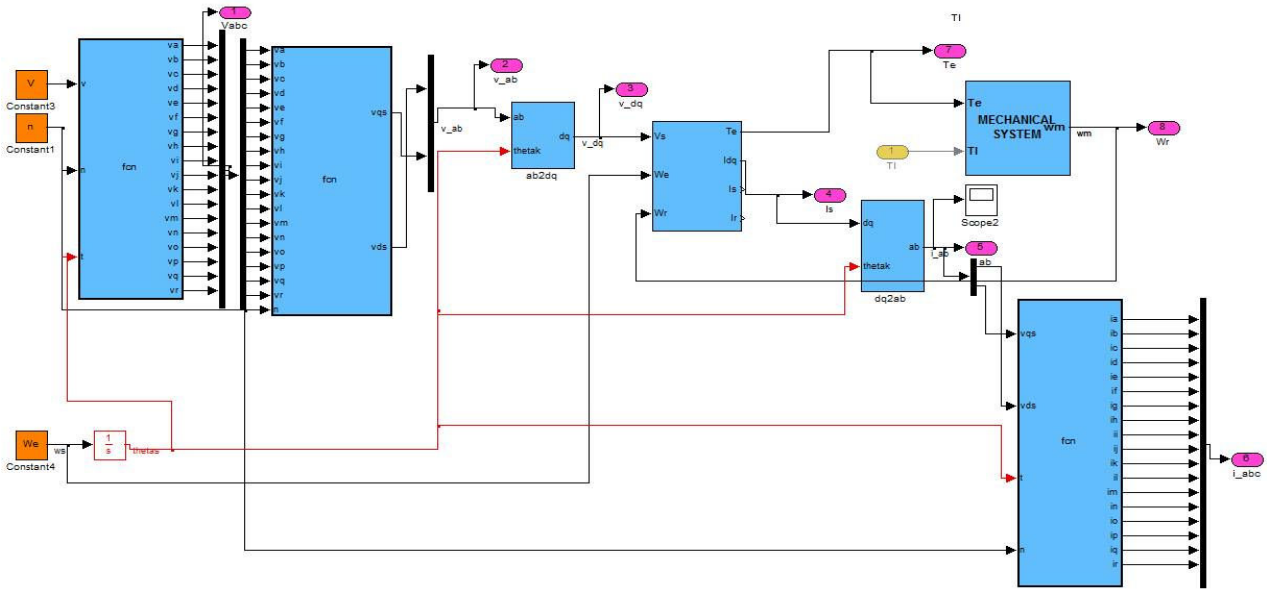

Fig. 1 Simulink model of multi-phase induction motor

### III. $d-q$ MODELING OF MULTI-PHASE INDUCTION MOTOR USING MATLAB/SIMULINK

The mathematical equations presented in (1)-(17) are used to model the multiphase induction motor in Matlab/Simulink environment. Fig. 1 shows the Simulink model of the multi-phase drive. The stator voltage ( $v$ ) and number of phases ( $n$ ) are the inputs to the model. The speed, torque, stator current is observed for different number of phases and the results are discussed in detail in the following section.

### IV. SIMULATION RESULTS

The simulation model is developed in a Matlab/Simulink environment. The simulation parameters for  $n$ -phase induction motors are shown in Table I. The results are observed for induction motors with 5, 6, 7, 9, and 12 phases under different loading conditions. The load torque is varied in steps and the corresponding variations in stator current, torque, and speed are observed and shown in Fig. 2 for different number of phases. Fig. 2 (a) shows the response of 5-phase induction motor. At  $t=0$ , motor is no loaded and the load is varied in steps as 25%, 50%, 75%, and full load at every 1sec respectively. It is seen that the stator current increases and speed decreases with increasing load and the motor torque follows the load torque. Simulation is repeated for 6, 7, 9, and

12 phase induction motors. Figs. 2 (b) to 4 (e) show the result of 6, 7, 9, and 12 phase induction motors respectively for the same step load conditions. It is seen that the developed generalized model performs efficiently for the given number of phases and can be extended for number of phases more than 12. The transient oscillations of torque and speed for a load change from no load to rated torque condition is observed and shown in Figs. 3 to 7. In Fig. 3 the peak overshoot is 2.5 times of rated torque and the torque oscillation exists for about 0.05secs of 5 phase drive. Fig. 4 shows the 6 phase results, the peak overshoot is 2.6 times of rated torque and the torque oscillation exists for about 0.05secs. In Fig. 5 the peak overshoot is 2.3 times of rated torque and the torque oscillation exists for about 0.04secs of 7 phase induction motor. Simulation is repeated for 9 and 12 phase induction motors. From the observation the peak overshoot is 2.3 times of rated torque and the torque oscillation exists for about 0.05secs of 9 phase drive as shown in Fig. 6. In the 12 phase induction motor peak overshoot is 1.8 times of rated torque and the torque oscillation exists for about 0.04secs as shown in Fig. 7. Fault tolerant feature of the 5-phase induction motor is observed from 1<sup>st</sup> and 1<sup>st</sup> and 5<sup>th</sup> stator windings opened condition is shown in Figs. 8 and 9. It is seen that the number of lost phase increases, the starting current of the rest of the phases increases and rated torque decreases gradually.

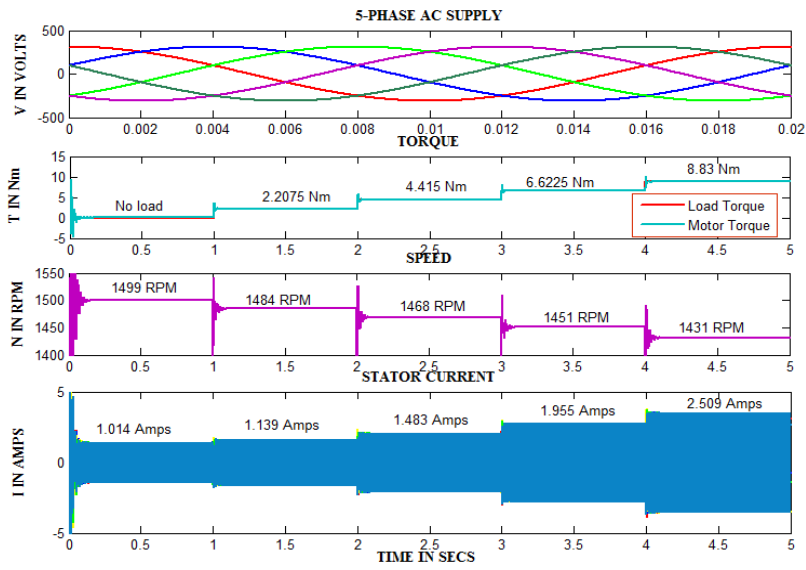

Fig. 2 (a) Simulation results for 5-phase machine at different load conditions

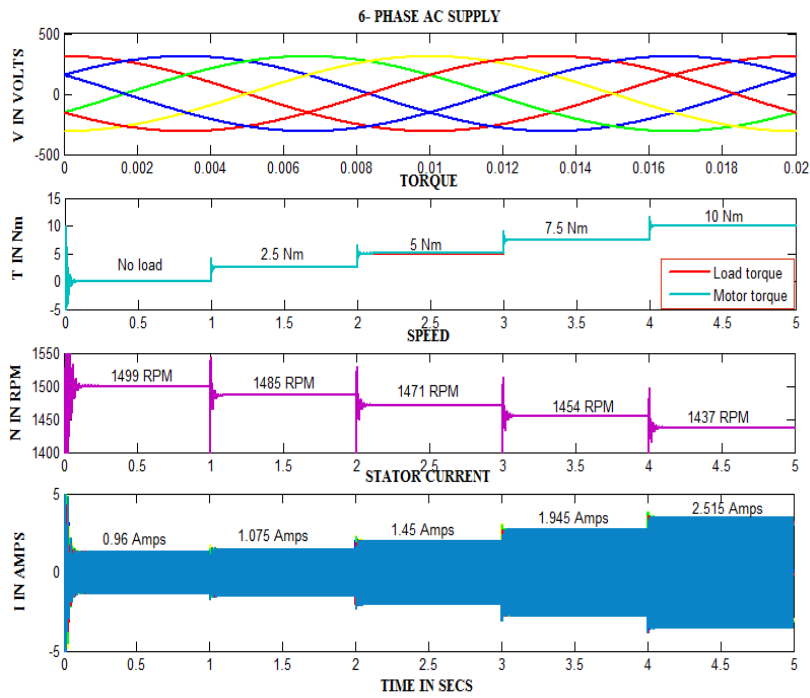

Fig. 2 (b) Simulation results for 6-phase machine at different load conditions

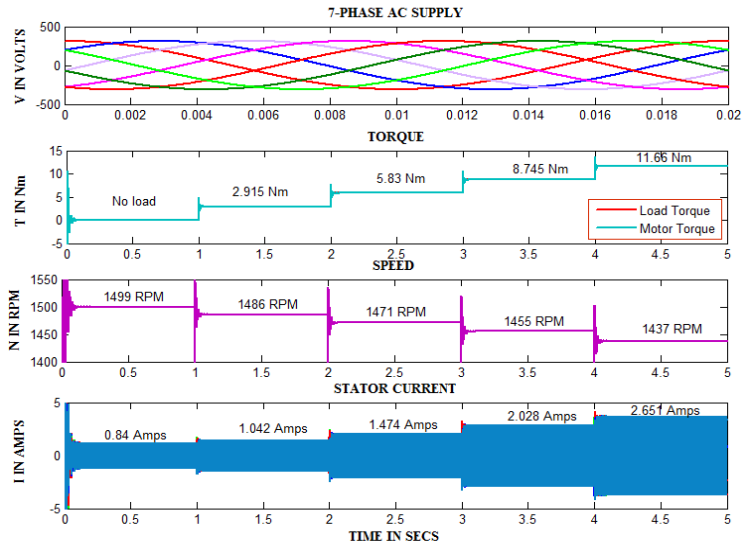

Fig. 2 (c) Simulation results for 7-phase machine at different load conditions

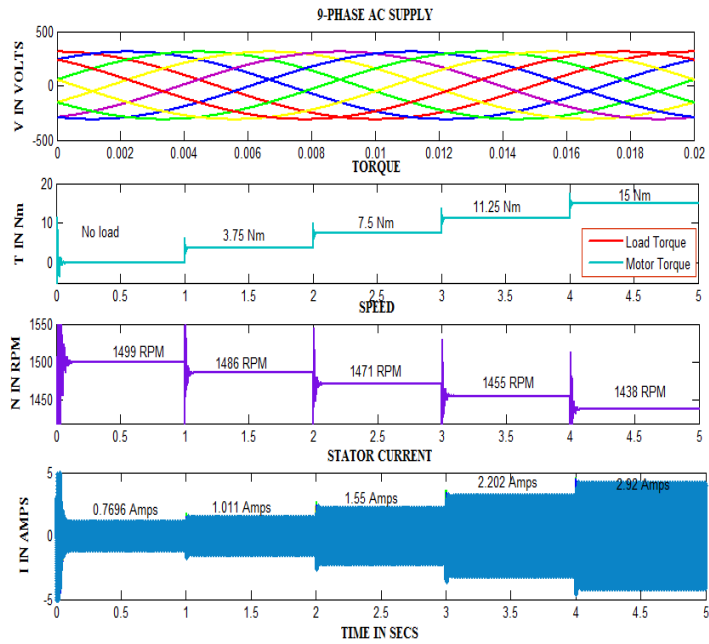

Fig. 2 (d) Simulation results for 9-phase machine at different load conditions

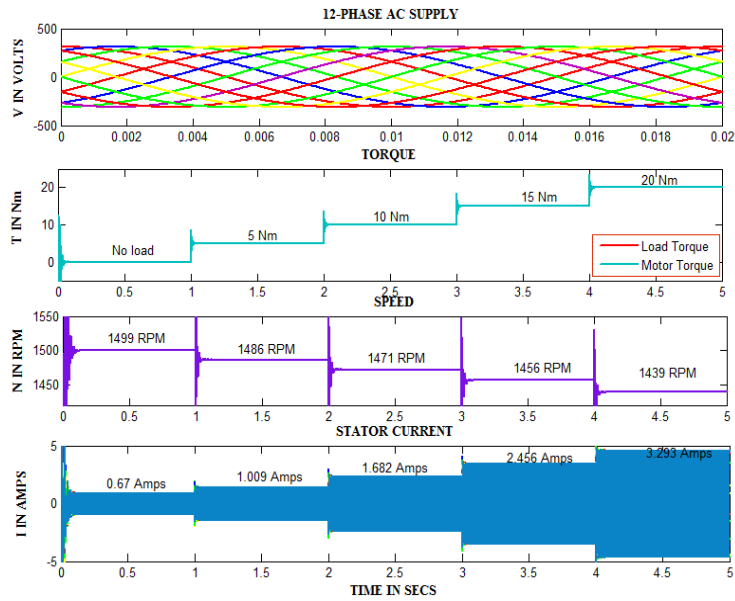

Fig. 2 (e) Simulation results for 12-phase machine at different load conditions

Fig. 2 Dynamic response of the different multi-phase induction motor under varying load conditions

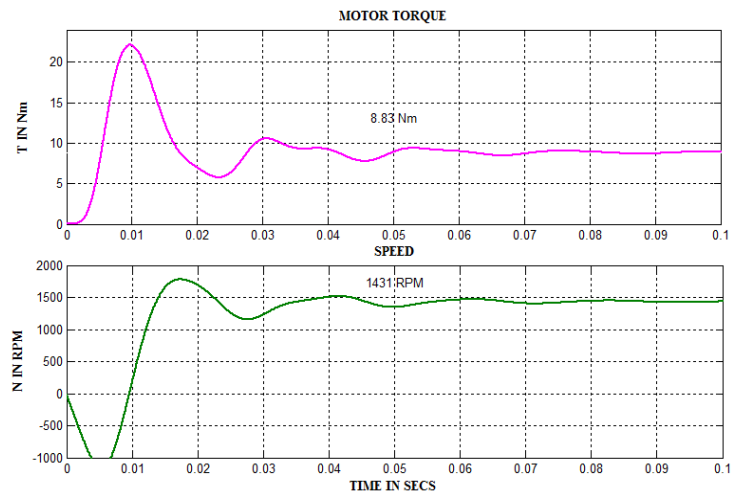

Fig. 3 Transient response of speed and torque at  $t=0.05$ sec for 5-phase induction motor drive

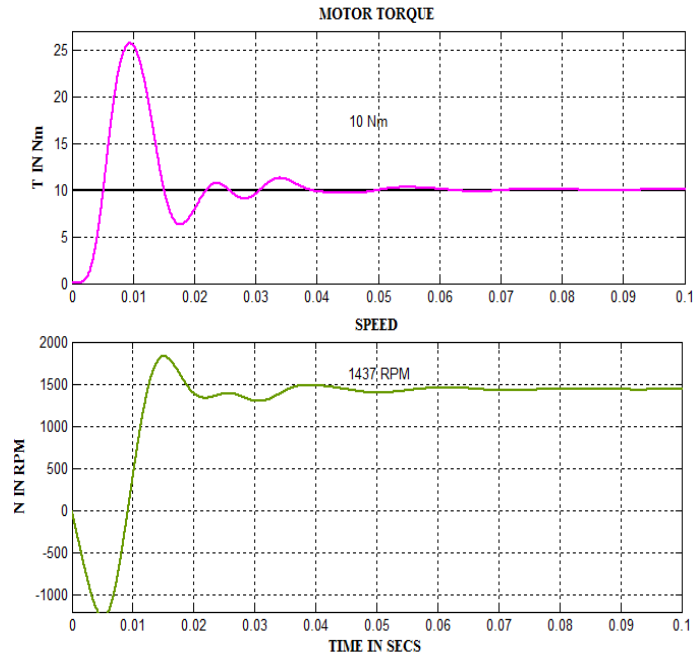

Fig. 4 Transient response of speed and torque at  $t=0.05$ sec for 6-phase induction motor drive

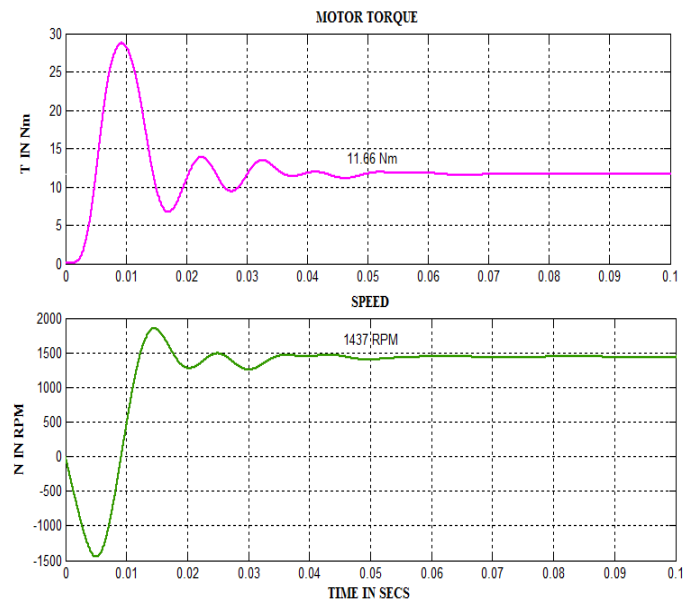

Fig. 5 Transient response of speed and torque at  $t=0.04$ sec for 7-phase induction motor drive

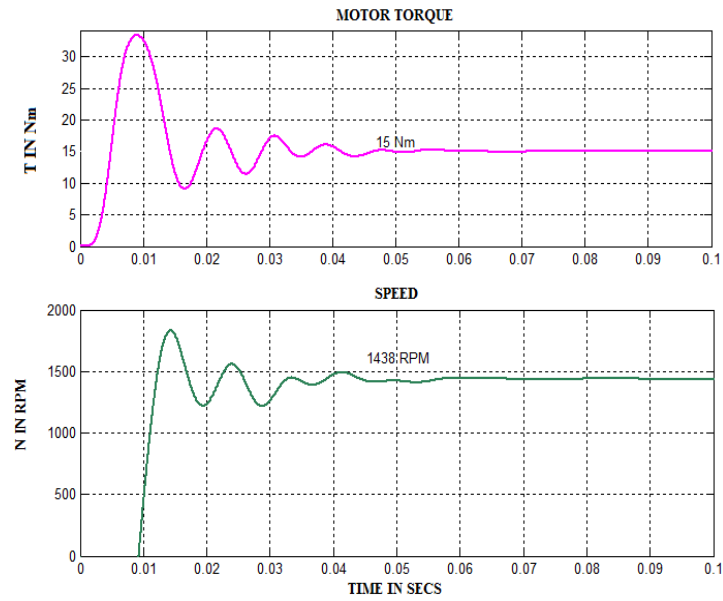

Fig. 6 Transient response of speed and torque at  $t=0.05$ sec for 9-phase induction motor drive

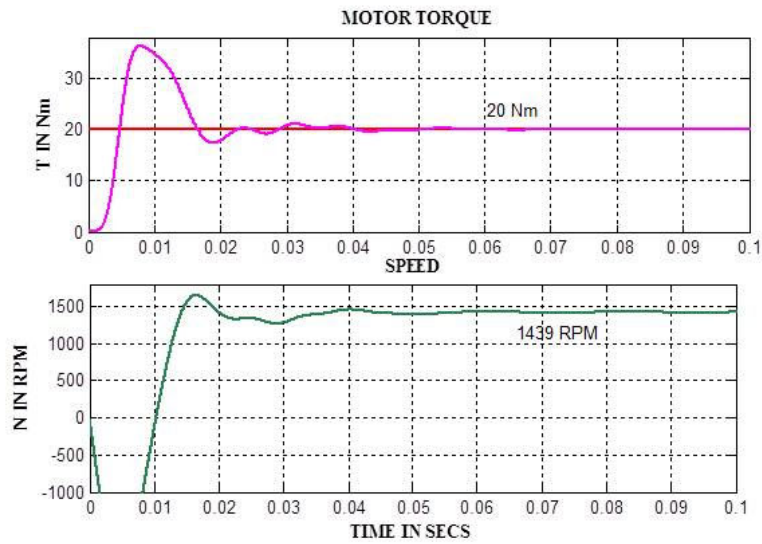

Fig. 7 Transient response of speed and torque at  $t=0.04$ sec for 12-phase induction motor drive



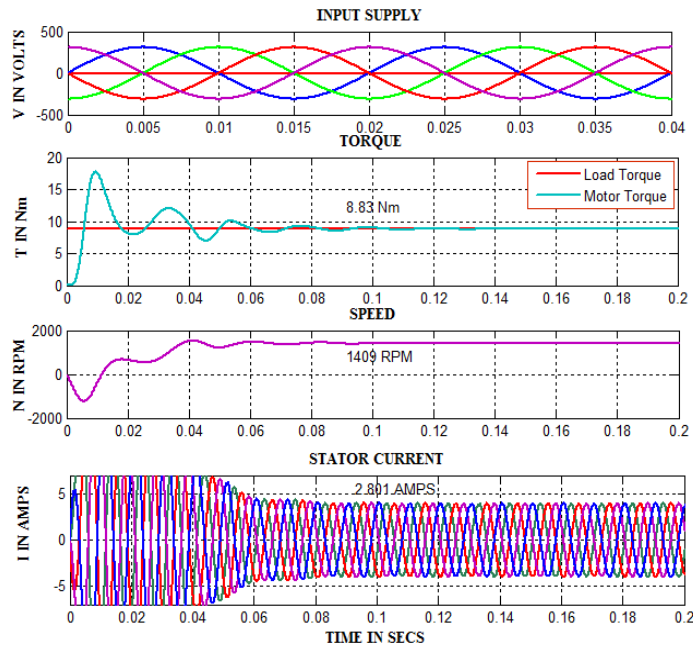

Fig. 8 Fault tolerant results of 5-phase induction motor with one (1<sup>st</sup>) of the phase is opened

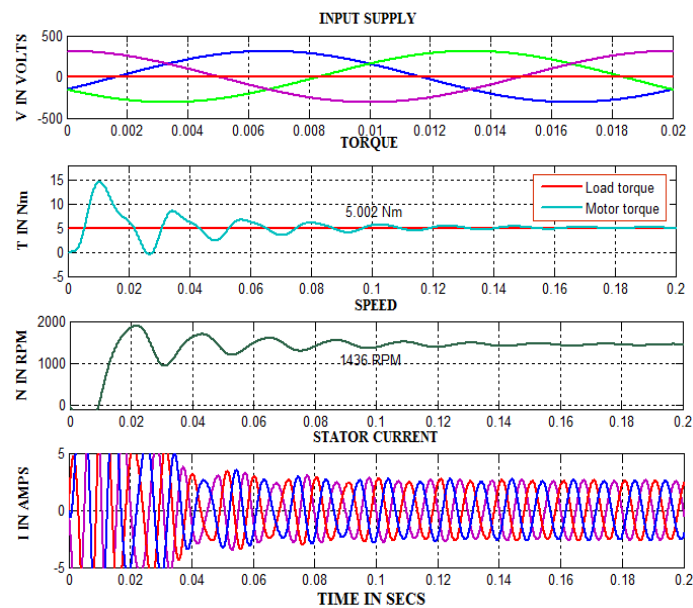

Fig. 9 Fault tolerant simulation results of 5-phase induction motor with two (1<sup>st</sup> and 5<sup>th</sup>) of the phases are opened

V.CONCLUSION

This paper presents a generalized model of *n*-phase induction motor drive. The model is based on the *d-q* axis equivalent circuit. The simulation model is developed using simpower system block set of the Matlab/Simulink software. The comprehensive model of the *n*-phase induction motor is simulated under different load conditions. The model is simulated to study the steady-state and dynamic behavior of the multi-phase induction motor. The simulation results are

presented for 5, 6, 7, 9 and 12 phases under varying load conditions. The transients during step load changes are observed. The model performs effectively for different number of phases and can be extended for phases more than 12. The fault tolerant simulation results show, with the additional degrees freedom of multiphase structure, the 5-phase induction motor is able to start and run even lost one or two stator windings.

TABLE I  
PARAMETERS OF THE THREE PHASE INDUCTION MOTOR

Parameters	Values
Power	1 hp
Voltage	220 V
Phase	n-phase
Frequency	50 Hz
No. of poles	4
Stator resistance (Rs)	10 ohm
Rotor resistance (Rr)	6.3 ohm
Stator inductance (Ls)	0.04 mH
Rotor inductance (Lr)	0.04 mH
Mutual inductance (Lm)	0.42 mH
Inertia (J)	0.03 kg.m <sup>2</sup>
Friction (F)	0.0015N.m.s

## NOMENCLATURE

B	Friction coefficient
J	Moment of inertia
L <sub>ls</sub>	Stator leakage inductance
L <sub>lr</sub>	Rotor leakage inductance
n	Number of phases
M	Mutual inductance between stator and rotor
P	Number of poles
R <sub>s</sub>	Stator resistance
R <sub>r</sub>	Rotor resistance
$\alpha$	Angular displacement between stator and rotor
T <sub>e</sub>	Electromagnetic torque
T	Load torque
$\omega_e$	Rotor speed in electrical degrees
$\omega_m$	Rotor speed in mechanical degrees
$\theta$	Stator coordinate in electrical degrees
$\Psi$	Flux linkage
d	Direct axis
q	Quadrature axis
V <sub>ds</sub> , V <sub>qs</sub>	d & q axis stator voltages
V <sub>dr</sub> , V <sub>qr</sub>	d & q axis rotor voltages
I <sub>ds</sub> , I <sub>qs</sub>	d & q axis stator currents
I <sub>dr</sub> , I <sub>qr</sub>	d & q axis rotor currents

## REFERENCES

- [1] D. Novotny, and T.A. Lipo, *Vector control and dynamics of ac drives*, Clarendon Press, Oxford, UK, 2000.
- [2] Bimal K. Bose, *Modern power electronics and ac drives*, Prentice Hall 2002.
- [3] D.C. White and H.H. Woodson, *New Electromechanical energy conversion*, John Wiley and Sons, New York, 1957.
- [4] E.E. Ward and H. Harer, "Preliminary investigation of an inverter fed five-phase induction motor", *Proc. IEE* 116 (6), 1969, pp. 980-984.
- [5] T.M. Jahns, "Improved reliability in solid-state AC drives by means of multiple independent phase-drive units", *IEEE Transactions on Industry Applications*, vol. IA-16, no. 3, may.-jun.1980, pp. 321-331.
- [6] S. Williamson and A.C. Smith, "Pulsating torque and losses in multiphase induction machines", *IEEE Trans. Ind. Appl.*, vol. 39, no. 4, pp. 986-993, July/Aug. 2003.
- [7] M. A. Abbas, R. Christen, and T. M. Jahns, "Six-phase voltage source inverter driven induction motor," *IEEE Trans. Ind. Applicat.*, vol. IA-20, no. 5, pp. 1251-1259, Sept./Oct. 1984.
- [8] R. Lyra and T. A. Lipo, "Torque density improvement in a six-phase induction motor with third harmonic current injection", *IEEE Trans. Ind. Appl.* Vol. 38, no. 5, pp. 1351-1360, Sept./Oct. 2002.
- [9] M. Apsley and Williamson, "Analysis of multi-phase inductions with winding faults", *Proc. IEEE IEMDC*, San Antonio, TX, pp.249-255, 2005.
- [10] J.M. Apsley, S. Williamson, A.C. Smith and M. Barnes, "Induction motor performance as a function of phase number", *Proc. Int. Electr. Eng.-Electr. Power Appl.*, vol. 153, no. 6, pp. 898-904, Nov. 2006.
- [11] Boglietti, R. Bojoi, A. Cavagnino, and A. Tenconi, "Efficiency analysis of PWM inverter fed three-phase and dual three-phase induction machines," in *Conf. Rec. IEEE IAS Annu. Meeting*, Tampa, FL, 2006, pp. 434-440.
- [12] D. Dujic, M. Jones, and E. Levi, "Analysis of output current ripple rms in multiphase drives using space vector approach", *IEEE Trans. On Power Elect.*, vol. 24, no. 8, pp. 1926-1938, Aug. 2009.
- [13] A. Toliyat, T.A. Lipo and J.C. White, "Analysis of concentrated winding machine for adjustable speed drive applications-Part II: Motor design performance", *IEEE Trans. Energy Convers.*, vol. 6, no. 4, pp. 684-692, Dec. 1991.
- [14] Y. Zhao and T. A. Lipo, "Modeling and control of a multi-phase induction machine with structural unbalance. Part I: Machine modeling and multi-dimensional current regulation," *IEEE Trans. Energy Convers.*, vol. 11, no. 3, pp. 570-577, Sep. 1996.
- [15] Y. Zhao and T. A. Lipo, "Modeling and control of a multi-phase induction machine with structural unbalance. Part II: Field-oriented control and experimental verification," *IEEE Trans. Energy Convers.*, vol. 11, no. 3, pp. 578-584, Sep. 1996.
- [16] E. A. Klingshirn, "High phase order induction motors—Part I—Description and theoretical considerations," *IEEE Trans. Power App. Syst.*, vol. PAS-102, no. 1, pp. 47-53, Jan. 1983.
- [17] E. A. Klingshirn, "High phase order induction motors—Part II—Experimental results," *IEEE Trans. Power App. Syst.*, vol. PAS-102, no. 1, pp. 54-59, Jan. 1983.
- [18] R. H. Nelson and P. C. Krause, "Induction machine analysis for arbitrary displacement between multiple winding sets," *IEEE Trans. Power App. Syst.*, vol. PAS-93, no. 3, pp. 841-848, May 1974.
- [19] T. A. Lipo, "A d-q model for six phase induction machines," in *Proc. Int. Conf. Electrical Machines (ICEM)*, Athens, Greece, 1980, pp. 860-867.
- [20] Wang, S. C. Foroosh, J. Jatskevich, and A. Davoudi, "Physical variable modeling of multi-phase induction machines," *Canadian Conference on Electrical and Computer Engineering CCECE*, pp. 999-1004, Niagara Falls, Canada, 2008.
- [21] N. Golubev and V. V. Zykov, "Asynchronous motor with multiphase stator and rotor windings," *Russ. Electr. Eng.*, vol. 74, no. 7, pp. 43-51, 2003.
- [22] Pereira, L.A., Scharlau, C.C., Pereira, L.F.A., and Haffner, J.F.: 'Model of a five-phase induction machine allowing for harmonics in the air-gap field, Part I: Parameter determination and general equations'. *Proc. IEEE Industrial Electronics Society Annual Meeting IECON*. Busan, Korea, 2004, CD-ROM paper WC3-6
- [23] Pereira, L.A., Scharlau, C.C., Pereira, L.F.A., and Haffner, J.F.: 'Model of a five-phase induction machine allowing for Harmonics in the air-gap field, Part II: Transformation of co-ordinates and d-q models'. *Proc. IEEE Industrial Electronics Society Annual Meeting IECON*. Busan, Korea, 2004, CD-ROM paper TD3-4
- [24] L. A. Pereira, C. C. Scharlau, L. F. A. Pereira, and J. F. Haffner, "General model of a five-phase induction machine allowing for harmonics in the air gap field," *IEEE Trans. Energy Convers.*, vol. 21, no. 4, pp. 891-899, Dec. 2006.
- [25] Kestelyn, X., Semail, E., and Hautier, J.P.: 'Vectorial multi- Machine modeling for a five-phase machine'. *Proc. Int. Conf. on Electrical Machines ICEM*. Bruges, Belgium, 2002, CD-ROM paper 394.
- [26] Semail, E., Bouscayrol, A., and Hautier, J.P.: 'Vectorial formalism for analysis and design of polyphase synchronous machines', *Eur.Phys. J. Appl. Phys.*, 2003, 22, (3), pp. 207-220.
- [27] G. K. Singh, "Multi-phase induction machine drive research - a survey," *Electric Power System Research*, vol. 61, pp. 139-147, 2002.
- [28] R. Bojoi, F. Farina, F. Profumo, and A. Tenconi, "Dual-three phase induction machine drives control—A survey," *IEEE Trans. Ind. Appl.*, vol. 126, no. 4, pp. 420-429, 2006.
- [29] E. Levi, R. Bojoi, F. Profumo, H. A. Toliyat and S. Williamson, "Multi-phase induction motor drives-A technology status review", *IET Electr. Power Appl.* vol. 1, no. 4, pp. 489-516, July 2007.
- [30] E. Levi, "Multi-phase Machines for Variable speed applications" *IEEE Trans. Ind. Elect.*, vol. 55, no. 5, pp. 1893-1909, May 2008.