

Fuzzy Logic Based Maximum Power Point Tracking Designed for 10kW Solar Photovoltaic System with Different Membership Functions

S. Karthika, K. Velayutham, P. Rathika, D. Devaraj

Abstract—The electric power supplied by a photovoltaic power generation systems depends on the solar irradiation and temperature. The PV system can supply the maximum power to the load at a particular operating point which is generally called as maximum power point (MPP), at which the entire PV system operates with maximum efficiency and produces its maximum power. Hence, a Maximum power point tracking (MPPT) methods are used to maximize the PV array output power by tracking continuously the maximum power point. The proposed MPPT controller is designed for 10kW solar PV system installed at Cape Institute of Technology. This paper presents the fuzzy logic based MPPT algorithm. However, instead of one type of membership function, different structures of fuzzy membership functions are used in the FLC design. The proposed controller is combined with the system and the results are obtained for each membership functions in Matlab/Simulink environment. Simulation results are decided that which membership function is more suitable for this system.

Keywords—MPPT, DC-DC Converter, Fuzzy logic controller, Photovoltaic (PV) system.

I. INTRODUCTION

THE photovoltaic (PV) system technologies have increasing roles in electric power technologies, providing more secure power sources and pollution-free electric supplies [1]-[4]. Solar photovoltaic is a phenomenon where the solar irradiation is converted directly into electricity through solar cell [5]. The PV array can supply the maximum power to the load at a particular operating point which is generally called as maximum power point (MPP), at which the entire PV system operates with maximum efficiency and produces its maximum power.

A major challenge in the use of PV is posed by its nonlinear current-voltage (I-V) characteristics, which result in a unique maximum power point (MPP) on its power-voltage (P-V) curve. The high initial capital cost of a PV source and low energy conversion efficiency makes it imperative to operate the PV source at MPP so that maximum power can be extracted. The PV maximum output power is dependent on the operating conditions and varies from moment to moment due to temperature, irradiation and load so tracking and adjusting

for this maximum power point is a continuous process. In general, a power source is operated in conjunction with a dc power converter, whose duty cycle is modulated in order to track the instantaneous MPP of the PV source.

There are several methods and controllers that have been widely developed and implemented to track the MPP. In the last years researchers and practitioners in PV systems have presented survey or comparative analysis of MPPT techniques. The various MPPT techniques are Perturb and Observe (P&O) method [6]-[9], Incremental Conductance (IC) method [6]-[10], Artificial Neural Network method [11], Fuzzy Logic method [12], Constant Voltage [13], Three Point weight Comparison [14], short Current Pulse [15], Open Circuit Voltage [16], the temperature method [17]. The most commonly used methods are Perturb and Observe (P&O), incremental conductance and three-point weight comparison.

Among these, Perturb and Observe (P&O) method is dominantly used in practical PV systems for the MPPT control due to its simple implementation, high reliability, and tracking efficiency [5], [18], [19]. P&O technique applies perturbation to the buck-boost DC-DC controller by increasing or decreasing the voltage reference of the PWM (Pulse Width Modulation) signal, subsequently observes the effect on the PV output power. Problem that arises in P&O MPPT method is that the operating voltage in PV panel always fluctuating due to the needs of continuous tracking for the next perturbation cycle.

In this paper a fuzzy logic based MPPT technique is proposed. The fuzzy logic based MPPT can track the maximum power point faster and also it can minimize the voltage fluctuation after maximum power point has been recognized. The performance evaluation is done for different types of membership functions.

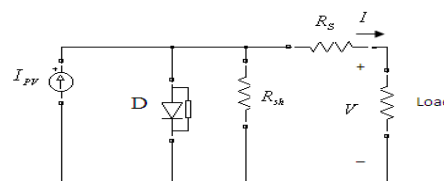

Fig. 1 Equivalent circuit of a solar cell

II. MATHEMATICAL MODEL OF PHOTOVOLTAIC MODULE

The general model of solar cell can be derived from physical characteristic of the diode, which is usually being

S. Karthika and P.Rathika are with the VV College of Engineering, Tisaiyanvilai, Tamil Nadu, India (e-mail: ns.karthika@yahoo.com, dr_p_rathika@yahoo.com).

K.Velayutham is with the Dr. Sivanthi Aditanar College of Engineering, Tiruchendur, Tamil Nadu, India (e-mail: velayutham4u@yahoo.co.in).

D. Devaraj is with the Kalasalingam University, Krishnankovil, Tamil Nadu, India (e-mail: deva230@yahoo.com).

called as one diode model. The equivalent circuit of solar cell is shown in Fig. 1 [20], [21]. Equation (1) shows the Shockley diode equation which describes the I-V Characteristic of diode D,

$$I_D = I_{sat} \left[\exp\left(\frac{V_D}{nV_T}\right) - 1 \right] \quad (1)$$

where I_D is the diode current, I_{sat} is the reverse bias saturation current, V_D is the voltage across the diode, n is the solar ideal factor of the diode and V_T is the thermal voltage.

Thermal voltage V_T however can be defined as

$$V_T = \frac{KT}{q} \quad (2)$$

where K is Boltzmann constant ($1.3806503 \times 10^{-23}$ J/K), T is temperature in degrees Kelvin and q is electron charge ($1.6021764 \times 10^{-19}$ C).

To model the I-V characteristic of PV array, (3) can be derived from the circuit shown in Fig. 1,

$$I = I_{pv} - I_0 \left[\exp\left(\frac{V + R_S I}{V_T a}\right) - 1 \right] - \frac{V + R_S I}{R_{sh}} \quad (3)$$

where I_{pv} is the light generated current, I_0 is the reverse saturation current, V is the PV array terminal voltage, R_S is the equivalent series resistance of the array and R_{sh} is the equivalent parallel resistance. In addition, the I-V characteristic of the PV panel is also depending on the internal characteristics such as the series resistance R_S and parallel resistance R_{sh} . The series resistance is the sum of structural resistance of PV panel and it has strong influence when PV panel act as voltage source. The parallel resistance R_{sh} has great influence when PV panel act as current source.

The light generated current of the photovoltaic cell depends linearly on the solar irradiation and is influenced by the temperature according to the following equation

$$I_{pv} = (I_{pv,n} + k_I \Delta_T) \frac{G}{G_n} \quad (4)$$

where $I_{pv,n}$ is the light-generated current at the nominal condition (usually 25°C and $1000\text{W}/\text{m}^2$), $\Delta_T = T - T_n$ (being T and T_n the actual and nominal temperatures [K]), $G[\text{W}/\text{m}^2]$ is the irradiation on the device surface, and G_n is the nominal irradiation.

The diode saturation current I_0 and its dependence on the temperature is given by,

$$I_0 = \frac{I_{sc,n} + K_I \Delta_T}{\exp\left(\frac{V_{oc,n} + K_V \Delta_T}{aV_T}\right) - 1} \quad (5)$$

where a is the diode ideality constant. K_V and K_I is the current and voltage coefficients. $I_{sc,n}$ and $V_{oc,n}$ are the nominal short circuit current and nominal open circuit voltage.

Figs. 2 and 3 show the I-V and P-V characteristics for the XL 6P54G200 PV module at 25°C and $1000\text{W}/\text{m}^2$. Table I shows the parameter of the XL 6P54G200 PV module.

Parameter	Value
Peak Power (W), PMPP	200
Peak Power Voltage (V), VMPP	27.16
Peak Power Current (A), IMPP	7.89
Open Circuit Voltage (V), Voc	33.64
Short Circuit Current (A), Isc	8.21
Temperature Coefficient of current (mA/ $^\circ\text{C}$), Ki	.003
Temperature Coefficient of voltage (mV/ $^\circ\text{C}$), Kv	-.123
Number of series cells, Ns	54

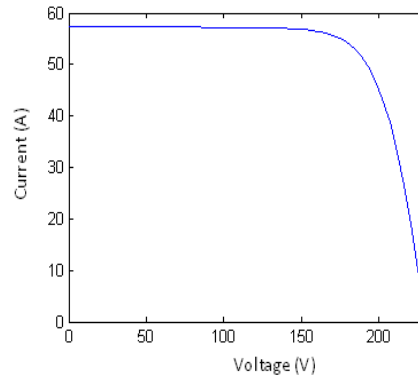

Fig. 2 I-V Characteristics of 10kW solar PV system

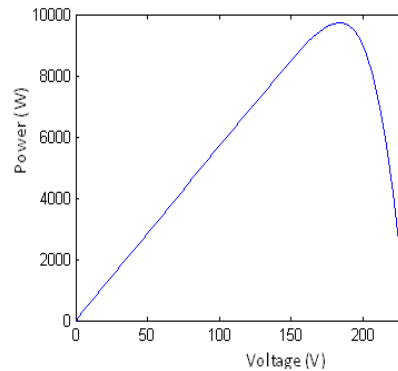

Fig. 3 P-V Characteristics of 10kW Solar PV System

The PV array contains seven series assemblies with seven series connected PV modules, each with 54 solar cells assemblies of XL 6P54G200 PV Modules. When the modules are wired in parallel, their current rating is increased while the voltage remains constant. When the modules are wired

together in series, their voltage is increased while the current remains constant. Hence, in this paper a fuzzy logic based MPPT technique is proposed. The fuzzy logic based MPPT can track the maximum power point faster and also it can minimize the voltage fluctuation after MPP has been recognized.

III. PROPOSED METHOD

The block diagram of the proposed solar PV system is shown in Fig. 4. It mainly consists of a PV Module, a buck-boost DC-DC converter, MPPT control unit and a load.

The PV panel contains 200 solar cells in series and 200 solar cells in parallel. When the modules are wired in parallel, their current rating is increased while the voltage remains constant. When the modules are wired together in series, their voltage is increased while the current remains constant. A pure

resistive load is connected to the PV module through the buck boost dc-dc converter.

The Photovoltaic module generates the DC voltage from solar temperature and irradiation. The energy supplied by the module does not have constant values, but fluctuates according to the surrounding condition such as intensity of solar rays and temperature. These supplies are therefore supplemented by additional converters. The DC to DC boost converter is used to regulate a chosen level of the solar photovoltaic module output voltage and to keep the system at the maximum power point. It is mainly useful for PV maximum power tracking purposes, where the objective is to draw maximum possible power from solar panels at all times, regardless of the load. It can able to regulate the perturbed voltage by increasing or decreasing the voltage reference of the PWM (Pulse width modulation) signal.

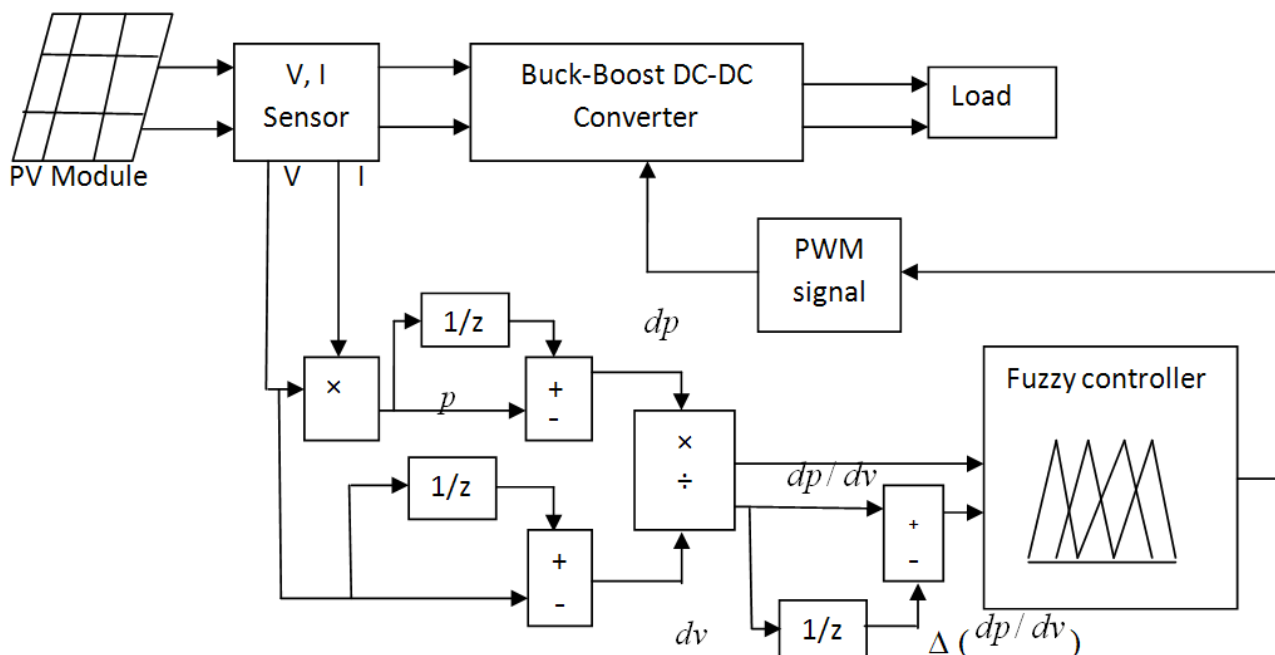

Fig. 4 Fuzzy logic based MPPT solar PV panel

The output voltage and current of the PV panel are measured and fed to the fuzzy based MPPT control unit for MPP tracking. Based on the change of power with respect to change of voltage $\frac{dp}{dv}$ and $\Delta \frac{dp}{dv}$, fuzzy determines the voltage reference of the PWM (Pulse Width Modulation) signal. The proposed fuzzy logic based MPPT technique is discussed in section V.

IV. REVIEW OF FUZZY LOGIC

Fuzzy logic uses fuzzy set theory, in which a variable is a member of one or more sets, with a specified degree of membership. Fuzzy logic allow us to emulate the human reasoning process in computers, quantify imprecise information, make decision based on vague and in complete

data, yet by applying a “defuzzification” process, arrive at definite conclusions.

The FLC mainly consists of three blocks

- Fuzzification
- Inference
- Defuzzification

A. Fuzzification

The fuzzy logic controller requires that each input/output variable which define the control surface be expressed in fuzzy set notations using linguistic levels. The linguistic values of each input and output variables divide its universe of discourse into adjacent intervals to form the membership functions. The member value denotes the extent to which a variable belong to a particular level. The process of converting

input/output variable to linguistic levels is termed as Fuzzification.

B. Inference

The behavior of the control surface which relates the input and output variables of the system is governed by a set of rules. A typical rule would be

If x is A THEN y is B

When a set of input variables are read each of the rule that has any degree of truth in its premise is fired and contributes to the forming of the control surface by approximately modifying it. When all the rules are fired, the resulting control surface is expressed as a fuzzy set to represent the constraints output. This process is termed as inference.

C. Defuzzification

Defuzzification is the process of conversion of fuzzy quantity into crisp quantity. There are several methods available for defuzzification. The most prevalent one is centroid method, which utilizes the following formula:

$$\frac{\int (\mu(x)x)dx}{\int \mu(x)dx} \tag{6}$$

where μ is the membership degree of output x.

V. PROPOSED FUZZY LOGIC CONTROLLER

Fuzzy logic is implemented to assist the conventional MPPT technique to obtain the MPP operating voltage point faster and also it can minimize the voltage fluctuation after MPP has been recognized [22]-[24].

The proposed fuzzy logic based MPPT controller, shown in Fig. 5, has two inputs and one output.

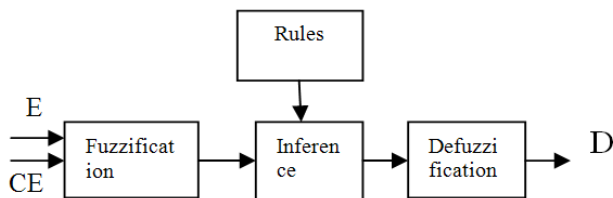

Fig. 5 General diagram of a fuzzy controller

In the proposed fuzzy logic based technique the error (E) and change of error (CE) are taken as input variables which are as below for k^{th} sample time.

$$E(k) = \frac{dP}{dV} = \frac{P_{ph}(k) - P_{ph}(k-1)}{V_{ph}(k) - V_{ph}(k-1)} \tag{7}$$

$$CE(k) = E(k) - E(k-1) \tag{8}$$

where $P_{ph}(k)$ is the power of the photovoltaic generator. The input E (k) shows the change of power with respect to the

change of voltage. Another input CE (k) expresses the change of error.

Case (A) Gaussian Membership Functions

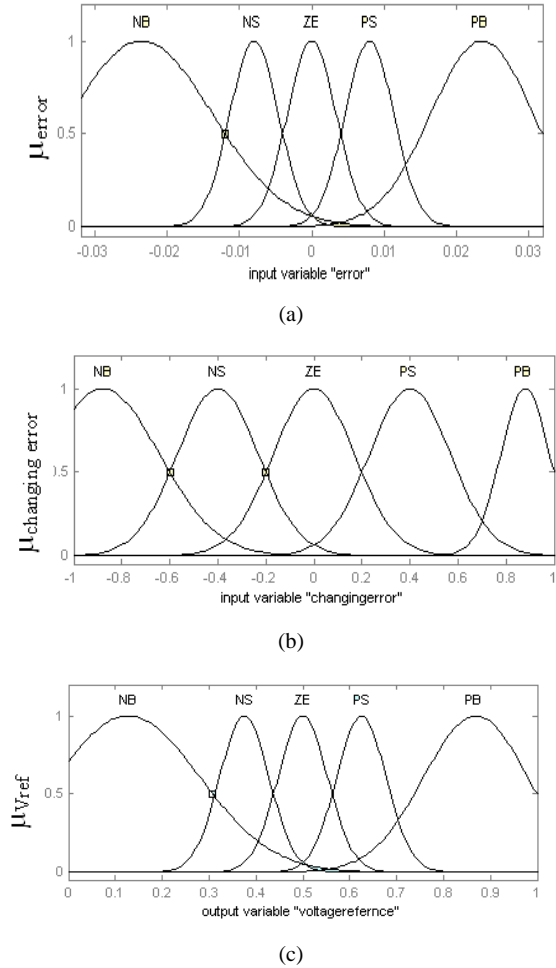

Fig. 6 Membership functions of (a) error E (b) Changing error CE (c) Voltage reference V_{ref}

TABLE II
FUZZY RULE TABLE FOR GAUSSIAN MEMBERSHIP FUNCTIONS

		E				
		NB	NS	ZE	PS	PB
CE	NB	ZE	ZE	PB	PB	PB
	NS	ZE	ZE	PS	PS	PS
	ZE	PS	ZE	ZE	ZE	NS
	PS	NS	NS	NS	ZE	ZE
	PB	NS	NB	NB	ZE	ZE

In this case, the membership functions are represented by using Gaussian membership functions. To design the FLC, variables which can represent the dynamic performance of the system to be controlled, should be chosen as the inputs to the controller. In the proposed method, the derivative of the change of power with respect to change of voltage (dP/dV) and change of (dP/dV) are considered as the inputs of the FLC and the voltage reference for modulated signal generation is taken as the output of the FLC. The input and output variables

are converted into linguistic variables. In this case, five fuzzy subsets, NB (Negative Big), NS (Negative Small), ZE (Zero), PS (Positive Small) and PB (Positive Big) have been chosen. Membership functions used for the input and output variables are shown in Fig. 6. As both inputs have five subsets, a fuzzy rule base formulated for the present application is given in Table II.

Case (B) Triangular Membership Functions

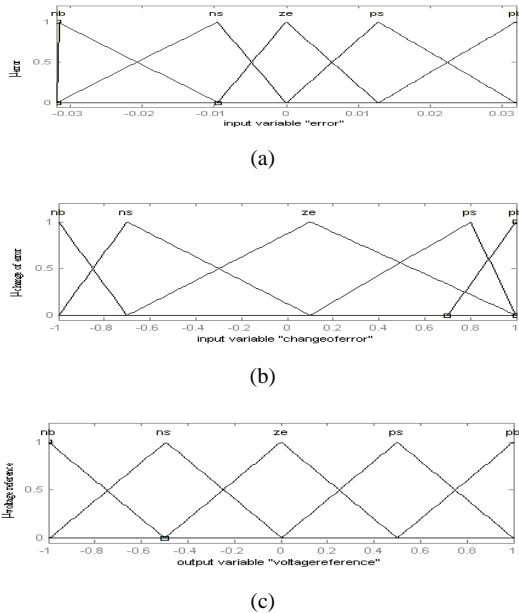

Fig. 7 Membership functions of (a) error E (b) Change of error CE (c) Voltage reference V_{ref}

TABLE III
FUZZY RULE TABLE FOR TRIANGULAR MEMBERSHIP FUNCTIONS

CE \ E	E				
	NB	NS	ZE	PS	PB
NB	NB	NB	NS	NS	Z
NS	NB	NS	NS	Z	PS
Z	NS	NS	Z	PS	PS
PS	NS	Z	PS	PS	PB
PB	Z	PS	PS	PB	PB

In this case, the membership functions are represented by using triangular membership functions. Membership functions used for the input and output variables are shown in Fig. 7. As both inputs have five subsets, a fuzzy rule base formulated for the present application is given in Table III. The performances of fuzzy logic based MPP tracking are able to reduce the perturbed voltage after the MPP operating voltage has been recognized.

VI. SIMULATION RESULTS

The PV module is modeled in MATLAB-SIMULINK using (3) with the assumption that the PV module has constant temperature of 25°C. The PV module contains 200 solar cells in series, and generates the output voltage as 120V. A pure

resistive load is connected to the PV module through the buck boost dc-dc converter. The performance of the proposed technique has been examined for fixed solar radiance at 1000W/m².

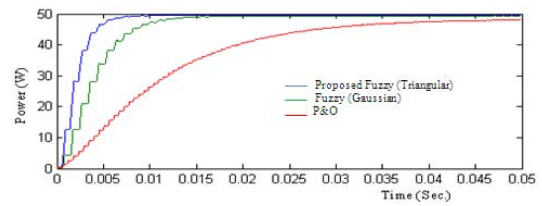

(a) Power

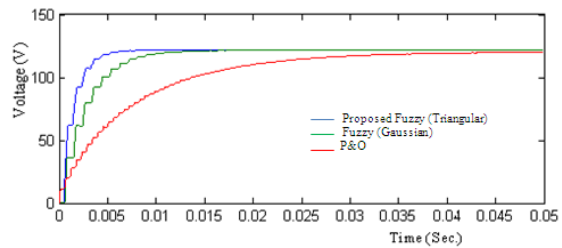

(b) Voltage

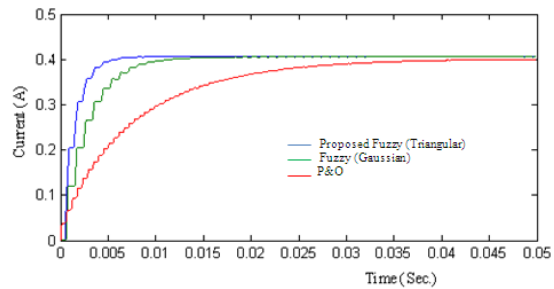

(c) Current

Fig. 8 Fuzzy, P&O, proposed fuzzy responses for standard conditions of temperature 25°C and irradiation 1000W/m²

Figs. 8 (a)-(c) show the results of PV operating power, voltage and current of the triangular and Gaussian membership functions, respectively. From this figure, it is observed that the Gaussian membership functions can track the maximum power point at 0.015s and also it generates constant voltage without any deviations. The performance of the fuzzy based MPPT technique is compared with the conventional P&O MPPT. It shows that the conventional P&O MPPT tracks the maximum power point at 0.04s and also it does not have the ability to reduce the perturbed voltage.

From Fig. 8 (a), it is observed that the proposed triangular membership functions can track the maximum power operating point faster. It tracks the MPPT at 0.005s but the Gaussian membership function based fuzzy tracks the maximum power operating point voltage at 0.015s. Hence from the investigation, it is clear that the PV power which is controlled by the proposed triangular membership function is more stable than the conventional MPPT techniques.

VII. CONCLUSION

This paper has presented an intelligent MPPT control strategy for the PV system using fuzzy logic controller. The maximum power point tracking technique was simulated using MATLAB/Simulink. The proposed fuzzy logic based MPPT technique with triangular membership functions can track the maximum power point faster compare to the Gaussian membership functions. It has the capability of reducing the voltage fluctuation after MPP has been recognized. The simulation results show the efficiency of the fuzzy logic controller in maintaining the stable maximum power point.

REFERENCES

- [1] J. Applebaum, "The Quality of Load Matching in a Direct coupling Photovoltaic System ", IEEE Trans. On Energy Conversion, Vol. 2, No.4, pp.534-541, Dec. 1987.
- [2] T. Kawamura, K.Hrada, Y.Ishihara, T.Todaka, T. Oshiro, H.Nakamura, M.Imataki, "Analysis of MPPT Characteristics in Photovoltaic Power System", Solar Energy Materials & Solar Cells, Vol. 47, pp.155-165, 1997.
- [3] S.Mekhilef, R. Saidur and A.Safari, "A Review of Solar Energy use in Industries", Elsevier Renewable and Sustainable Energy Reviews, Vol. 15, pp. 1777-1790, 2011.
- [4] K.H. Solangi, M.R. Islam, R.Saidur, N.A. Rahim and H.Fayaz, "A Review on global Sola Energy Policy", Elsevier, Vol.15, pp. 2149-2163, 2011..
- [5] J V.salas, E.Olyas, A. Barrado, A .Lazaro, " Review of The Maximum Power Point Tracking Algorithms for Stand-Alone Photovoltaic Systems", Solar Energy Materials & Solar Cells, Vol. 90, pp. 1555-1578, 2006.
- [6] N. Femia, D. Granozio, G. Petrone, G. Spagnuolo, and M. Vitelli, "Optimized one-cycle control in photovoltaic grid connected applications," IEEE Trans. Aerosp. Electron. Syst., Vol. 42, pp. 954–972, 2006.
- [7] W. Wu, N. Pongratananukul, W. Qiu, K. Rustom, T. Kas-paris, and I. Batarseh, "DSP-based multiple peak power tracking for expandable power system," in Proc. APEC, pp. 525–530, 2003.
- [8] C. Hua and C. Shen, "Comparative study of peak power tracking techniques for solar storage system," in Proc. APEC, pp. 679–685, 1998.
- [9] D. P. Hohm and M. E. Ropp, "Comparative study of maximum power point tracking algorithms using an ex-perimental, programmable, maximum power point track-ing test bed," in Proc. Photovoltaic Specialist Conference, pp. 1699–1702, 2000.
- [10] K. H. Hussein, I. Muta, T. Hoshino, and M. Osakada, "Maximum power point tracking: an algorithm for rapidly chancing atmospheric conditions," IEE Proc.-Gener. Transm. Distrib., Vol. 142, pp. 59–64, 1995.
- [11] X. Sun, W. Wu, X. Li, and Q. Zhao, "A research on photovoltaic energy controlling system with maximum power point tracking," in Power Conversion Conference, pp. 822–826, 2002..
- [12] T. L. Kottas, Y. S. Boutalis, and A. D. Karlis, "New maximum power point tracker for PV arrays using fuzzy controller in close cooperation with fuzzy cognitive net-work," IEEE Trans. Energy Conv., Vol. 21, pp. 793–803, 2006.
- [13] Y. T. Hsiao and C. H. Chen, "Maximum power tracking for photovoltaic power system," in Proc. Industry Application Conference, pp. 1035–1040, 2002.
- [14] G. J. Yu, Y. S. Jung, J. Y. Choi, I. Choy, J. H. Song, and G. S. Kim, "A novel two-mode MPPT control algorithm based on comparative study of existing algorithms," in Proc. Photovoltaic Specialists Conference, pp. 1531–1534, 2002.
- [15] M. Park and I. K. Yu, "A study on optimal voltage for MPPT obtained by surface temperature of solar cell," in Proc. IECON, pp. 2040–2045, 2004.
- [16] T. Takashima, T. Tanaka, M. Amano, and Y. Ando, "Maximum output control of photovoltaic (PV) array," in Proc. 35th Intersociety Energy Convers. Eng. Conf. Ex-hib., pp. 380–383, 2000.
- [17] P. C. M. de Carvalho, R. S. T. Pontes, D. S. Oliveira, D. B. Riffel, R. G. V. de Oliveira, and S. B. Mesquita, "Control method of a photovoltaic powered reverse osmosis plant without batteries based on maximum power point track-ing," in Proc. IEEE/PES Transmiss. Distrib. Conf. Expo.: Latin America, pp. 137–142, 2004.
- [18] Roberto Farada and Sonia Leve "Energy Comparison of MPPT techniques for PV Systems", WSEA Trans. On Power Systems, pp. 446-455, 2008..
- [19] Trishan Efram, and Patrick L. Chapman, "Comparison of Photovoltaic Array Maximum Power Point Tracking Techniques", IEEE Trans. On Energy Conversion, VOL. 22, NO. 2, pp. 439-449, 2007.
- [20] Marcello Gradella Villallava, Jonas Rafael Gazali, and Ernsto ruppert Filho, "Comprehensive Approach to Modeling and Simulation of Photovoltaic Array", IEEE Tran. Of Power Electronics, Vol. 24, pp. 1198-1208., 2009.
- [21] M.G. Villalva, J.R. Gazoli, E. Ruppert "Modeling and Circuit Based Simulation of Photovoltaic Arrays", Journal of Power Electronics, Vol.14, pp. 34-45.
- [22] C.S. Chin, P. Neelakantan, H.P. Yoong, K.T.K. Teo,"Optimization of Fuzzy based MPPT in PV System for Rapidly Changing Solar Irradiance", Transaction on Solar Energy and Planning, 2011.
- [23] Dr. P. Rathika and Dr. D. Devaraj " Fuzzy Logic Based Approach for Adaptive Hysteresis Band and Dc Voltage Control in Shunt Active Filter", Vol. 2, No. 3, June, pp.1793-8163, 2010.
- [24] S .Karthika, Dr.P.Rathika and Dr D. Devaraj , "Fuzzy Logic Based Maximum Power Point Tracking for Photovoltaic Systems", JCSMR pp.18-22, 2013.