

Forward Simulation of a Parallel Hybrid Vehicle and Fuzzy Controller Design for Driving/Regenerative Propose

Peyman Naderi, Ali Farhadi, and S. Mohammad Taghi Bathaee

Abstract—One of the best ways for achievement of conventional vehicle changing to hybrid case is trustworthy simulation result and using of driving realities. For this object, in this paper, at first seven-degree-of-freedom dynamical model of vehicle will be shown. Then by using of statically model of engine, gear box, clutch, differential, electrical machine and battery, the hybrid automobile modeling will be down and forward simulation of vehicle for pedals to wheels power transformation will be obtained. Then by design of a fuzzy controller and using the proper rule base, fuel economy and regenerative braking will be marked. Finally a series of MATLAB/SIMULINK simulation results will be proved the effectiveness of proposed structure.

Keywords—Hybrid, Driving, Fuzzy, Regeneration.

I. INTRODUCTION

FUEL economy and regenerative braking in the hybrids vehicles, are the main of important qualified factors in the control strategy of these vehicles. Decreasing used fossil fuels cause the attention to the vehicles with twin power sources that are known the hybrid vehicles. In the most of recent researches, various control strategies are proposes for power split between engine and electrical machine in the hybrid vehicles. In [1] a model base on the real time road control strategy for parallel hybrid vehicles was presented and in [2] an optimal control strategy that choose the power split between the engine and electrical machine for minimize the fuel consumption in the parallel hybrid vehicles, was presented. In [3] with using field oriented control of a permanent magnet motor and belt coupling with crankshaft, fuel economy of vehicle was proved. The Result of Ph.d. research was the vehicle simulation program that was able to simulated behavior of various components of hybrid vehicles [4]. Due to non linear model of the vehicle, the most usual controllers are base on the neural networks and fuzzy systems. In [5], by using an electrical machine on each of the non- driven wheels and design of fuzzy controllers, fuel economy and regenerative

Peyman Naderi is academic member of electrical engineering department of Islamic Azad University of Iran, Borujerd branch. (Corresponding author to provide phone: +98-916-399-9656; e-mail: naderi@ ee.kntu.ac.ir).

Ali Farhadi is teacher of mechanical engineering department of Shahid Rajaei University of Iran, Tehran, Iran (e-mail: a.farhadi@stuu.ac.ir)

S. Mohammad Taghi Bathaee is academic member with professor assistant degree of electrical engineering department of K.N.Toosi University of Iran, Tehran, Iran (e-mail: bathaee@kntu.ac.ir).

braking and vehicle stability was introduced. Now in This paper for fuel economy and regenerative braking, using a small electrical machine and belt coupling with crankshaft will be marked for changing of conventional to parallel hybrid vehicle.

II. PROPOSED STRUCTURE

In conventional vehicles, usually there is not proper prediction for electrical machine using. Due of this fact, the best structure for its converting to hybrid vehicle, is the parallel structure considering and using the small electrical machine and other electrical devices. In this paper, the belt coupling between the typical small electrical machine and crankshaft of typical vehicle and its subsystems such as Transmission, wheels, body and other subsystems, will be considered. Fig. 1 shows proposed structure.

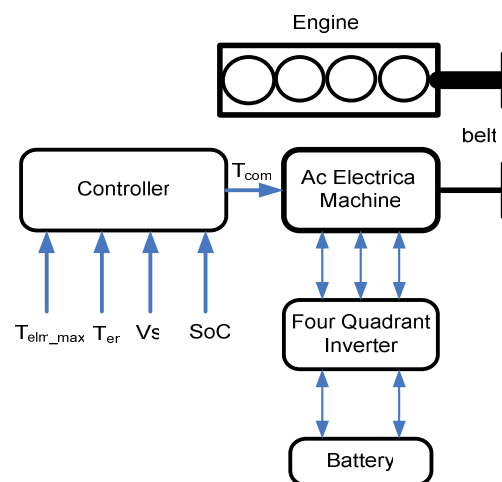

Fig. 1 Proposed structure for changing to micro parallel hybrid vehicle

In this figure:

Symbol	Definition
T_{elm_max}	Maximum available torque of electrical machine
T_{en}	Engine output torque
V_s	Vehicle Speed
SoC	Battery state of charge
T_{com}	Torque command to electrical machine controller

Driver power demand will be provided from electrical machine and gasoline engine. Engine speed is relative to

vehicle speed in usual condition and electrical machine speed is relative to engine speed by influence of belt coefficient. So sum of applied torques by engine and electrical machine will be important for driving. Braking torque will be applied to wheels by braking pedal directly. Base on these descriptions, in this paper driving and braking applied torque by electrical machine will be computed by the controller. In other hands, the vehicle fuel used is base on the various forces applied on the vehicle and computing of these forces is relative to subsystems behavior under the various driving conditions. Future descriptions will be shows in future sections of paper.

III. VEHICLE BODY MODELING

A seven-degree-of-freedom model is used for the simulation purposes [5],[6]. Where, three degrees are devoted to the chassis motion and four degrees are assigned to the angular speed of the wheels. Fig. 2 shows the wheel forces and vehicle body model. In this figure the fl, fr, rl and rr denotes to front left, front right, rear left and rear right respectively.

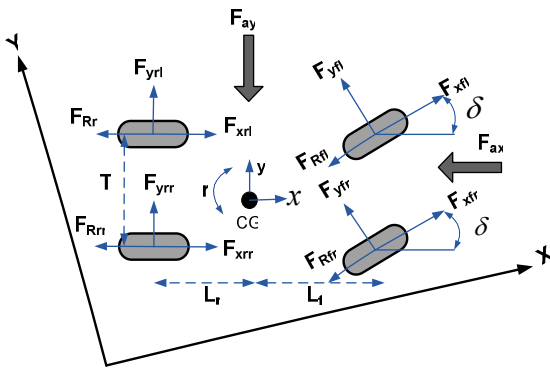

Fig. 2 Seven degrees of freedom vehicle body model

In this figure, for i: fl, fr, rl, rr :

Symbol	Definition
F_{xi}	Longitudinal force of wheel
F_{yi}	Lateral force of wheel
F_{Ri}	Rolling resistance force of wheel
F_{ax}, F_{ay}	Aerodynamic drag forces
X, Y	Denotation to static reference frame
x, y	Denotation to moving reference frame
δ	Steer angle
CG	Corresponding to vehicle centre of gravity

Considering the action forces on the vehicle, as depicted in Fig. 2, one can write the vehicle motion equation as below.

$$M_t(\dot{u} - rv) = F_{xfl}\cos(\delta) - F_{yfl}\sin(\delta) + F_{xfr}\cos(\delta) + F_{yfr}\sin(\delta) + F_{xrl} + F_{xrr} - F_{ax} \quad (1)$$

$$M_t(\dot{v} + ru) = F_{xfl}\sin(\delta) + F_{yfl}\cos(\delta) + F_{xfr}\sin(\delta) + F_{yfr}\cos(\delta) + F_{yrl} + F_{yrr} - F_{ay} \quad (2)$$

$$M_z \dot{r} = L_f [F_{xfl}\sin(\delta) + F_{yfl}\cos(\delta) + F_{xfr}\sin(\delta) + F_{yfr}\cos(\delta)] - L_r [F_{yrl} + F_{yrr}] + T/2 [F_{xfl}\cos(\delta) - F_{yfl}\sin(\delta) - F_{xfr}\cos(\delta) + F_{yfr}\sin(\delta) + F_{xrl} - F_{xrr} + M_{zfl} + M_{zfr} + M_{zrl} + M_{zrr}] \quad (3)$$

$$I_z \dot{r} = L_f [F_{xfl}\sin(\delta) + F_{yfl}\cos(\delta) + F_{xfr}\sin(\delta) + F_{yfr}\cos(\delta)] - L_r [F_{yrl} + F_{yrr}] + T/2 [F_{xfl}\cos(\delta) - F_{yfl}\sin(\delta) - F_{xfr}\cos(\delta) + F_{yfr}\sin(\delta) + F_{xrl} - F_{xrr} + M_{zfl} + M_{zfr} + M_{zrl} + M_{zrr}]$$

Where M_z is the wheel self aligning torque and I_z denote to vehicle moment of inertia about z axis and M_i is total vehicle mass.

IV. TIRE MODELING

Tire is one of the most important and ambiguous components to modeling of vehicle. By applying the mover torque (τ_w) on the wheel, it will be rotated as following:

$$I_{wi} \dot{\omega}_i = \tau_{wi} - R_w F_{xi} - \tau_{Ri} - R_w F_{zi} \sin(\theta) \quad \text{for } i: fl, fr, rl, rr \quad (4)$$

θ is road grad and I_w and R_w are wheel moment of inertia and wheel radius respectively, ω is Angular speed of wheel and τ_R denote to wheel rolling resistance torque that is one of the important forces for vehicle fuel consumption computing.

$$\tau_R = C_0 F_z + C_1 |V_w|^2 \quad (5)$$

V_w is the wheel linear speed and usually $0.04 \leq C_0 \leq 0.2$ and $C_1 \ll C_0$. In this paper the well known Dugoff's model for longitudinal and lateral tire forces will be used. In this model [5]:

$$F_{xi} = \begin{cases} \frac{C_x \lambda_i}{1 - \lambda_i} & \text{for } H_i < 0.5 \\ \frac{C_x \lambda_i}{1 - \lambda_i} \left(\frac{1}{H_i^2} - \frac{1}{4H_i^2} \right) & \text{for } H_i > 0.5 \end{cases} \quad (6)$$

$$F_{yi} = \begin{cases} \frac{C_y \tan(\alpha_i)}{1 - \lambda_i} & \text{for } H_i < 0.5 \\ \frac{C_y \tan(\alpha_i)}{1 - \lambda_i} \left(\frac{1}{H_i^2} - \frac{1}{4H_i^2} \right) & \text{for } H_i > 0.5 \end{cases} \quad (7)$$

H_i will be computed as below:

$$H_i = \left[\left(\frac{C_x \lambda_i}{\mu_i F_{zi} (1 - \lambda_i)} \right)^2 + \left(\frac{C_y \tan(\alpha)}{\mu_i F_{zi} (1 - \lambda_i)} \right)^2 \right]^{1/2} \quad (8)$$

C_x, C_y are the longitudinal and lateral tire stiffness and λ, α are longitudinal and lateral wheel slip respectively that can be computed by known relationships [5]. F_z is the vertical force on the tire with influence of vehicle longitudinal and lateral accelerations.

In (8), $\mu_i = \mu_{peak,i} (1 - A_s R_w (\lambda_i^2 + \tan^2(\alpha_i)))^{1/2}$ where $\mu_{peak,i}$ is Friction coefficient and A_s is the wheel contact area.

V. TRANSMISSION MODELING

Transmission subsystems are consisting of engine, gear box, clutch, brake and differential. The output engine power is transferred to driven wheels via the clutch, gear box, and differential. But braking torque is transferred to all wheels directly by the brake pedal command. Due to input and output power equivalence in gear box and differential systems, modeling of these subsystems can be down by affect of constant coefficients [5].

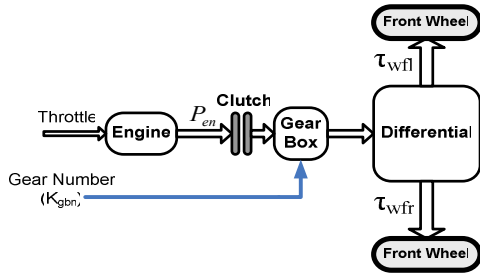

Fig. 3 Transmission subsystems structure

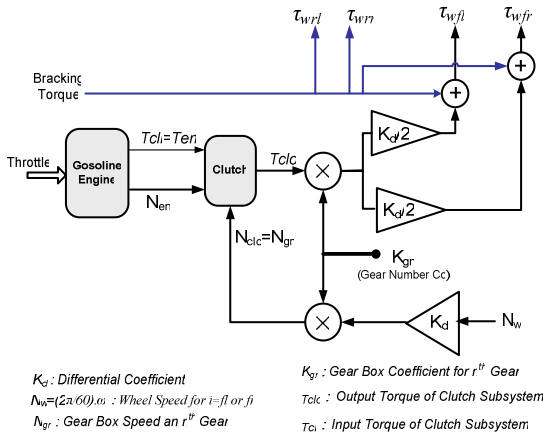

Fig. 4 Transmission subsystems modeling

For simulation, it is assumed that the engine and gear box speeds are equal in usual conditions. But it will be violated in some of cases such as low speed or driving by improper gear. In these conditions, the engine power will be wasted in the clutch subsystem [5]. Fig. 5 shows the clutch power Transmission curve.

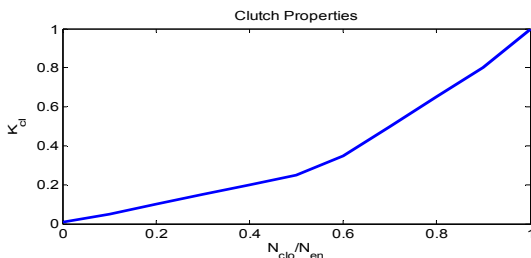

Fig. 5 Clutch power Transmission curve

In Figs. 4, 5:

Symbol	Definition
K_{gn}	Gear coefficient at gear no n
K_d	Differential gear coefficient
N_{en}	Engine output speed
T_{en}	Engine output torque
N_{cli}	Gear box speed at gear no n
T_{clo}	Output clutch torque (Gear box input torque)
$K_{cl} = T_{clo}/T_{cli}$	Clutch Torque Transferred Coefficient

For engine modeling, engine torque and fuel consumption will be computed on the basis of the engine maps. One of these maps computes the shaft torque base on the throttle opening and shaft speed. The engine fuel used will be determined according to shaft speed and shaft torque. Based on the previous illustrations, the shaft speed will be determined by the vehicle speed in usual conditions so, driver power demand will be requested by the throttle and brake pedals in positive and negative accelerations respectively. Fig. 6 and 7 shows the engine maps used for paper continuation and simulation. These are obtained from known 'ADVISOR' simulation program [7].

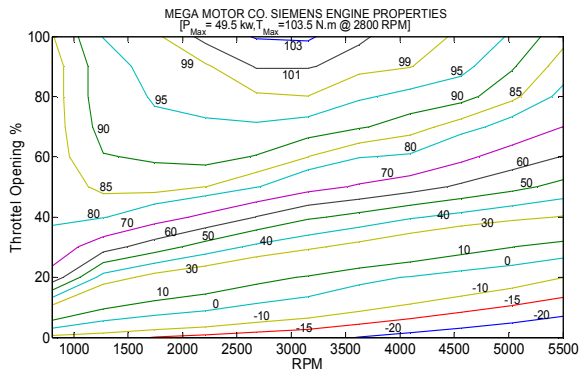

Fig. 6 Engine torque based on the throttle opening and shaft speed

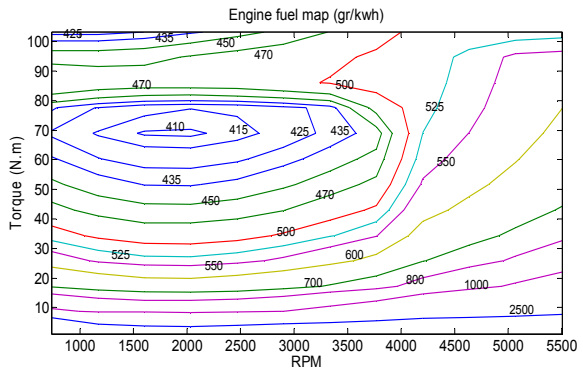

Fig. 7 Engine fuel used based on the throttle opening and shaft speed

To attention of Fig. 6, in same case, the engine output torque is negative. This case will occur because of shortage engine power relative to driven wheels power such as downhill driving condition. This fact can be used for power regeneration when there is not any pressure on the brake pedal and vehicle negative acceleration is needed

VI. ELECTRICAL MACHINE MODELING

In electrical machine model the efficiency and maximum torque of rotor are available [5], [7].

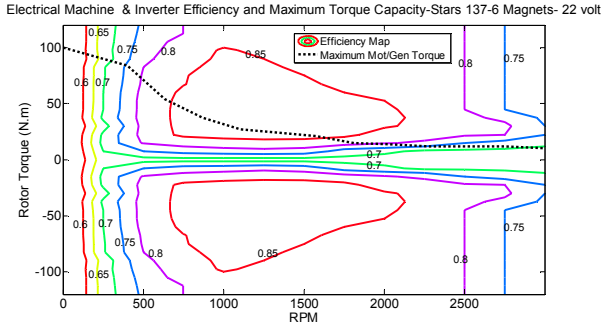

Fig. 8 Electrical machine curves

VII. BATTERY MODELING

Battery state of charge is most important control signal in the hybrid vehicle. In this paper, one of the well known battery model will be used. It is based on the variable voltage source and internal variable resistance depending on SoC. Figs. 9 and 10 shows this model and typical values of its parameters [5],[7].

One of the simple and well known formulas for SoC is the calculation as comes below where SoC₍₀₎ is the initial state of charge, Ah_{cap} and Ah_{used} are maximum and used battery Amper.hour respectively and I_b is the battery current.

$$SoC_{charge} = (Ah_{cap} - Ah_{used}) / Ah_{cap} \tag{9}$$

$$Ah_{used} = Ah_{cap} (1 - SoC_{(0)}) + \int (I_b / 3600) dt \tag{10}$$

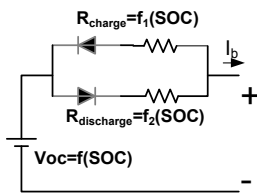

Fig. 9 The 'R_Internal' battery model

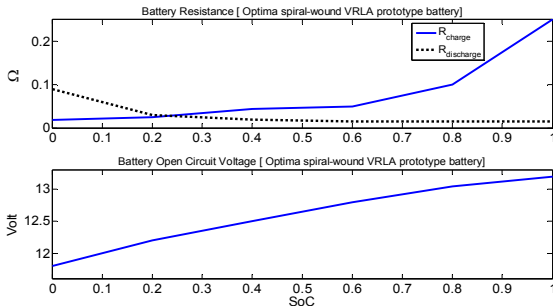

Fig. 10 Internal parameters of battery

VIII. HYBRID VEHICLE STRUCTURE

According to Fig. 1, the belt coupling between the electrical machine and crankshaft is considered. In this case, rotor speed will be based on the crankshaft speed and rate of the belt coupling. Fig. 11 shows this structure.

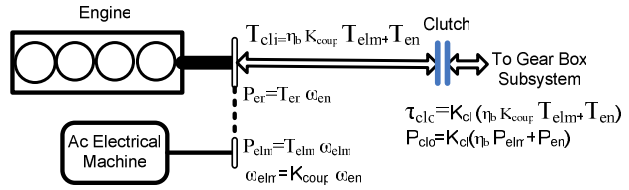

Fig. 11 Hybrid vehicle power-Train structure

In this figure:

Symbol	Definition
T_{elm}	Electrical machine torque
$n_{elm} = 60 \cdot \omega_{elm} / (2\pi)$	Electrical machine speed
$n_{en} = 60 \cdot \omega_{en} / (2\pi)$	Engine speed (RPM)
K_{coup}	Speed change rate of belt
η_b	Belt efficiency

IX. DRIVER MODELING

For simulation of driver behavior in pedals pressure, a simple PID controller can be used. For gear changing simulation, it is assumed that the changing is based on the throttle opening and vehicle speed experimentally. Fig. 12 shows this part of simulation structure.

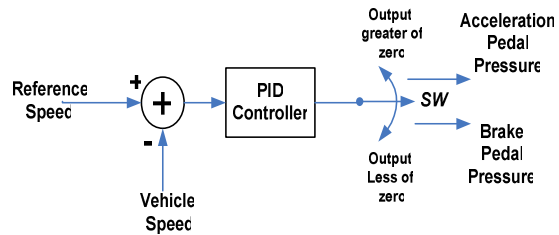

Fig. 12 Simple PID controller for pedals pressure simulation

X. CONTROL STRATEGY AND ITS STRUCTURE

According to section II and Fig. 1, the belt coupling is assumed between the electrical machine and crankshaft. To attention of Fig. 6, in some cases, such as motion in steep road, in full jointing of clutch surfaces, there is power revocation from driven wheels to engine and the engine torque will be negative as shown in lower part of Fig. 6. This fact will be used in the control strategy for assistant driving torque and regenerative braking torque applies detection. Fig. 13 shows the controller structure while the clutch surfaces are connecting to each other and in the nonzero speed. Engine torque can be calculated from engine map base on the throttle opening and engine speed as shown in Fig. 6. Sign of the engine torque will be used for electrical machine operation in motoring or generating mode operation in control strategy. According to electrical machine placement, any action of the controller will be effected only during of full connection of the clutch surfaces. So in this structure the brake pedal has not any intervene in the controller structure and its strategy.

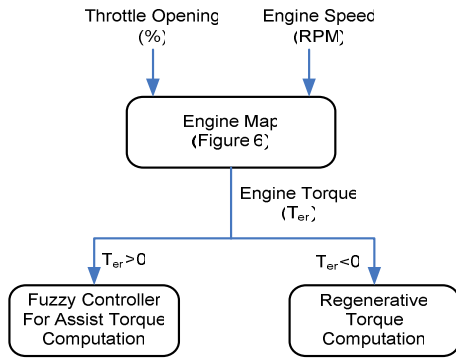

Fig. 13 Controller structure

According to Fig. 13, there are two modes for assistant and regeneration applied torque by electrical machine to associate of gasoline engine. Explication of overall controller operation is written as below:

A fuzzy controller will be designed for assisting applied torque in driving case. In this mode the assisting torque will be applied according to battery state of charge (SoC) and vehicle speed. Whatever the vehicle speed be low and SoC be high, the applied torque will be more. In this mode, generation mode operating of electrical machine has been allocated in low SoC and high speed. In negative engine torque, electrical machine operation will be changed to generating mode. In this case there is not any relation between the generation torques applied and other parameters. Fig. 14 shows detail of the control strategy.

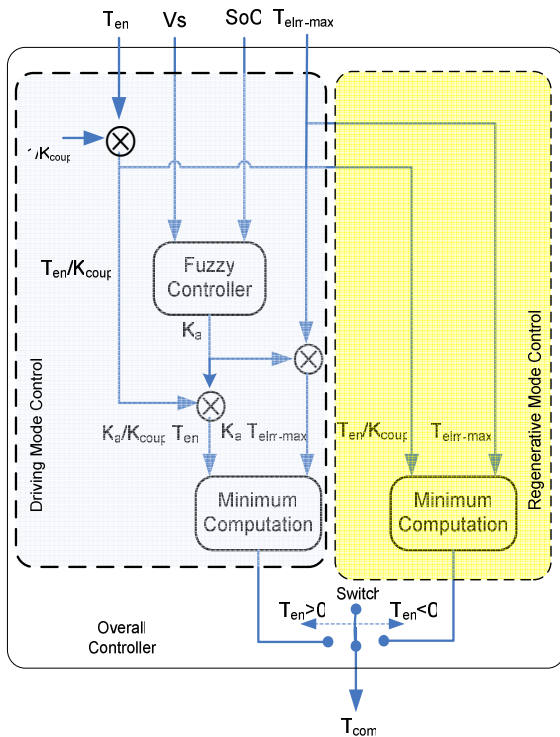

Fig. 14 Control strategy

In this figure:

Symbol	Definition
V_s	Vehicle Speed
K_a	Fuzzy controller output
SoC	Battery state of charge

Base on the Fig. 14, the maximum torque available of the electrical machine will be limited by the fuzzy controller. In addition, associating share of the electrical machine will be determinate by this controller. Input and output memberships of this controller are shows in Fig. 15.

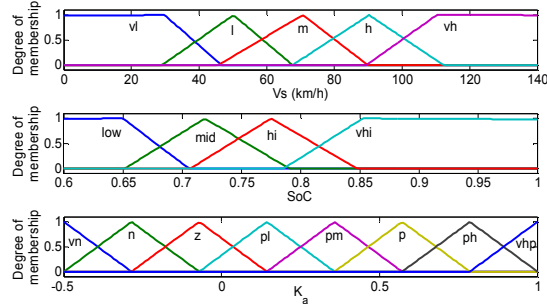

Fig. 15 Fuzzy controller memberships

The fuzzy rule base of the fuzzy controller is tabulated as below:

TABLE I
FUZZY CONTROLLER RULE BASE

		V_s				
		vl	l	m	h	vh
SoC	vhi	vhp	ph	p	pm	pl
	hi	ph	p	pm	pl	z
	mid	p	pm	pl	z	n
	low	pm	pl	z	n	vn

In attention of Table I and Fig. 15, the fuzzy controller will be tried to provide of equal assistant torque with engine torque in the best condition (higher SoC & lower speed).

XI. SIMULATION RESULTS

Typical parameters of the certain automobile that known 'PRIDE' and typical properties of the electrical devices [7] are tabulated as below for simulation:

TABLE II
ENGINE DATA

Parameter	Symbol	Unit	Value
Maximum Power	$P_{en(max)}$	Kw	49.5
Maximum Torque	$T_{en(max)}$	N.m	103.3 @ 2800 RPM
Maximum Speed	$N_{en(max)}$	RPM	5500
Engine Map	Based on figures 6 and 7		

TABLE III
GEAR BOX DATA

Gear Number	Coefficient	Symbol
1	3.454	K_{g1}
2	1.944	K_{g2}
3	1.275	K_{g3}
4	0.861	K_{g4}

5	0.692	K_{gs}
---	-------	----------

TABLE IV
BATTERY DATA

Parameter	Unit	Value
Capacity	A.h	25
Number of Battery	No unit	2
Total Weight	Kg	16
Internal properties :		Based on figure 10

TABLE V
ELECTRICAL MACHINE DATA

Parameter	Unit	Value
Nominal power	Kw	3.6
Weight	Kg	10
Operation properties :		Based on figure 8

TABLE VI
BELT DATA

Parameter	Symbol	Value
Speed change rate	K_{coup}	0.333
Belt efficiency	η_b	0.975

TABLEVII
CLUTCH AND DIFFERENTIAL DATA

Parameter	Symbol	Value
Differential coefficient	K_d	3.78
Clutch properties:		According to figure 5

TABLE VIII
VEHICLE BODY DATA

Parameter	Symbol	Unit	Value
Total vehicle mass	M_t	Kg	1160
Distance of front axle to CG	L_f	m	1.097
Distance of rear axle to CG	L_r	m	1.247
Track width	T	m	1.4
Drag coefficient	C_d	$N.s^2/m^2$	0.41
Frontal area	A_F	m^2	1.8
Lateral area	A_L	m^2	4.5
Vehicle inertia about z axis	I_z	Kgm^2	7809

TABLE IX
WHEEL DATA

Parameter	Symbol	Unit	Value
Longitudinal stiffness	C_x	N	17500
Lateral stiffness	C_y	N/rad	15000
Wheel radius	R_w	m	0.272
Wheel inertia	I_w	Kgm^2	3.264

TABLE X
APPROXIMATELY CHANGED PARAMETERS IN HYBRID CASE

Parameter	Symbol	Unit	Value
Total Vehicle Mass	M_t	Kg	1200
Distance of front axle to CG	L_f	m	1.100
Distance of rear axle to CG	L_r	m	1.244

For proposed controller structure and its strategy testing, some various driving cycles will be simulated. In all scenarios, the comparison between the conventional and hybrid cases will be down.

A. Civic Driving Cycles

In this part, three standard driving cycles [7] are testes. In all of these driving cycles, the steer angle is set to zero value. Also initial state of charge (SoC₀) is set to 0.95 in hybrid case. Fig. 16 shows driving cycles. Engine behavior, Battery and electrical machine operation, and braking applied torque to each wheel are shows as below for ‘INDIA’ driving cycle. Fuel consumptions and comparison for all three driving cycles are tabulated in Table XI.

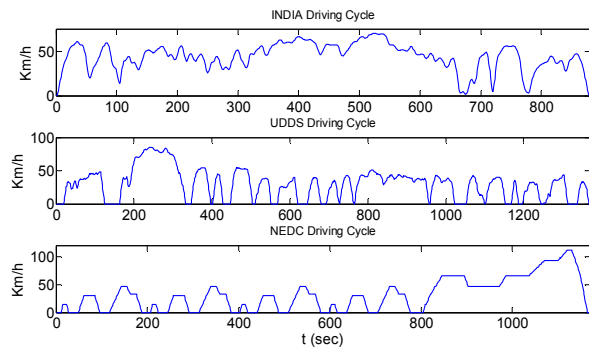

Fig. 16 Civic driving cycles

TABLE XI
FUEL CONSUMPTION AND COMPARISON

DRIVING CYCLE	CONVENTIONAL L/(100 Km)	HYBRID L/(100Km)	FUEL ECONOMY
INDIA	5.87	5.175	11.50%
UDDS	7.73	6.95	10.12%
NEDC	7.39	6.728	8.96%

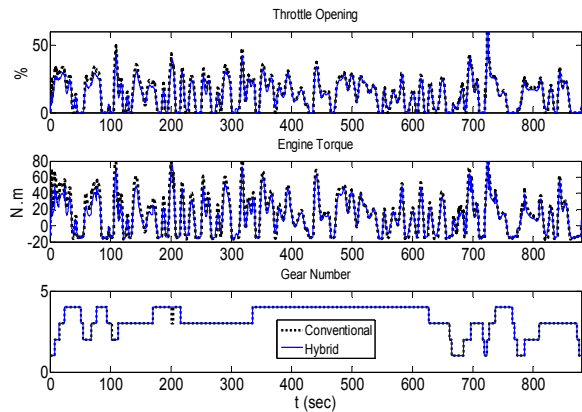

Fig. 17.a Engine and gear box behavior in ‘INDIA’ cycle

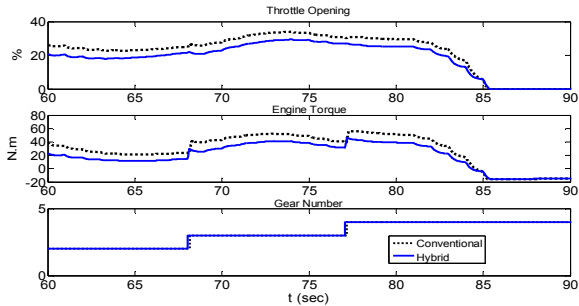

Fig. 17.b Fig. 17.a in $60^{sec} < t < 90^{sec}$

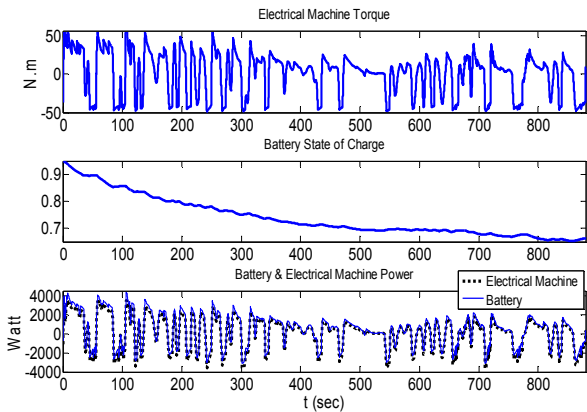

Fig. 18.a Battery and electrical machine behavior in 'INDIA' cycle

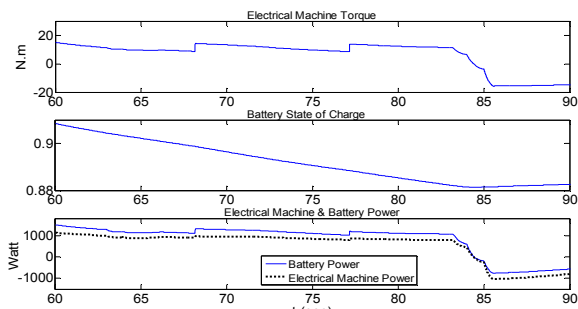

Fig. 18.b Fig. 18.a for $60^{sec} < t < 90^{sec}$

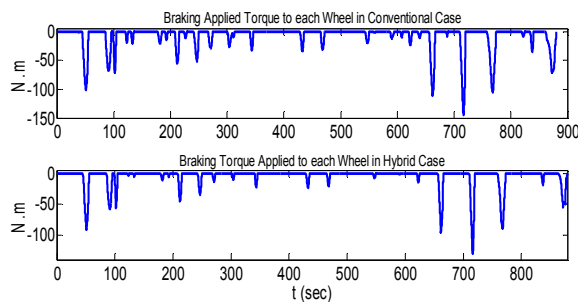

Fig. 19 Braking torque applied to wheel in 'INDIA' cycle

To attention of Figs. 17.a and 17.b, throttle opening and engine torque in the hybrid case is lower than conventional case. Also by noticing to Fig. 19, braking torque applied in the

hybrid case is lower than conventional case.

B. Motion in alpine road

Next simulation performs motion at 50 km/h on alpine road. During of simulation, the road grad and steering angle are assumes to be according to Fig. 20. Engine behavior, braking torque applied, electrical machine and battery operation are shows as below.

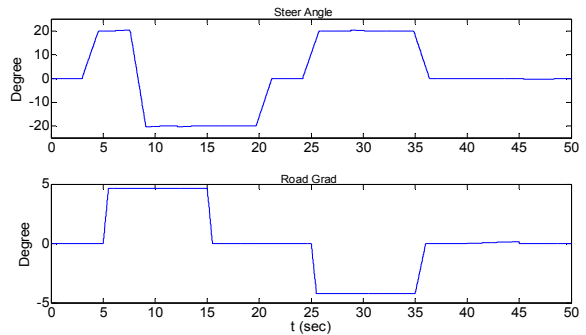

Fig. 20 Steer angle and road grad during of alpine road

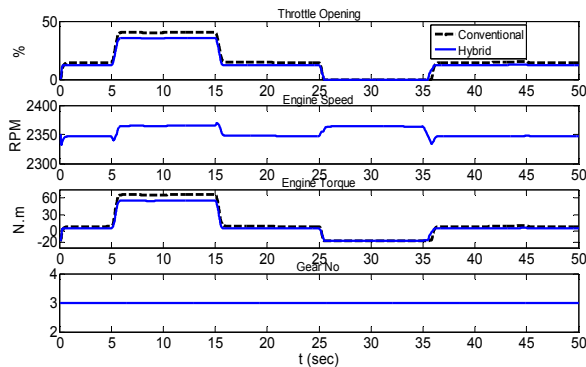

Fig. 21 Engine and gear box behavior

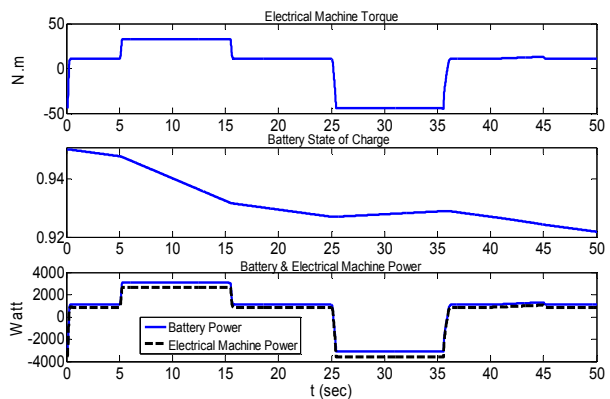

Fig. 22 Battery and electrical machine behavior

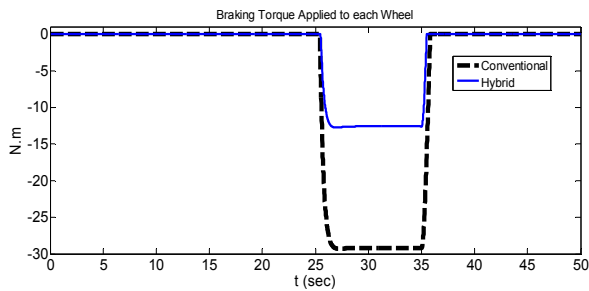

Fig. 23 Braking torque applied to each wheel

To attention of Fig. 22, the battery will be charged during of grad. Also Fig. 23 shows the braking torque, in hybrid case is lower than conventional case.

XII. CONCLUSION

A Driving/Regeneration Braking for a front differential vehicle was introduced by using the electrical traction system. The system is based on fuzzy logic for power management control. Advantages of the proposed controller are the good vehicle modeling and considering of driving realities and the intelligent action of the overall controller system to export of electrical machines torque commands. The effectiveness of the proposed controller was evaluated by MATLAB/SIMULINK simulation. Seven-degree-of-freedom vehicle modeling, dugoff's tire modeling, look of table modeling of electrical components and powertrain subsystems was employed in the simulation program. Excellent performance of the control strategy was proved for fuel economy and regenerative braking in various driving conditions such as civic driving cycles, Downhill/Uphill and alpine road driving.

REFERENCES

- [1] A.Sciarretta, M.Back, L.Guzzella, "Optimal Control of Parallel Hybrid Electric Vehicle", IEEE Transaction on control system Technology. Vol. 12. No. 3. May 2004.
- [2] S.Delpart, J.Lauber, T.Marie, J.Rimoux, "Control of a Parallel Hybrid Powertrain Optimal Control", IEEE Transaction on Vehicular Technology. Vol. 53. No. 3. May 2004.
- [3] R.I.Davis, R.D.Lorenz, "Engine Torque Ripple Cancellation with an Integrated Starter Alternator in a Hybrid Electric Vehicle: Implementation and Control", IEEE conference, 2002, p. 2016-2021.
- [4] J.V. Mierlo, P.V.D.Bossche, G.Maggetto, "Models of energy sources for EV and HEV: fuel cells, batteries ultra capacitors, flywheels and engine-generators" Elsevier, Journal of power sources, 128, 2004, p. 76-89.
- [5] Peyman. Naderi, S.M.Taghi. Bathae, Reza Hosseinzezhad, ' A Multi Objective Fuzzy-Based Controller for Front Differential Vehicles by Electrical Traction System on Non-Driven Wheels', EMS IEEE conference, Chania, Dalian, October 2008.
- [6] F.Tahami, R.Kazemi, S.Farhangi, "Fuzzy Based Stability Enhancement System for Four-Motor-Wheel Electric Vehicles". SAE 2002 Transactions.
- [7] ADVISOR Guide, Advisor, Vehicle simulation program.