

# Exciting Voltage Control for Efficiency Maximization for 2-D Omni-Directional Wireless Power Transfer Systems

Masato Sasaki, Masayoshi Yamamoto

**Abstract**—The majority of wireless power transfer (WPT) systems transfer power in a directional manner. This paper describes a discrete exciting voltage control technique for WPT via magnetic resonant coupling with two orthogonal transmitter coils (2D omni-directional WPT system) which can maximize the power transfer efficiency in response to the change of coupling status. The theory allows the equations of the efficiency of the system to be determined at all the rate of the mutual inductance. The calculated results are included to confirm the advantage to one directional WPT system and the validity of the theory and the equations.

**Keywords**—Wireless power transfer, orthogonal, omni-directional, efficiency.

## I. INTRODUCTION

WIRELESS power transfer (WPT) Systems via magnetic resonant coupling (MRC) have attracted a great deal of attention in recent years and have been reported in [1]–[3]. MRC-WPT systems allow power to traverse large air gaps with high efficiency. MRC-WPT research and developments have been applied to wireless charging systems for electric vehicles and portable equipment such as mobile phones and electric vehicles. While most of the previous works focus on directional WPT, WPT systems consist of multiple coils presented in [4]–[7] have become a new concentration which can overcome the restriction of paired single source and receiver coil. However, the control method for efficiency maximization in MRC-WPT system with orthogonal coils is not reported.

In this paper, the method for controlling the exciting voltage of transmitter coils is proposed. First, the characteristic of relation between efficiency and rate of mutual inductance and rate of exciting voltage is derived. Next, the conditions of the rate of exciting voltage and load resistance for the power transfer efficiency maximization are derived. Finally, the advantage of the proposed method which can maximize the power transfer efficiency of 2-D omni-directional MRC-WPT system is validated by the comparison with the conventional system with paired single transmitter and receiver coil (one directional MRC-WPT system).

Masato Sasaki is with Sharp Corporation, 2613-1, Ichinomoto-cho, Tenri, Nara 632-8567, Japan (corresponding author, e-mail: sasaki.masato@sharp.co.jp).

Masayoshi Yamamoto is Associate Professor of Shimane University, 1060, Nishikawatsu, Matsue, Shimane 690-8504, Japan (e-mail: yamamoto@ecs.shimane-u.ac.jp).

## II. TWO-DIMENSIONAL OMNI-DIRECTIONAL MRC-WPT SYSTEM WITH TWO ORTHOGONAL TRANSMITTER COILS

Fig. 1 shows the 2-D omni-omnidirectional MRC-WPT system with two orthogonal coils. Coil 1 and Coil2 are two orthogonal transmitter coils with a resonant capacitor and Coil3 is the receiver coil loaded with a resonant capacitor and a resistive load  $R_L$ . The center of Coil1 and Coil2 are located at the origin of the coordinate, and the center of Coil3 is located on the X-axis.

The two orthogonal coils are excited with two AC voltage source  $V_1$  and  $V_2$  with the same frequency and phase.  $M_{13}$  is mutual inductance of Coil1 and Coil3, and  $M_{23}$  is mutual inductance of Coil2 and Coil3.

Fig. 2 shows equivalent circuit of WPT system shown in Fig. 1.  $r_1$ ,  $r_2$ , and  $r_3$  are respectively internal resistance of Coil1, Coil2 and Coil3.  $L_1$ ,  $L_2$ , and  $L_3$  are respectively self-inductance of Coil1, Coil2, and Coil3.  $I_1$ ,  $I_2$ ,  $V_1$ , and  $V_2$  are respectively RMS value.

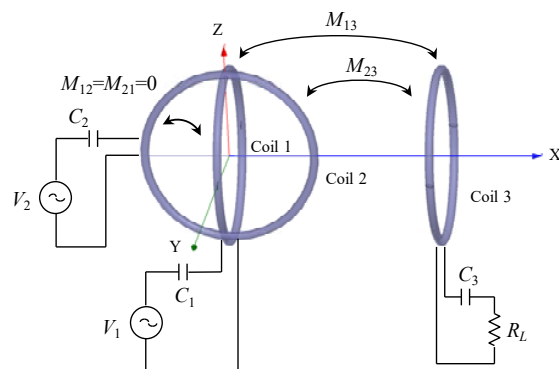

Fig. 1 2-D omni-directional MRC-WPT system with two orthogonal transmitter coils

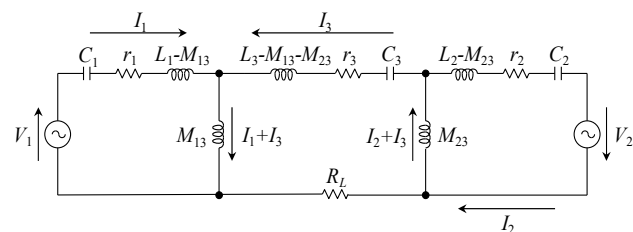

Fig. 2 Equivalent circuit of 2-D omni-directional MRC-WPT system with two orthogonal transmitter coils

### III. ANALYSIS OF WPT SYSTEM WITH TWO ORTHOGONAL TRANSMITTER COILS

#### A. T-Type Equivalent Circuit

According to the equivalent circuit shown in Fig. 2, (1) is given.

$$\left\{ r_3 + R_L + j \left( \omega L_3 - \frac{1}{\omega C_3} \right) \right\} \cdot I_3 + j\omega M_{13} I_1 + j\omega M_{23} I_2 = 0 \quad (1)$$

Inductance and capacitance of receiver coil satisfies (2) because WPT via magnetic resonant coupling sends the power by electrical resonance.

$$\omega L_3 = \frac{1}{\omega C_3} \quad (2)$$

Therefore, the current of Coil3  $I_3$  is expressed as:

$$I_3 = -\frac{j\omega(M_{13}I_1 + M_{23}I_2)}{r_3 + R_L} \quad (3)$$

$V_{M13}$  and  $V_{M23}$  can be expressed by using only the current of transmitter coils  $I_1$  and  $I_2$  as:

$$V_{M13} = \left\{ j\omega M_{13} + \frac{\omega^2(M_{13}^2 - M_{13}M_{23})}{r_3 + R_L} \right\} I_1 + \frac{\omega^2 M_{13}M_{23}}{r_3 + R_L} (I_1 + I_2) \quad (4)$$

$$V_{M23} = \left\{ j\omega M_{23} + \frac{\omega^2(M_{23}^2 - M_{13}M_{23})}{r_3 + R_L} \right\} I_2 + \frac{\omega^2 M_{13}M_{23}}{r_3 + R_L} (I_1 + I_2) \quad (5)$$

According to (4) and (5), the equivalent circuit shown in Fig. 2 can be expressed as T-type equivalent circuit illustrated in Fig. 3.

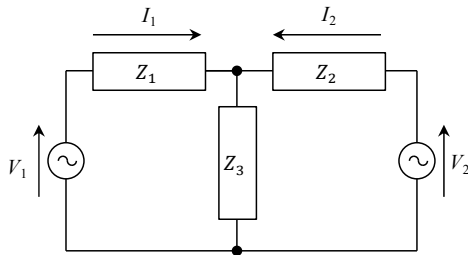

Fig. 3 T-type Equivalent circuit of WPT system with orthogonal transmitter coils

$Z_1$ ,  $Z_2$ , and  $Z_3$  are defined as:

$$Z_1 = j \left( -\frac{1}{\omega C_1} + \omega L_1 \right) + r_1 + \frac{\omega^2(M_{13}^2 - M_{13}M_{23})}{r_3 + R_L} \quad (6)$$

$$Z_2 = j \left( -\frac{1}{\omega C_2} + \omega L_2 \right) + r_2 + \frac{\omega^2(M_{23}^2 - M_{13}M_{23})}{r_3 + R_L} \quad (7)$$

$$Z_3 = \frac{\omega^2 M_{13}M_{23}}{r_3 + R_L} \quad (8)$$

Inductance and capacitance of transmitting coil satisfies (9) and (10) because WPT via magnetic resonant coupling sends the power by electrical resonance.

$$\omega L_1 = \frac{1}{\omega C_1} \quad (9)$$

$$\omega L_2 = \frac{1}{\omega C_2} \quad (10)$$

By substituting (9) and (10) into (6) and (7),  $Z_1$  and  $Z_2$  are expressed as:

$$Z_1 = r_1 + \frac{\omega^2(M_{13}^2 - M_{13}M_{23})}{r_3 + R_L} \quad (11)$$

$$Z_2 = r_2 + \frac{\omega^2(M_{23}^2 - M_{13}M_{23})}{r_3 + R_L} \quad (12)$$

Therefore, T-type equivalent circuit illustrated in Fig. 3 is constituted by resistance and voltage source.

$I_1$ ,  $I_2$ , and  $I_3$  are expressed as:

$$I_1 = \frac{(Z_2 + Z_3)V_1 - Z_3V_2}{Z} \quad (13)$$

$$I_2 = \frac{(Z_1 + Z_3)V_2 - Z_3V_1}{Z} \quad (14)$$

$$I_3 = -\frac{j\omega(M_{13}I_1 + M_{23}I_2)}{r_3 + R_L} \quad (15)$$

where

$$Z = Z_1Z_2 + Z_2Z_3 + Z_3Z_1 \quad (16)$$

#### B. Power Transfer Efficiency

We define the ratio of mutual inductance  $K_M$  and the ratio of driving voltage  $K_V$  as:

$$K_M = \frac{M_{23}}{M_{13}} \quad (17)$$

$$K_V = \frac{V_2}{V_1} \quad (18)$$

From (13)-(18), output power  $P_o$ , input power  $P_{in}$ , and the power transfer efficiency are expressed as:

$$P_o = |I_3|^2 R_L = \frac{\omega^2 R_L M_{13}^2 (r_2 + r_1 K_M K_V)^2}{Z^2 (r_3 + R_L)^2} V_1^2 \quad (19)$$

$$P_{in} = V_1 I_1 + V_2 I_2 = \frac{1}{Z} \left\{ r_1 K_V^2 + \frac{\omega^2 M_{13}^2 (K_M - K_V)}{r_3 + R_L} + r_2 \right\} V_1^2 \quad (20)$$

The partial derivative of the power transfer efficiency  $\eta$  with respect to  $K_V$  is expressed as:

$$\frac{\partial \eta}{\partial K_V} = \alpha (r_1 K_M K_V + r_2) (K_M - K_V) \quad (22)$$

$$\alpha = \frac{2\omega^2 R_L M_{13}^2}{Z(r_3 + R_L)^2} \cdot \frac{\left\{ r_1 r_2 + \frac{\omega^2 M_{13}^2 (r_1 K_M^2 + r_2)}{r_3 + R_L} \right\}^2}{\left\{ r_1 K_V^2 + \frac{\omega^2 M_{13}^2 (K_M - K_V)^2}{r_3 + R_L} + r_2 \right\}} \quad (23)$$

From (22)-(24), the optimal ratio of driving voltage  $K_V$  which maximizes the power transfer efficiency is derived as:

$$\frac{\partial \eta}{\partial K_V} = 0 \quad (24)$$

$$K_{V\_OPT} = K_M \quad (25)$$

By substituting (25) into (21), the optimal power transfer efficiency is expressed as:

$$\eta_{K_V\_OPT} = \frac{\omega^2 M_{13}^2 (r_2 + r_1 K_M^2) \cdot R_L}{r_1 r_2 (r_3 + R_L)^2 + \omega^2 (r_1 M_{23}^2 + r_2 M_{13}^2) (r_3 + R_L)} \quad (26)$$

The partial derivative of the optimal power transfer efficiency expressed as (26) with respect to  $K_V$  is expressed as:

$$\frac{\partial \eta_{K_V\_OPT}}{\partial R_L} = \frac{\omega^2 M_{13}^2 (r_2 + r_1 K_M^2) \{ r_1 r_2 r_3 + \omega^2 (r_1 M_{23}^2 + r_2 M_{13}^2) - r_1 r_2 R_L \}}{\left\{ r_1 r_2 (r_3 + R_L)^2 + \omega^2 (r_1 M_{23}^2 + r_2 M_{13}^2) (r_3 + R_L) \right\}^2} \quad (27)$$

From (22)-(24), the optimal load resistance which maximizes the power transfer efficiency is derived as:

$$R_{L\_OPT\_Proposal} = \sqrt{\frac{r_3 \{ r_1 r_2 r_3 + \omega^2 (r_1 M_{23}^2 + r_2 M_{13}^2) \}}{r_1 r_2}} \quad (28)$$

The maximized power transfer efficiency with the optimized load resistance can be calculated by substituting (28) into (26).

#### IV. COMPARISON OF POWER TRANSFER EFFICIENCY

##### A. Coupling Coefficient

Fig. 4 shows the geometrical relationship of coils in 2-D omni-directional MRC-WPT system with two orthogonal transmitter coils. The distance of the center of the transmitter coils and the center of the receiver coils is 0.25 m. Coil1, Coil2, and Coil3 are the same diameter 0.2 m. The center of Coil3 is fixed to the coordinates (0.2, 0, 0), and  $\theta$  is the rotation angle of Coil3.

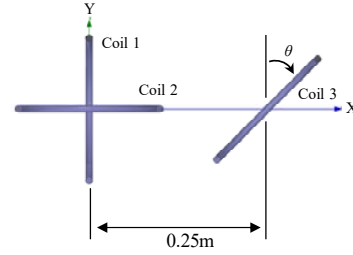

Fig. 4 Geometrical relationship of coils

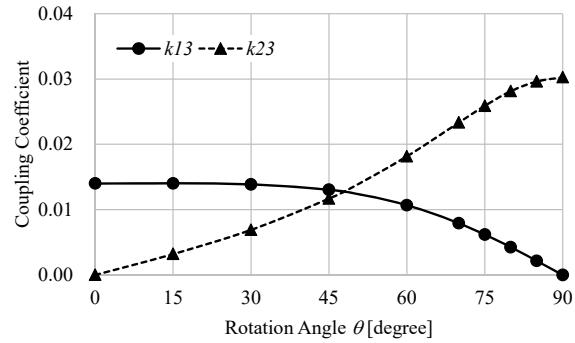

Fig. 5 Coupling coefficient versus rotation angle

Fig. 5 shows the analysis result of the coupling coefficient between the transmitter coils and the receiver coil when the rotation angle  $\theta$  of Coil3 varies.  $k_{13}$  is the coupling coefficient between Coil1 and Coil3,  $k_{23}$  is the coupling coefficient between Coil2 and Coil3. When the angular position of Coil3 is  $\theta=0$ (degree)  $k_{23}$  is zero, so Coil2 and Coil3 are orthogonal to each other, and when the angular position of coil3 is  $\theta=90$ (degree)  $k_{13}$  is zero, so Coil1 and Coil3 are orthogonal to each other.

##### B. Circuit Parameters

Table I shows the circuit parameters of 2-D omni-directional MRC-WPT system with two orthogonal transmitter coils.

The operating frequency  $f_s$  is 6.78 MHz, resistance of Coils is  $r_1=r_2=r_3=8.51 \Omega$  assuming that the Quality factor of the coils is 500, the self-inductance of Coils is  $L_1=L_2=L_3=99.93 \mu\text{H}$  and the resonant capacitance are  $C_1=C_2=C_3=5.51 \text{ pF}$ .

The load resistance is the optimal load resistance which maximizes the power transfer efficiency. The optimal load resistance which maximizes the transfer efficiency of the conventional WPT system with paired single transmitter and receiver coil and the power transfer efficiency are given as:

$$R_{L\_OPT\_Conventional} = \sqrt{r_3 \left( \frac{(M_{13}\omega)^2}{r_1} + r_3 \right)} \quad (29)$$

$$\eta_{conventional} = \frac{(\omega M_{13})^2 R_L}{(r_3 + R_L) \{ r_1 r_3 + r_1 R_L + (\omega M_{13})^2 \}} \quad (30)$$

For detail about the deviation of these equations refer to [8].

C. Calculation of Efficiency

Fig. 6 shows the calculated results of the power transfer efficiency. The solid line shows the power transfer efficiency of 2-D omni-directional MRC-WPT system with two orthogonal transmitter coils controlling the exciting voltage, and the dashed line shows the efficiency of the conventional one-directional MRC-WPT system with paired single transmitter and receiver coil. In the all range of the rotation angle, the efficiency of the proposal WPT system is higher than the efficiency of the conventional WPT system and even if the rotation angle is 90 degree the proposal WPT system can transfer the power.

TABLE I  
CIRCUIT PARAMETERS

Operating Frequency	$f_s$	6.78 MHz
Self-Inductance	$L_1=L_2=L_3$	99.93 $\mu$ H
Resonant capacitance	$C_1=C_2=C_3$	5.51 pf
Resistance of Coil	$r_1=r_2=r_3$	8.51 $\Omega$
Roald Resistance	$R_{L\_}$	$R_{L\_OPT}$
Distance	$d$	0.25m
Diameter of Coil	$D$	0.20m
Rotation Angle	$\theta$	0~90 degree

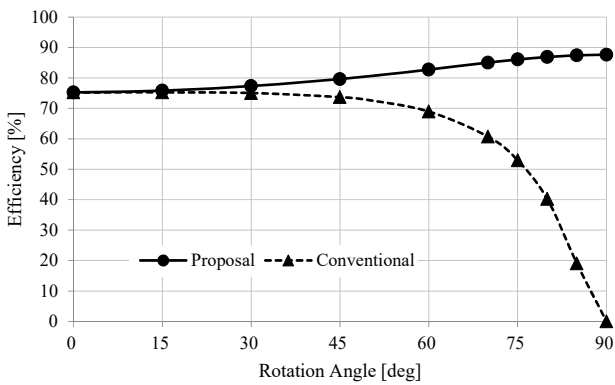

Fig. 6 Efficiency versus rotation angle

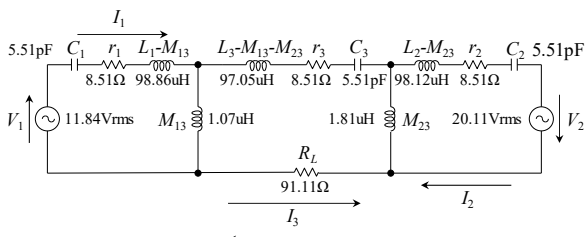

Fig. 7 Equivalent circuit for simulation analysis

V. VERIFICATION BY SIMULATION

We verify the validity of the deviated equations by the circuit simulation of the proposal WPT system with the rotation angle set at 60 degree. Fig. 7 shows the equivalent circuit for the simulation analysis and Table II shows the circuit parameters. The rate of mutual inductance  $K_M$  and the rate of the driving voltage is 1.70 given by the analysis result of the coupling

coefficient shown in Fig. 5. The optimal load resistance is 90.11 $\Omega$  calculated by using (28). The driving voltage  $V_1$  is 11.84V calculated by using (19).

Fig. 8 shows the simulation analysis results of the waveforms. The power factor of the input power is 1, this can confirms that T-type equivalent circuit is constituted by resistance and voltage source. The phase of the output waveforms is delayed 90 degrees from the phase of the input waveforms; this can confirm (15). Table III shows RMS values of waveforms, these results can confirm the validity of the deviated equations.

TABLE II  
CIRCUIT PARAMETERS

Parameter		Value
Operating Frequency	$f_s$	6.78MHz
Self-Inductance	$L_1=L_2=L_3$	99.93 $\mu$ H
Resonant capacitance	$C_1=C_2=C_3$	5.51 pf
Resistance of Coil	$r_1=r_2=r_3$	8.51 $\Omega$
Roald Resistance	$R_L$	91.11 $\Omega$
Distance	$d$	0.25m
Diameter of Coil	$D$	0.20m
Rotation Angle	$\theta$	60degree
Mutual Inductance	$M_{13}$	1.07 $\mu$ H
	$M_{23}$	1.81 $\mu$ H
Rate of Mutual Inductance	$K_M$	1.70
Rate of Exciting Voltage	$K_V$	1.70
Driving Voltage	$V_1$	11.84V
	$V_2$	20.11V

TABLE III  
ANALYSIS RESULTS

	Calculated	Simulated
Input Current	$I_1$	131.4mArms
	$I_2$	223.7Arms
Output Current	$I_3$	235.6mArms
Output Voltage	$V_o$	21.2Vrms

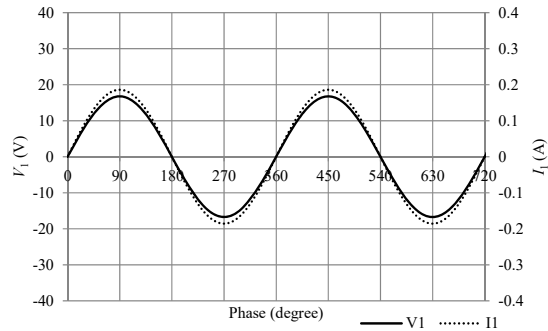

(a)  $I_1$  and  $V_1$  (Input waveforms)

(b)  $I_2$  and  $V_2$  (Input waveforms)(c)  $I_3$  and  $V_o$  (Output waveforms)

Fig. 8 Operating waveforms

## VI. CONCLUSION

In this paper, the theoretical power transfer efficiency formula of 2-D omni-directional MRC-WPT system with two orthogonal transmitter coils is derived by deriving the T-type equivalent circuit. And the exciting voltage control method for maximizing the power transfer efficiency is proposed by analyzing the T-type equivalent circuit. The exciting voltage control in 2-D omni-directional MRC-WPT system can realize a higher power transfer efficiency MRC-WPT system than one directional MRC-WPT system.

## REFERENCES

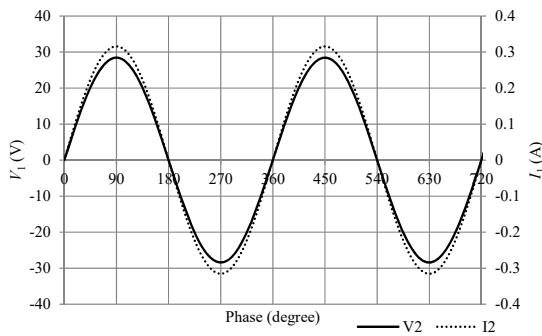
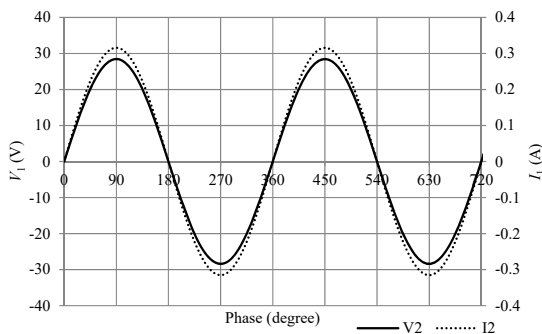
- [1] A. Kurs, A. Karalis, R. Moffat, J. D. Jonopoulos and M. Soljačić, "Wireless Power Transfer via Strongly Coupled Magnetic Resonances", in *Science Express*, Vol.317, No.5834, pp.83-86 (2007).
- [2] A. Karalis, J. D. Jonopoulos and M. Soljačić, "Efficient wireless non-radiative mid-range energy transfer", *Annals of Physics*, Vol.323, No.1, pp.34-48 (2008).
- [3] Q. Chen, L. Li, and K. Sawaya, "Numerical Analysis on Transmission Efficiency of Evanescent Resonant Coupling Wireless Power Transfer System", *IEEE Trans. Antennas Propag.*, Vol.58, No.5, pp.1751-1758 (2010).
- [4] T. Koyama, K. Umetani and E. Hiraki, "Optimization of the output power in a magnetic coupling wireless power transfer systems with dual resonators", The papers of Technical Meeting on "Electron Devices" and "Semiconductor Power Converter", IEE Japan, pp.79-84(2015) (in Japanese).
- [5] D. Lin, C. Zhang and S. Y. R. Hui, "Power and efficiency of 2-D omni-directional wireless power transfer systems", *Energy Conversion Congress and Exposition (ECCE)*, 2015 IEEE, pp.4951-4958 (2015).
- [6] D. Lin, S. Y. R. Hui and C. Zhang, "Omni-directional wireless power transfer systems using discrete magnetic field vector control", *Energy Conversion Congress and Exposition (ECCE)*, 2015 IEEE, pp.3203-3208 (2015).

- [7] N. Ha-Van and C. Seo, "A novel cubic transmitter for multi-directional wireless power transfer", *Wireless Power Transfer Conference (WPTC)*, 2015 IEEE, pp.1 - 3 (2015).
- [8] M. Kato, T. Imura, and Y. Hori, "New Characteristics Analysis Considering Transmission Distance and Load Variation in Wireless Power Transfer via Magnetic Resonant Coupling", *Proc. INTELEC2012*, pp.1-5 (2012).