

# Design of Reconfigurable 2 Way Wilkinson Power Divider for WLAN Applications

G. Kalpanadevi, S. Ravimaran, M. Shanmugapriya

**Abstract**—A Reconfigurable Wilkinson power divider is proposed in this paper. In existing system only a limited number of bandwidth is used at the output ports, in the proposed Wilkinson power divider different band of frequencies are obtained by using PIN diode. By tuning the PIN diode, different frequencies are achieved. The size of the power divider is reduced for the operating frequency and increases the fractional bandwidth.

**Keywords**—Isolation loss, PIN diode, Reconfigurable Wilkinson power divider and WLAN applications.

## I. INTRODUCTION

**P**OWER divider is a passive microwave component used for both power division and power combining. Both equal and unequal power division with arbitrary ratios are also possible. It is frequently used in microwave and millimeter-wave circuits such as feeding network for phased-array antenna, power amplifiers, etc. It is widely used in mixers, balanced amplifiers; RF transmitters & receivers, phase shifters, signal separation in telephone lines, transmission line fault testing, intermodulation distortion measurements, diversity gain measurements, antenna beam forming networks, etc. There are three types of power divider namely T-junction power divider, Resistive power divider and Wilkinson power divider. For perfect matching and for high isolation between output ports, Wilkinson power divider is extensively used. The Wilkinson power divider has high power handling capability and realizing good thermal performance.

The dual band reconfigurable power divider for WLAN applications employs two dual band quadrature hybrids connected through two dual band phase shifters. Each dual band phase shifter consists of two Diplexers and two switched line phase shifters operating at the lower and higher WLAN frequency bands [1].

A reconfigurable 1:4 power divider which operates at 2.45 GHz has four power transmission states. The insertion loss is affected by the amount of current flowing into the switch, and the current is determined by the switch state and the amount of reflection current in the junction [2], [5].

G.Kalpanadevi is with Department of Electronics and Communication Engineering, M.A.M. College of Engineering., Trichy – 621 105, India (Phone: 9443780910; e-mail: gkdmamce@gmail.com).

Dr. S. Ravimaran is with Department of Computer Science and Engineering, M.A.M. College of Engineering, Trichy – 621 105, India (Phone: 9443076222; e-mail: ssg\_ravimaran@mamce.org).

Dr. M. Shanmugapriya is with Department of Electronics and Communication Engineering, M.A.M. College of Engineering., Trichy – 621 105, India (Phone: 9443633367; e-mail: ssg\_priya@mamce.org).

A reconfigurable 1:3 power divider use quarter-wave long coupled lines and switches. It allows dual operating mode by turning the switches on and off. To make a high power-division ratio of three realizable and to improve the bandwidth, a microstrip-slot structure is adopted on a thick substrate with high dielectric constant. It works in a very narrow band [3], [7], [11].

The couple-line coupler has control switches at the coupled and the isolated ports offer several different operating conditions depending on the states of the switches. The input power is either equally divided into two output ports or delivered to the one output port exclusively [4], [8], [12]. A novel reconfigurable Wilkinson power divider with a minimum number of switches offer better bandwidth.

Defected Microstrip Structure has been used to increase the hybrid's phase matching [6], [10]. Power divider is formed by installing three open stubs and two aperture-backed interdigital coupled-lines to the traditional two-section Wilkinson power divider to get good impedance matching [9].

In this paper, it is proposed to design a reconfigurable Wilkinson power divider using PIN diode. It achieves power dividing ratio of different frequencies. By varying the biasing voltages for diode, various frequencies are achieved. And also the size of the power divider is reduced by using PIN diode.

## II. DESIGN AND ANALYSIS

Generally, the Wilkinson power divider is constructed using two quarter wave transmission lines which exhibit degrees of limitation such as relatively narrow band. On the other hand, nowadays, the rapid increase of wireless communication leads to a great demand in designing compact, low cost and dual-band components. Recently, various techniques have been used to design dual-band Wilkinson power divider. In this system a reconfigurable 3dB Wilkinson power divider is designed with the operating frequency range of 1.9GHz to 2.4 GHz. To avoid interference between its output ports an isolation resistor is properly placed between its output ports. The effective dielectric constant is a function of the relative permittivity of the substrate, the substrate thickness, and the conductor width. It can be approximately determined by (1):

$$\epsilon_{eff} = \frac{\epsilon_r + 1}{2} + \frac{\epsilon_r - 1}{2} * \left( \frac{1}{\sqrt{1 + 12D/W}} \right) \quad (1)$$

The effective dielectric constant can be interpreted as the dielectric constant of a homogeneous medium that replaces the air and dielectric regions of the microstrip. The wavelength,

$\lambda_m$  (in millimeters) in the microstrip is related to the phase velocity and can be determined by (2):

$$\lambda_m = \frac{300}{F\sqrt{\epsilon_{eff}}} \quad (2)$$

where F is the intended frequency of operation in GHz. With the dimensions of the microstrip line, the characteristic impedance can be calculated as

$$Z_0 = \begin{cases} \frac{60}{\sqrt{\epsilon_e}} \ln\left(\frac{8D}{W} + \frac{W}{4D}\right) & \text{for } \frac{W}{D} \leq 1 \\ \frac{120\pi}{\sqrt{\epsilon_e} [W/D + 1.393 + 0.667 \ln(W/D + 1.444)]} & \text{for } \frac{W}{D} \geq 1 \end{cases} \quad (3)$$

The characteristic impedance ( $Z_0$ ) of a microstrip line is also related to the conductor width (W) and dielectric thickness (D). The  $Z_0$  of the microstrip line is determined by (3). More conveniently, the ratio of conductor width to dielectric thickness can be determined by (4) for giving characteristic impedance and its relative permittivity by:

$$\frac{W}{D} = \begin{cases} \frac{8e^A}{e^{2A}-2} & \text{for } \frac{W}{D} < 2 \\ \frac{2}{\pi} \left[ B - 1 - \ln(2B - 1) + \frac{\epsilon_r - 1}{2\epsilon_r} \left\{ \ln(B - 1) + 0.39 - \frac{0.61}{\epsilon_r} \right\} \right] & \text{for } \frac{W}{D} > 2 \end{cases} \quad (4)$$

where

$$A = \frac{Z_0}{60} \sqrt{\frac{\epsilon_r + 1}{2}} + \frac{\epsilon_r - 1}{\epsilon_r + 1} \left( 0.23 + \frac{0.11}{\epsilon_r} \right) \quad (5)$$

$$B = \frac{377\pi}{2Z_0\sqrt{\epsilon_r}} \quad (6)$$

The width of the microstrip line is calculated by (7):

$$W = \text{calculated value} * D \quad (7)$$

The length of microstrip line is given by (8)

$$l = \frac{90^\circ(\pi/180^\circ)}{\sqrt{\epsilon_e} K_0} \quad (8)$$

where  $K_0 = \frac{2\pi f}{c}$  is the value which relates the length and the resonant frequency of the power divider.

From the calculated values, the reconfigurable power divider is designed. The structure of the reconfigurable power divider is shown in Fig. 1.

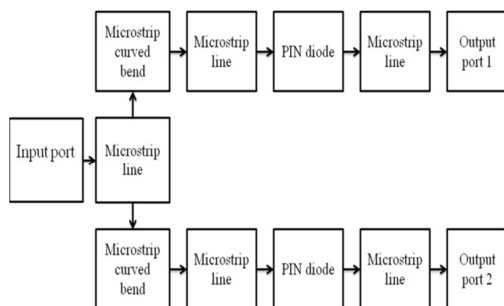

Fig. 1 Block diagram of reconfigurable power divider

A PIN diode is a semi-conductor device which acts as a variable resistor at RF and microwave frequencies. When the forward bias control current of the PIN diode is varied continuously, it can be used for attenuating, leveling, and amplitude modulating an RF signal. When the control current is switched on and off, or in discrete steps, the device can be used for switching, pulse modulating, and phase shifting an RF signal. The microwave PIN diode's has a small physical size compared to a wavelength, high switching speed, and low package parasitic resistance. It is an ideal component for use in miniature, broadband RF signal control circuits. In addition, the PIN diode has the ability to control large RF signal power while using much smaller levels of control power. From the reverse bias operation of the PIN diode the reconfigurable power divider will act as the power combiner.

The use of PIN diodes as the switching element in microwave circuits is based on the difference between the PIN diode reverse and forward bias characteristics. At lower microwave frequencies less than 2 GHz, the PIN diode appears to be very small impedance under forward bias and very large impedance under reverse bias. It is the difference in performance between forward and reverse bias states upon which switch operation relies. The proper biasing is provided to tune the power divider resonant frequency.

### III. SIMULATED AND MEASURED RESULTS

The design of reconfigurable microstrip Wilkinson power divider is constructed using one input and two output ports which are terminated by 50 ohm impedance. The frequency of the power divider is depending upon the length of the microstrip line. Varying the length of the microstrip line will increase the frequency.

The FR4 substrate has the dielectric constant of 4.4 and height of 1.6 millimeter. The proposed reconfigurable 3dB Wilkinson power divider is designed for GSM and Wireless applications and shown in Fig. 2. The Wilkinson power divider is designed by using ADS (Advanced Design System) simulation tool.

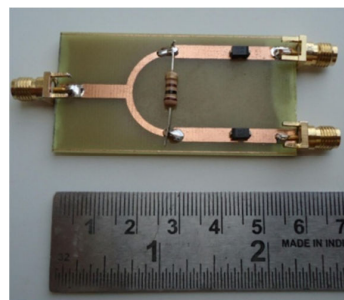

Fig. 2 Fabricated model of reconfigurable power divider

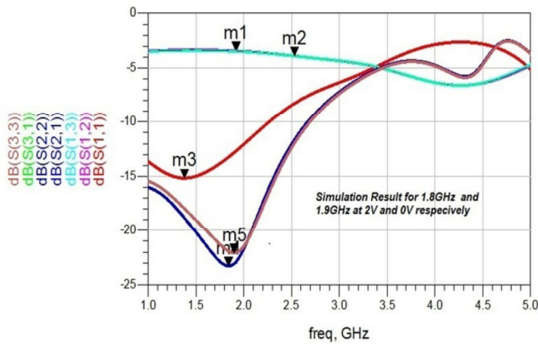

Fig. 3 (a) Simulation result for 2V and 0V biasing operates that at 1.8 GHz and 1.9 GHz

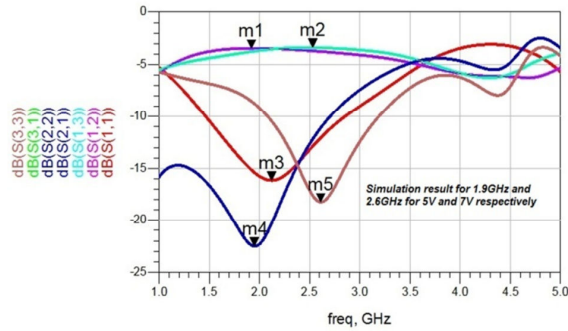

Fig. 3 (c) Simulation result for 5V and 7V biasing operates that at 1.9 GHz and 2.6GHz

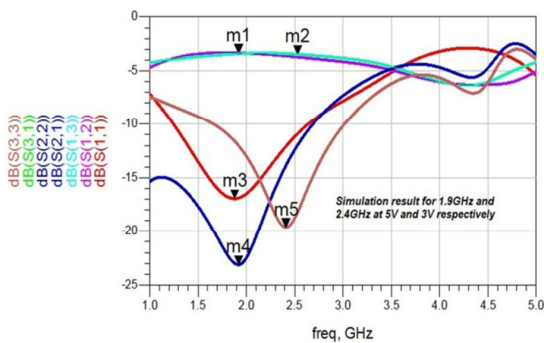

Fig. 3 (b) Simulation result for 5V and 3V biasing operates that at 1.9 GHz and 2.4GHz

The operation of the PIN diode is enabling to tune the frequency range from 1.8 GHz to 2.6 GHz. The power is equally delivered at two output ports. When the biasing voltage of 2 volts is applied to diode 1 and 0 volts is applied to diode2, the port 2 is operated at 1.8 GHz and port 3 is operated at 1.9 GHz respectively and the simulated result is shown in Fig. 3 (a). When the biasing voltage of 5 volts is applied to diode1 and 3 volts is applied to diode2, the port 2 is operated at 1.9 GHz and port 3 is operated at 2.4 GHz respectively and the simulated result is shown in Fig. 3 (b). Similarly, when the biasing voltage of 5 volts is applied to diode 1 and 7 volts is applied to diode2, the port 2 is operated at 1.9 GHz and port 3 is operated at 2.6 GHz respectively and the simulated result is shown in Fig. 3 (c). The corresponding voltage levels and its resonant frequency are tabulated in Table I.

The measurement result shows that the proposed reconfigurable Wilkinson power divider has the better input return loss of -29.8dB and output return loss of -27.75 dB for the operating frequency of 2.6GHz and 1.9GHz respectively as shown in Figs. 4 (a) and (b).

TABLE I  
BIASING VOLTAGE AND ITS RESONANT FREQUENCIES

Biasing for Diode1	Biasing for Diode2	Port 2 frequency	Port 3 frequency	Applications
0 Volt	0 Volt	2.2 GHz	2.2 GHz	3G Std UMTS, W-CDMA, TD-SCDMA and CDMA 2000
2 Volt	0 Volt	1.8 GHz	1.9 GHz	TDMA, CDMA, GSM, GPRS.
5 Volt	3 Volt	1.9 GHz	2.4 GHz	Bluetooth and WI-FI
5 Volt	7 Volt	1.9 GHz	2.6 GHz	WI-FI and Wi-MAX
5 Volt	13 Volt	1.8 GHz	1.8 GHz	Mobile applications and Satellite Uplink



Fig. 4 (a) Measured result of input return loss at the frequency of 2.6GHz



Fig. 4 (b) Measured result of output return loss at the frequency of 1.9 GHz

The measurement result shows that the proposed reconfigurable Wilkinson power divider has better return loss of greater than -10dB, better isolation, loss of greater than -18dB and good insertion loss of -3dB.

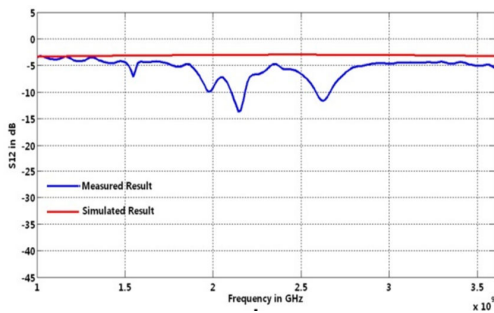

Fig. 5 (a) Simulated Vs Measured result for insertion loss  $S_{12}$  of -3dB

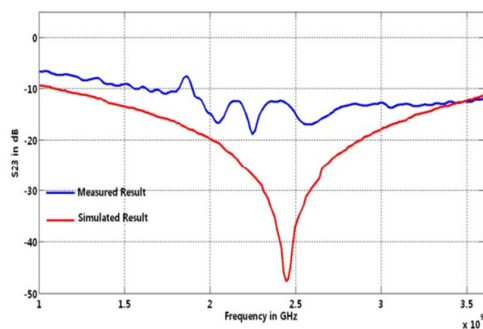

Fig. 5 (b) Simulated Vs Measured result for isolation loss  $S_{23}$  at 2.4GHz

Figs. 5 (a) and (b) show the comparison result between simulation and measurement techniques. It shows that the proposed reconfigurable Wilkinson power divider has a better agreement between simulation and measurement results. Some deviations in simulation and measured results occur due to fabrication effect and connector losses.

#### IV. CONCLUSION

The reconfigurable 3dB Wilkinson power divider has been designed for the frequency range from 1.8GHz to 2.6GHz by using PIN diode. The Bandwidth is 800MHz. The proposed structure has a dimension of 5.8cm x 2.8cm. The calculated  $\lambda_m$  value for 1.8GHz frequency is 7.9cm. This reconfigurable Wilkinson power divider has 36% size reduction compared to the conventional power divider. The proposed Wilkinson power divider has input return loss of -29dB and output return loss of -27dB. There is a good agreement between simulation results and measured results. The results show that the proposed power divider has better return loss and isolation loss.

#### REFERENCES

[1] R. Vincenti Gatti, A. Ocera, L. Marcaccioli and R. Sorrentino. "A Dual Band Reconfigurable Power Divider for WLAN Applications", *IEEE Microwave Symposium Digest*, pp 465-468, June 2006.

- [2] Hyun-Sung Tae, Kyoung-Sub Oh, Han-Lim Lee, Wang-Ik Son, and Jong-Won Yu. "Reconfigurable 1: 4 Power Divider with Switched Impedance Matching Circuits" *IEEE microwave and wireless components letters*, vol. 22, no. 2, pp 64-66, February 2012.
- [3] S. Kim and J. Jeong "Reconfigurable 1:3 power divider using coupled lines", *Electronics Letter*, vol. 45, issue 22, pp 1141-1143, October 2009.
- [4] Ki Tae Kim, Younkyu Chung, Jung Hoon Kang, Tatsuo Itoh, and Dal Ahn, "Reconfigurable Power Divider and Combiner with Variable Power Ratio", *Microwave Symposium Digest*, vol. 1, pp 6-11, June 2004.
- [5] T. Lehmann, F. Hettstedt and R. Knoechel, "Reconfigurable Wilkinson power dividers with minimum number of switches", *Electronics Letter*, vol. 45, issue 2, pp 111-112, January 2009.
- [6] M. Fartookzadeh, S. H. Mohseni Armaki, and M. Kazerooni, "A Novel 180± hybrid based on the modified gysel power divider" *Progress In Electromagnetics Research C*, vol. 27, pp 209-222, 2012.
- [7] J. C. Li, Y. L. Wu, Y. A. Liu, J. Y. Shen, S. L. Li, and C. P. Yu, "A Generalized Coupled-Line Dual-Band Wilkinson Power Divider with Extended Ports," *Progress In Electromagnetics Research*, vol. 129, pp 197-214, 2012.
- [8] A. M. El-Tager, A. M. El-Akhdar, H. M. El-Hennawy, "Analysis of coupled microstrip lines for quad-band equal power dividers/combiners", *Progress In Electromagnetics Research B*, vol. 41, pp 187-211, 2012.
- [9] Wei-Qiang Liu, Feng Wei, Chun-Hui Pang, Xiao-Wei Shi," Design of a Compact Ultra-Wideband Power Divider", *International Conference on Microwave and Millimeter wave Technology*, vol. 2, pp 5-8, May 2012.
- [10] H. Zhang, X. Shi, F. Wei, and L. Xu, "Compact wideband Gysel power divider with arbitrary power division based on patch type structure ", *Progress In Electromagnetics Research*, vol. 119, pp 395-406, 2011.
- [11] B. Li, X. Wu, N. Yang, and W. Wu," Dual-band Equal/Unequal Wilkinson Power Dividers Based On Coupled-line Section With Short-circuited Stub," *Progress In Electromagnetics Research*, vol. 111, pp 163-178, 2011.
- [12] Yongle Wu, Yuanan Liu, Quan Xue, "An Analytical Approach For A Novel Coupled-line Dual-band Wilkinson Power Divider", *IEEE Transactions On Microwave Theory And Techniques*, vol. 59, issue 2, pp 286-294, February 2011.

**G. Kalpanadevi** has received her B.E in Electronics and Communication Engineering from Bharathidasan University, Trichirappalli, Tamil Nadu, India in 2003 and completed a Master Degree in Communication Systems from Anna University, Chennai, Tamil Nadu, India in 2011. Since 2013, she has been a research scholar, pursuing a PhD at Anna University, Chennai, Tamil Nadu; India. Now she is working as Associate Professor in the department of Electronics and Communication Engineering, M.A.M. College of Engineering, Trichirappalli, Tamil Nadu, India. Her main research interests are design and development of Microstrip power divider and combiner. She is member of IE (I).

**Dr.S. Ravimaran**, Principal and Professor in Computer Science and Engineering department of the M.A.M. College of Engineering, Tamil Nadu, India and he has received his B.E. in computer science and engineering from National Institute of Technology, Tiruchirappalli, India in 1997 and his M.E. Computer science and engineering from Anna University, Chennai, Tamil Nadu, India in 2004. He has done his Ph.D. in Data and Transaction Management Using Surrogate Objects in Distributed Mobile Systems from Anna University Chennai, India in 2013. The Thesis was duly evaluated by the foreign and Indian examiners and both the examiners had unanimously recommended the *thesis* work as "Highly Commended". He has 24 years of experience in academics and research. He is an active member of computer society of India and holding the post of chairman – computer society of India, Tiruchirappalli chapter since April 2015. He has published 13 technical papers in national and international journals and currently he has guided 11 PhD scholars. His research interests are distributed System, cloud Mining, mobile Cloud and Utility mining.

**Dr. M. Shanmugapriya** has received her B.E in Electronics and Communication Engineering from Bharathidasan University, Trichirappalli, Tamil Nadu, India in 1996 and completed a Master Degree in Communication

Systems from Anna University, Chennai, Tamil Nadu, India in 2005. She has done his Ph.D. in Design and development of miniaturized Antenna for WSN applications from Anna University Chennai, India in 2015. Now she is working as Professor in the department of Electronics and Communication Engineering, M.A.M. College of Engineering, Trichirappalli, Tamil Nadu, India. Her main research interests are design and development of Microstrip Antenna. She is member of IE (I).