

Design of a Robust Controller for AGC with Combined Intelligence Techniques

R. N. Patel, S. K. Sinha, R. Prasad

Abstract—In this work Artificial Intelligence (AI) techniques like Fuzzy logic, Genetic Algorithms and Particle Swarm Optimization have been used to improve the performance of the Automatic Generation Control (AGC) system. Instead of applying Genetic Algorithms and Particle swarm optimization independently for optimizing the parameters of the conventional AGC with PI controller, an intelligent tuned Fuzzy logic controller (acting as the secondary controller in the AGC system) has been designed. The controller gives an improved dynamic performance for both hydrothermal and thermal-thermal power systems under a variety of operating conditions.

Keywords—Artificial intelligence, Automatic generation control, Fuzzy control, Genetic Algorithm, Particle swarm optimization, Power systems.

I. INTRODUCTION

A modern power system network consists of a number of utilities interconnected together and power is exchanged between utilities over tie line by which they are interconnected. An electrical power system must be maintained at a desired operating level characterized by nominal frequency, voltage profile and load flow conditions. It is kept in its nominal state by close control of real and reactive powers generated by the controllable sources in the system. Due to the inherent characteristics of changing loads, the operating point of power system may change very much during a daily cycle. The generation changes must be made to match the load perturbation at the nominal conditions, if the normal state is to be maintained [1].

The mismatch in the real power balance affects primarily the system frequency but leaves the bus voltage magnitude essentially unaffected. In a power system, it is desirable to achieve better frequency constancy than obtained by the speed governing system alone. This requires that each area should take care of its own load changes, such that schedule tie power can be maintained. The problem of controlling the real power

output of electric generators in this way is termed as Automatic Generation Control (AGC). AGC is summarily defined as: “The regulation of the power output of electric generators within a prescribed area in response to changes in system frequency and/or tie line loading, or the relation of these two with each other, so as to maintain the schedule system frequency and/or the established interchange with other areas within predetermined limits” [2].

The operating point of the power system changes in a daily cycle due to the inherent nature of the changing load. This poses the difficulty in optimizing the conventional controller gains. Thus it may fail to provide the best dynamic response. The growth in size and complexity of electric power systems along with increase in power demand has necessitated the use of intelligent systems that combine knowledge, techniques and methodologies from various sources for the real-time control of power systems [1-7]. In practice different conventional control strategies are being used for AGC. Yet, the limitations of conventional PI and PID controllers are: slow and lack of efficiency and poor handling of system nonlinearities. Artificial Intelligence techniques like Fuzzy Logic, Artificial Neural networks, Genetic Algorithms (GA) and Particle Swarm Optimization (PSO) can be applied for automatic generation control, which can overcome the limitations of conventional controls as PID control [8-10]. Table-I gives the different aspects/applications in a controller design that can be effectively handled by various AI techniques. In addition, we can use the AI techniques in combination (e.g. PSO tuned Fuzzy controller or GA tuned Fuzzy controller) to take advantages of more than one technique in a single controller.

Section II gives the basic principles of GA and PSO for parameter tuning applications and also introduces the concept of ‘Combined Intelligence’. Section III gives the selection of tunable parameters in a Fuzzy controller and the basis of parameter tuning. Section IV gives the simulation model and the comparison of results for both hydrothermal and thermal-thermal two area power systems. The relative performance of GA tuning and PSO tuning have been compared. The last section gives the concluding remarks.

Manuscript received June 12, 2008. This work was supported by the Department of Science and Technology, Govt. of India through the FAST TRACK Project for young scientists vide the Grant no. SR/FTP/ETA-03/2005.

R. N. Patel is with the Department of Electrical and Electronics Engineering, Shri Shankaracharya College of Engineering and Technology, Junwani, PO- Nehru Nagar, Bhilai (C.G.) 490 020, India. (phone: 91-788-2291605; fax: 91-788-2291606; e-mail: ramnpatel@gmail.com).

S. K. Sinha is a faculty in the Department of Electrical Engineering at College of Engineering Roorkee, Roorkee, India.

R. Prasad is Associate Professor in the Department of Electrical Engineering at IIT Roorkee, India, (e-mail: rpdeefee@iitr.ernet.in).

TABLE I
APPLICATION OF VARIOUS INTELLIGENT SYSTEMS

Application	Fuzzy systems	ANNs	GA	PSO
Optimization problems			**	**
Predictions		**		
Control Applications	**			

II. APPLICATION OF COMBINED INTELLIGENCE TECHNIQUES

The genetic algorithm (GA) and particle swarm optimization (PSO) are the two very effective methods for problems related to optimization of non-linear objective functions [11-13]. Both of these algorithms search from many points in the search space at once and yet continually narrow the focus of the search to the areas of the observed best performance. These algorithms can be applied to solve a variety of optimization problems that are not well-suited for standard optimization algorithms, including problems in which the objective function is discontinuous, non-differentiable, stochastic, or highly nonlinear [13].

The genetic algorithm is a global search technique for solving optimization problems, which is essentially based on the theory of natural selection, the process that drives biological evolution. The flowchart in Fig.1 explains the process in brief.

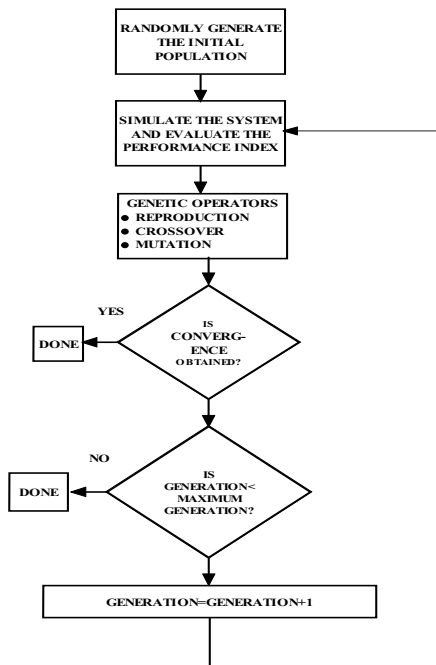

Fig. 1 Flow chart of genetic algorithm

Particle swarm optimization (PSO) is a population based stochastic optimization technique inspired by social behavior of bird flocking or fish schooling. The system is initialized with a population of random solutions and searches for optima by updating generations. In PSO, the potential solutions, called particles, fly through the problem space by following the current optimum particles. In PSO technique, each individual adjusts its flying according to its own flying experience and its companion's flying experience. Each particle keeps track of its coordinates in the problem space which are associated with the best solution (fitness) it has achieved so far. This value is called 'pbest'. Another "best"

value that is tracked by the particle swarm optimizer is the best value, obtained so far by any particle in the population. This best value is a global best and called 'gbest'. The flowchart given in Fig. 2 explains the process.

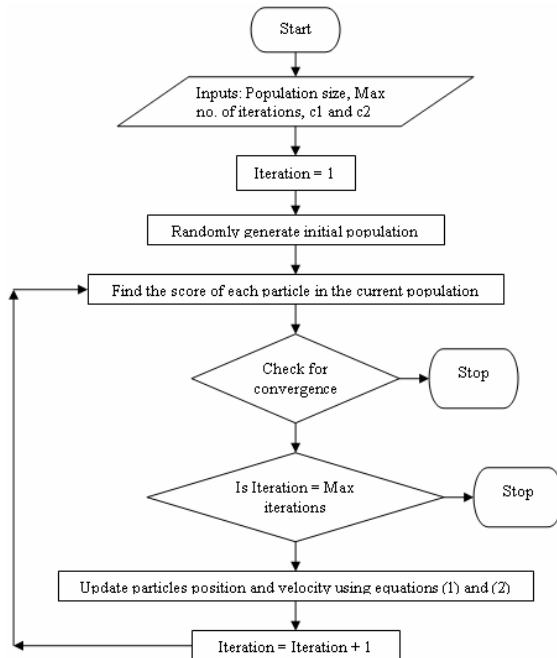

Fig. 2 Flow chart of particle swarm optimization

The following equations give the present velocity and position vectors:

$$v[] = v[] + c1 * \text{rand}() * (\text{pbest}[] - \text{present}[]) + c2 * \text{rand}() * (\text{gbest}[] - \text{present}[]) \quad (1)$$

$$\text{present}[] = \text{present}[] + v[] \quad (2)$$

Where, $v[]$ = particle velocity,

$\text{present}[]$ = current particle (solution),

$\text{rand}()$ = random number between (0,1),

$c1, c2$ are learning factors, usually $c1 = c2 = 2$

and $\text{pbest}[]$ and $\text{gbest}[]$ are defined as discussed earlier.

Artificial Intelligence Techniques like Fuzzy logic, Genetic Algorithms and Particle Swarm Optimization have been used to improve the performance of the Automatic Generation Control system [1-2]. Instead of applying Genetic Algorithms and Particle swarm optimization independently for optimizing the parameters of the Automatic Generation Control (AGC) system and Fuzzy logic controller (acting as the secondary controller in the AGC system), we can use the those techniques in combination (e.g. PSO tuned Fuzzy controller or GA tuned Fuzzy controller) to tap in the advantages of both the Artificial Intelligence techniques [12]. The main objectives of the work thus are:

- (a) To consider interconnected hydrothermal system and Thermal-thermal systems in which the fuzzy logic controller (FLC) is used.
- (b) To examine tunable parameters of the FLC in order to get optimal dynamic response of the systems considered above.
- (c) To optimize the tunable parameters with Artificial intelligence techniques such as GA and PSO.
- (d) To evaluate the dynamic responses of the two systems with optimized FLC considering load disturbances and to compare them with those obtained with the conventional PI and Fuzzy controllers.

III. INTELLIGENT TUNING OF FUZZY LOGIC CONTROLLER

Fuzzy logic controller (FLC) can be described by five different functional blocks, namely fuzzification, rule-base, data-base, inference engine, and de-fuzzification [14]. Since the inputs and the outputs of a fuzzy controller must be real numbers in order to match the sensors' and the actuators' requirements, fuzzification of input variables and de-fuzzification of output variables are necessary. The purpose of fuzzification is to transform the real sensor data into fuzzy linguistic terms so that further fuzzy inferences can be performed according to the rule-base. Commonly used set of fuzzy terms are shown in Fig. 3.

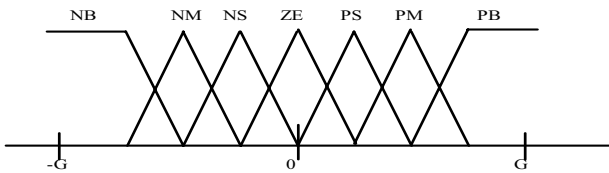

Fig. 3 membership functions of fuzzy terms

A. Scaling Factor Tuning

In order to simplify the notation, the fuzzy linguistic terms in the premise of the rules in the rule-base are sometimes defined within the range of [0, 1]. As a result, it is necessary to normalize the actual variations of the sensor inputs into the interval of [0, 1]. The input scaling factors, G^E and G^{CE} , are determined by the experts or designers so that the universe of discourse of the input variables are mapped into the unity interval as shown in Fig. 4.

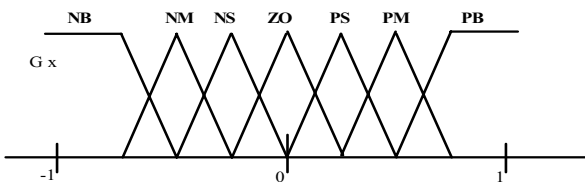

Fig. 4 Normalized linguistic terms

It can be easily seen that an input scaling factor of G^1 and a normalized set of linguistic terms are equivalent to a set of

linguistic terms with the universe of discourse between $\left[-\frac{1}{G_1}, \frac{1}{G_1} \right]$.

Now, the scaling factors G^E and G^{CE} are altered during the tuning process and become G_E^1 and G_{CE}^1 such that:

$$G_E^1 = K_E \times G^E \tag{3}$$

$$\text{And } G_{CE}^1 = K_{CE} \times G^{CE} \tag{4}$$

Where, K_E and K_{CE} the scaling factors.

Therefore, the fuzzy controller can be represented as shown in the Fig. 5.

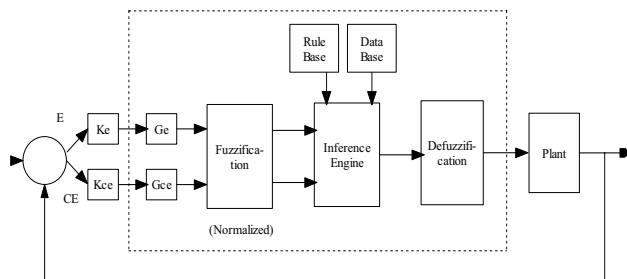

Fig. 5 Tuning parameters for input scaling factors

The input scaling factors are the coefficients between the universe of discourse of the input variables and the unity interval, in which are supposedly constant if the range of input variations, are approximately known. For an auto-tuning or learning controller design, most of the parameters are not known and the tuning of a set of parameters according to a learning scheme, such as the genetic algorithm, may be able to improve the system performance and derive a better controller.

B. Membership Function Width Tuning

The performance of the Fuzzy Logic controller depends on a designed knowledge base in which membership functions and fuzzy control rules are defined [14]. Consider a fuzzy variable with fuzzy sub sets like (NL, ZE, PL) which are formed by their membership functions. Once the shape and width and center position of the membership functions are chosen, they cannot be altered in the control process. As we change the membership function width, the output of the controller also varies. We can see in the Fig. 6 that the centers of the membership functions remain unaltered but the widths are altered and thus the membership function width is identified as one of the tunable parameters.

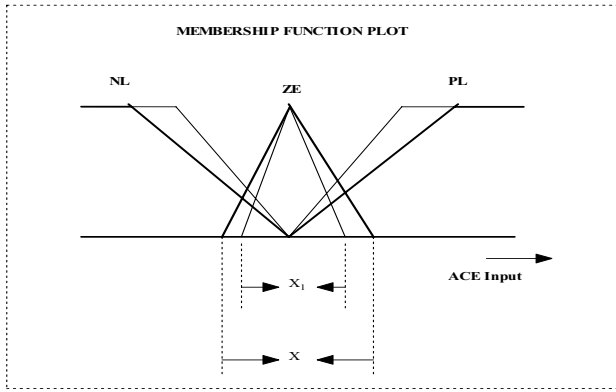

Fig. 6 Membership function width variation

In case of thermal-thermal system, the two thermal areas have the same parameters as that of the thermal area of the given hydrothermal system. The dynamic responses were obtained through simulation. Tuning of the proposed FLC has been done using both GA and PSO algorithms. Tables II and III give the optimized values of scaling factors using GA and PSO. Subsequently, the responses of the resultant intelligent controllers have been compared; the following notations have been used in the plots of the system responses:

- delf1 = change in frequency of Area-1.
- delf2 = change in frequency of Area-2.
- delp12 = change in tie line power.
- gat = GA tuned;
- psot = PSO tuned.

IV. ILLUSTRATIVE SYSTEM EXAMPLES AND RESULTS

Investigations have been carried out on an interconnected hydro-thermal and thermal-thermal power systems. Off-line simulation model has been developed using MATLAB® [15]. Fig. 7 shows the small perturbation transfer function model of a two-area hydrothermal system with the system data. Fig. 8 gives the structure of the Fuzzy logic controller, shown as 'Subsystem' and 'Subsystem1' in the main model of Fig. 7. The additional system data has been given in the appendix.

TABLE II
OPTIMIZED VALUES OF SCALING FACTORS USING GA

	System Investigated	x	y
Controller parameters not Optimized	Hydro thermal system	1	1
	Thermal-thermal System	1	1
Controller Parameters Optimized by GA	Hydro thermal system	4.222	10.200
	Thermal-thermal System	4.231	5.000

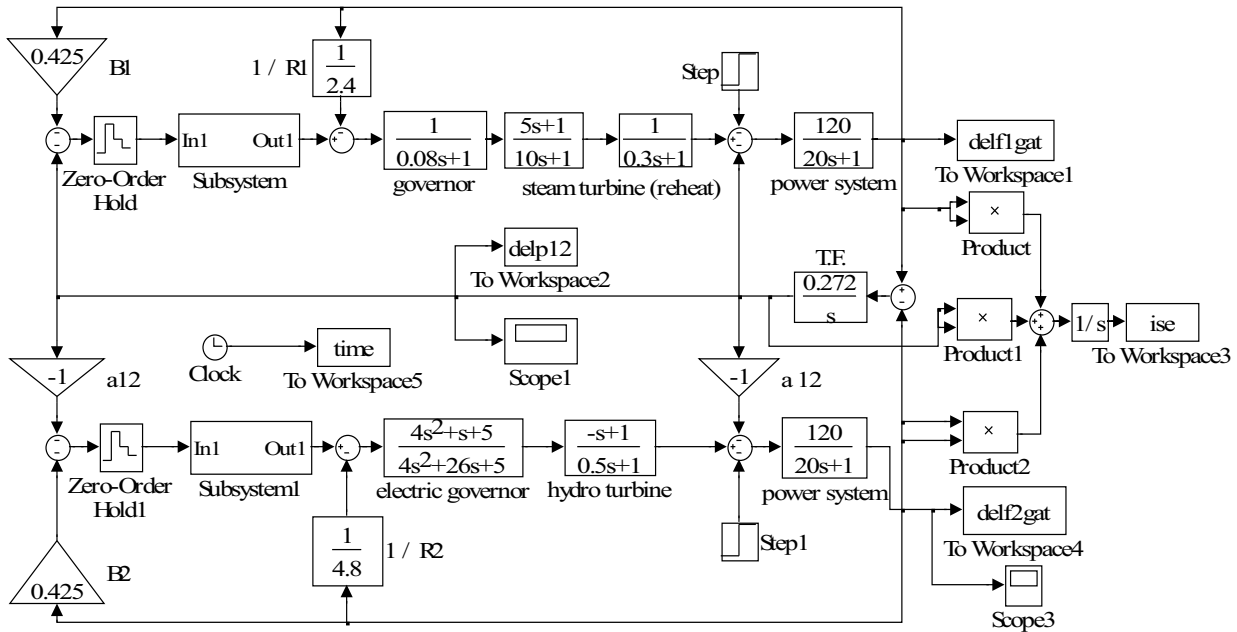

Fig. 7 MATLAB® model of the interconnected hydrothermal system

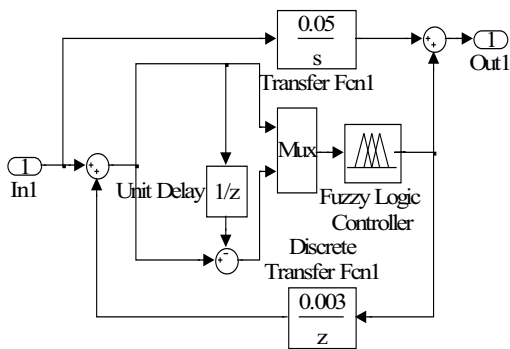

Fig. 8 Fuzzy controller within the ‘Subsystem’

TABLE III
OPTIMIZED VALUES OF SCALING FACTORS USING PSO

	System Investigated	x	y
Controller parameters not Optimized	Hydro thermal system	1	1
	Thermal-thermal System	1	1
Controller Parameters Optimized by PSO	Hydro thermal system	4.286	5.000
	Thermal-thermal System	4.312	4.522

A. Hydro Thermal System

The optimized controllers namely PSO tuned FLC and GA tuned FLC controllers have been tried out for AGC of a two area hydro-thermal system and thermal-thermal system. Figs. 9-12 show comparison of dynamic responses between modified FLC, PSO tuned FLC and GA tuned FLC considering 1% step perturbation in thermal area as well as in the hydro area, for a sampling period of 2 sec and with R=2.4 in thermal area and 4.8 in hydro area. Analyses of these responses clearly reveal that GA tuned FLC provides better dynamic responses compared to the other two. Presence of FLC in both areas guarantees zero steady state error; but GA tuned FLC provides less peak overshoot and the settling time is also less irrespective of the location of the perturbation in either area or in both the areas.

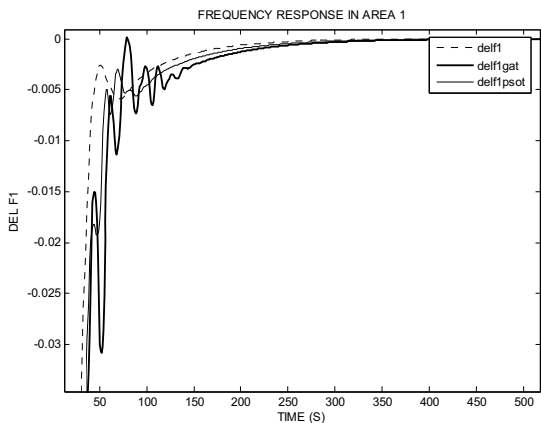

Fig. 9 Frequency response in area 1

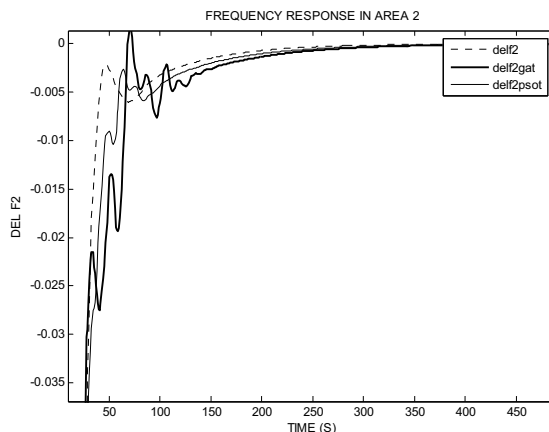

Fig. 10 Frequency response in area 2

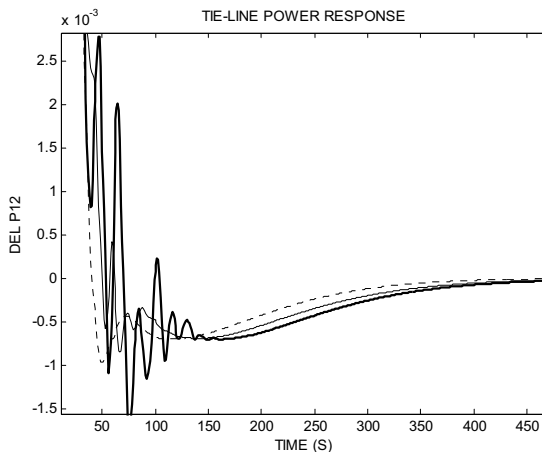

Fig. 11 Tie line power response

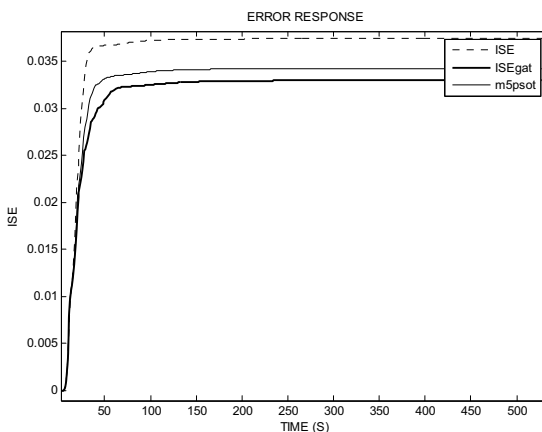

Fig. 12 Error response

B. Thermal-Thermal System

The optimized controllers namely PSO tuned FLC and GA tuned FLC have been examined for AGC of a two area thermal-thermal system. Figs. 13-15 show comparison of dynamic responses considering 1% step perturbation in both the areas for a sampling period of 2 seconds with $R=2.4$ in thermal area and 4.8 in hydro area. It was observed again that the GA tuned FLC gives better dynamic responses. Further, it was also observed that GA tuned FLC provides less peak overshoot and smaller value of settling time irrespective of the location of the perturbation in the control area. The measure of the performance is finally indicated by the error response (i.e. integral of square of errors abbreviated as 'ise') as shown in Fig. 15.

The robustness of the controller is also tested by studying its performance for different area capacities in both hydro and thermal interconnected systems, while the disturbances were considered in both the areas. Simulation results reveal that the intelligent tuned controller adjusts well to these variations in the system operating conditions, which are expected in the real world situation.

Summary of the useful observations from the observed results can be stated as under:

- (i) The effect of tunable parameters of Fuzzy controllers (in both the areas of a two area interconnected system) was studied in detail and the combined intelligence techniques were used for parameter tuning. By combined intelligence here we mean the GA tuned Fuzzy controller and PSO tuned Fuzzy controller. The tunable parameters were: Membership function width and the Scaling factor.
- (ii) The dynamic performance of a Fuzzy controller is better than a conventional PI controller in terms of ensuring a zero steady-state error in frequency and tie line power flow deviation. This is further enhanced by the parameter tuning by combined intelligence techniques.
- (iii) Out of the two tunable parameters of the Fuzzy logic controller, the scaling factor tuning proves to be more effective for obtaining the best dynamic response.
- (iv) Between the two tuning algorithms, GA tuning gives better performance compared to the PSO tuning. It was also observed that the GA optimized Fuzzy Logic Controller (where the parameter tuned is scaling factor) gives the best dynamic response even in case where load changes occur in both areas of a thermal-thermal and hydrothermal interconnected systems.
- (v) As the generating capacity of an area increases, the peak deviation (of frequency and tie flow) and the amplitude of oscillation increases and settling time almost remains constant or decreases slightly.
- (vi) As the capacity of the area increases, the speed regulation parameter 'R' of the hydro area (in case of a hydro-thermal system) needs to be increased to maintain system stability.
- (vii) The optimally tuned Fuzzy Logic Controller is well suited even for the situations where the change in area capacity effect comes into picture.

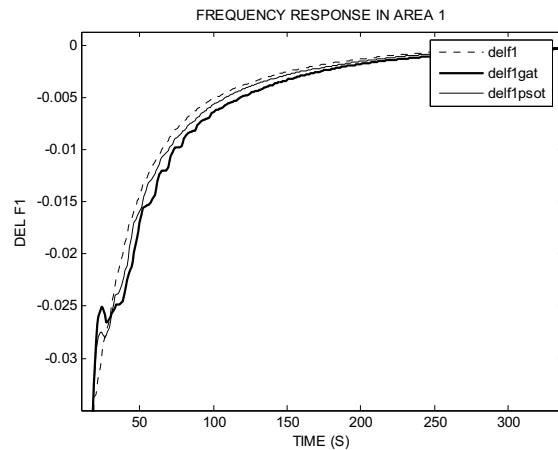

Fig. 13 Frequency response in area 1

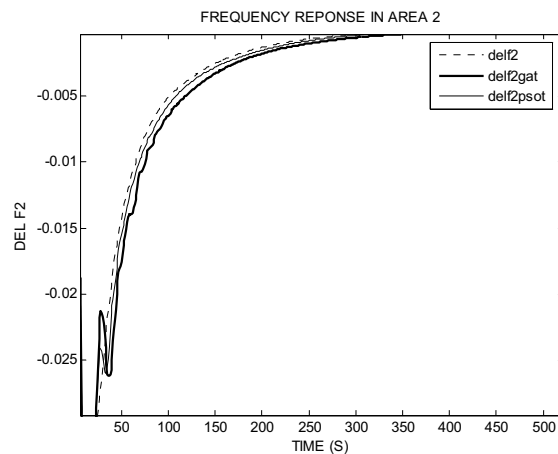

Fig. 14 Frequency response in area 2

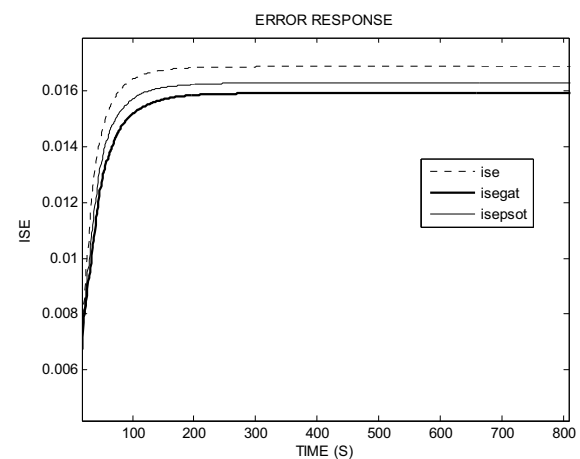

Fig. 15 Error response

V. CONCLUSIONS

Artificial Intelligence Techniques have been used either in designing of the new controllers (such as ANN or Fuzzy controllers) or for the tuning of the existing controllers (e.g. GA tuned or PSO tuned PI controllers) to improve the performance of the Automatic Generation Control systems. In the present work an innovative method of using both the above techniques simultaneously, termed as 'Combined intelligence technique', has been tried out. After the designing a Fuzzy controller, and ensuring that it performs better than a conventional PI controller; it has been tuned through GA and PSO to improve its dynamic performance further. This implementation proves to be successful for both thermal-thermal system and hydrothermal systems.

APPENDIX

NOMINAL PARAMETERS OF HYDROTHERMAL SYSTEM INVESTIGATED

$f = 60$ Hz	$D_1 = D_2 = 8.33 \times 10^{-3}$ p.u. MW/ Hz
$T_g = 0.08$ sec	$R_1 = R_2 = 2.4$ Hz/p.u. MW
$T_r = 10.0$ sec	$T_i = 0.3$ sec
$H_1 = H_2 = 5$ sec	$K_p = 1.0$
$P_{r1} = P_{r2} = 2000$ MW	$K_d = 4.0$
$P_{tie, max} = 200$ MW	$K_i = 5.0$
$K_r = 0.5$	$T_w = 1.0$ sec

** In case of thermal-thermal system, the two thermal areas are assumed to have the same parameters (unless specified otherwise).

REFERENCES

- [1] D.M.V. Kumar, "Intelligent controllers for automatic generation control," *Proceedings of IEEE TENCEN'98, Energy, Computer, Communication control*, vol. 2, 1998, pp. 557-574.
- [2] Y. L. Abdel-Magid and M. M. Dawoud, "Tuning of AGC of interconnected reheat thermal systems with genetic algorithms," *IEEE International Conference on Systems, Man and Cybernetics*, Vancouver, BC, vol. 3, 1995, pp. 2622 – 2627.
- [3] J. J. Grefenstette, "Optimization of control parameters for genetics algorithms," *IEEE Trans. Systems, Man and Cybernetics*, SMC-16, no. 1, Feb. 1986.
- [4] K. De Jong, "Adaptive system design: a genetic approach," *IEEE Trans. Systems, Man and Cybernetics*, SMC-10, no. 9, pp. 1566-574, Sept. 1980.
- [5] P. J. Fleming and C. M. Fonseca, "Genetic algorithms in control systems engineering," Research Report No. 470, *Dept. of Automatic control and Systems Engineering, University of Sheffield*, Sheffield, U.K., March 1993.
- [6] R. C. Eberhart and Y. Shi, "Particle swarm optimization: developments, applications and resources," *Proceedings of the IEEE Congress on Evolutionary Computation (CEC 2001)*, Seoul, Korea, 2001, pp. 81-86.
- [7] R. Eberhart and J. Kennedy, "Particle swarm optimization," *Proceedings of the IEEE International Conference on Neural Networks*, Perth, Australia, December 1995.
- [8] Y. L. Abdel-Magid and M. A. Abido, "AGC tuning of interconnected reheat thermal systems with particle swarm optimization," *Proc. 10th IEEE International Conference on Electronics, Circuits and Systems, ICECS*, vol. 1, 2003, pp. 376- 379.
- [9] S. P. Ghoshal, "Application of GA/GA-SA based fuzzy automatic generation control of a multi-area thermal generating system," *Electric Power Systems Research*, vol. 70, no. 2, pp. 115-127, July 2004.
- [10] G. A. Chown, R. C. Hartman, "Design & experience of fuzzy logic controller for automatic generation control (AGC)," *IEEE Trans. on Power Systems*, vol. 13, no. 3, pp. 965-970, Aug. 1998.
- [11] A.A.A. Osim and A.R. Aoki, "Particle swarm optimization for fuzzy membership functions optimization," *Proc. 2002 IEEE International Conference on Systems, Man and Cybernetics*, vol. 3, Oct. 2002, pp. 6-10.
- [12] Y.L. Karnavas and D.P. Papadopoulos, "AGC for autonomous power system using combined intelligent techniques," *Electric Power Systems Research*, vol. 62, no. 3, pp. 225-39, July 2002.
- [13] R. N. Patel, "Application of artificial intelligence for tuning the parameters of an AGC," *International Journal of Mathematical, Physical and Engineering Sciences*, World Academy of Science, Engineering and Technology (WASET), vol. 1, no. 1, pp. 34-39, 2008.
- [14] Earl Cox, *Fuzzy Fundamentals*. IEEE Spectrum, Oct 1992, pp. 58-61.
- [15] SimPowerSystems User guide. Available: <http://www.mathworks.com>

R.N. Patel did his B.E. in Electrical Engineering in year 1997. He acquired his M. Tech. and Ph. D. (Power Systems) degrees from IIT Delhi in years 1998 and 2002 respectively. He has worked as a faculty of Electrical Engineering in IIT Roorkee during year 2003-2006. Presently he is working as a faculty in the Electrical Engineering department at SSCET, Bhilai, India. His main fields of interest are: Power System dynamics and Stability, Modelling of Power Systems and AI applications to Power Systems. Dr. Patel has more than 45 publications in various International Journals and Conferences.

S. K. Sinha is Assistant Professor in the Department of Electrical Engineering at College of Engineering Roorkee, India. He received his B.Tech degree in the year 1990 from MIT Muzaffarpur and M.Tech degree in 1994 from Regional Institute of Technology, Jamshedpur, India. He is currently a PhD candidate at IIT Roorkee. His field of interest comprises Power System Analysis, Power System Restructuring and applications of Artificial Intelligence Techniques in the area of power system.

R. Prasad is Associate Professor in the Department of Electrical Engineering at IIT Roorkee. He received his BE, ME and PhD degrees from University of Roorkee, India in the years 1977, 1979 and 1990 respectively. His areas of interest are Control Optimization System Engineering and Model Reduction of Large Scale Systems. He has guided 4 Ph D scholars and has published 110 research papers in international and national journals and conferences. Prof. Prasad has bagged several best paper awards.