

Design Considerations of PV Water Pumping and Rural Electricity System (2011) in Lower Myanmar

Nang Saw Yuzana Kyaing, Wunna Swe

Abstract—Photovoltaic (PV) systems provides a viable means of power generation for applications like powering residential appliances, electrification of villages in rural areas, refrigeration and water pumping. Photovoltaic-power generation is reliable. The operation and maintenance costs are very low. Since Myanmar is a land of plentiful sunshine, especially in central and southern regions of the country, the solar energy could hopefully become the final solution to its energy supply problem in rural area.

Keywords—Myanmar, Standalone PV Inverter, PV Water Pumping, Design Analysis, Induction Motor Driving System

I. INTRODUCTION

THE geographical location of Myanmar is between latitude $9^{\circ} 58' N$ and $28^{\circ} 29' N$ and longitude $92^{\circ} 10' E$ and $101^{\circ} 10' E$. The climate is monsoonal, with three distinct seasons: a rainy season from June to October, a cooler and drier "winter" from November to February, and a hot dry season from March to May. Sunshine is plentiful during the dry season, averaging 7 to 10 hours a day. During the rainy season the weather is cloudier and daily sunshine amounts average only 3 to 4 hours a day. The radiated heat energy from the sun on to the earth converted to horse power is 469×10^{11} [3]. Therefore, total approximate horse power on total area of Myanmar is calculated to be 123×10^{10} , that is the sun's radiated heat power.

For the poor, the priority is the satisfaction of such basic human needs as jobs, food, health services, education, housing, clean water and sanitation. Energy plays an important role in ensuring delivery of these services. Low energy consumption is not a cause of poverty and energy is not a basic human need. However, lack of energy has been shown to correlate closely with many poverty indicators. At the household level, although not recognised explicitly as being one of the basic needs, energy is clearly necessary for the provision of nutritious food, clean water and a warm place to live. In most rural households, particularly the poorest, the amount of useful energy consumed is less than what is required to provide a minimum standard of living. This has led to 'norms' are being used by planning agencies when evaluating energy demand in rural areas.

Nang Saw Yuzana Kyaing is with the department of Electrical Power Engineering, Mandalay Technological University (MTU), Mandalay, Myanmar (corresponding first author to provide phone: +95-09-5230182; fax: +95-02-57361; e-mail: nansawuzana@gmail.com).

Wunna Swe is now with the Department of Electrical Power Engineering, Mandalay Technological University (MTU), Mandalay, Myanmar (e-mail: khwunn@gmail.com).

II. STANDALONE PV INVERTER AND PV WATER PUMPING

A. Standalone PV Inverter

The basic components of a stand-alone PV inverter system are PV array, charge controller, battery, inverter and AC load. Each component has its own types or topologies and control methods. Fig.1 views the basic component of a stand-alone PV inverter.

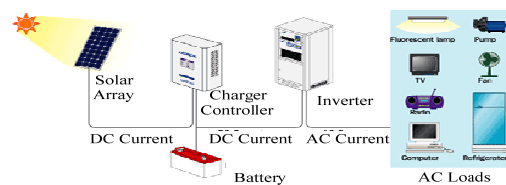

Fig. 1 The Basic Components of a Stand-alone PV Inverter

B. PV Water Pumping System

Two different systems configurations are currently been studied:

System 1: PV array is directly coupled to a DC motor and a pump.

System 2: PV array coupled to an inverter which is then coupled to AC motor and a pump

The directly couple systems, where the PV array is directly coupled to a DC motor-pump system, is shown in Fig. 2. The PV array coupled to an inverter, which is then coupled to a single-phase AC motor, and a pump system is shown in Fig. 3.

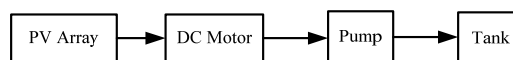

Fig. 2 DC Motor Driven System

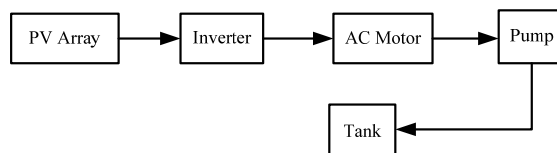

Fig. 3 AC Motor Driven System

When using an AC motor, the solar photovoltaic array needs to be connected to an inverter that is then connected to the AC motor. The inverter converts the DC voltage coming

from the solar panel into AC voltage, which drives the induction motor. These systems have revolutionised, where many people in remote areas with no access to clean water, could now have access to clean drinking water [5]. The ability of providing pasteurised water has freed labourers, mainly women and children from the time consuming task of carrying water from distant springs. With the availability of groundwater and sunlight, solar photovoltaic powered water pumping are more cost effective in remote areas and for small applications. It has also been discovered that using an AC motor pump combined with a variable-speed DC-AC inverter is optimised by working at low speeds and full on during hours of daylight as well as during hours of low irradiation. The AC motor can however be expensive, as it requires an inverter, which lowers the overall system efficiency rate. Though, when a better output performance is required during low levels of irradiation, the AC motor exceeds its performance capabilities compared to the DC motor. The DC motor stops completely during cloud cover or environmental pollution. Given the continuously changing solar irradiance levels, the most practical solution is choosing a motor that is highly efficient in providing the maximum amount of water during solar water pumping, specifically during times when solar irradiance is low [4].

III. DESIGN ANALYSIS

A. Hydraulic Energy Requirements

Once the gross water requirements are known, the hydraulic requirements can be determined [1], using the equation:

Hydraulic energy = $9.81 \times \text{volume (m}^3 \text{ per day)} \times \text{total head (m)} / 1000$

A who survey in 1970 showed that the average water consumption in developing countries ranges from 35 to 90 litres per capita per day [2]. The long term aim of water development is to provide all people with ready access to safe water in the quantity they want. However, in the short term a reasonable goal to aim for would be a water consumption of about 90 litres per capita per day. Thus for typical village populations of 500, water supplies will have to be sized to provide about 45 m^3 per day.

For consider head of 30.48 m (100 feet): pipe head loss is 10% of the total static head = 3.048 m.

$$\begin{aligned} \text{So, Hydraulic energy} &= 9.81 \times 45 \times (30.48 + 3.048) / 1000 \\ &= 14.8 \text{ MJ} = 14.8 / 3.6 \text{ kWh} \\ &= 4.11 \text{ kWh} \end{aligned}$$

If pump operating time is 6 hours/day,

The flow rate (Q) = $45 \times 1000 / (6 \times 3600) = 2.08 \text{ litres/sec}$

Then the hydraulic power is:

$$\begin{aligned} P &= 9.81 \text{ Qh Watts} \\ &= 9.81 \times 2.08 \times 30.48 = 621.94 \text{ W} \end{aligned}$$

B. Design of Pump Motor

The pump is driven by AC induction motor whose optimal value can be computed by the following expression:

$$\text{Motor Power} = \frac{P}{\eta}$$

Where P = Hydraulic power of pump [W],

η = Efficiency of pump

With a typical pump efficiency of 60%, the mechanical power required would be: $621.94 / 0.6 = 1036.6 \text{ Watts}$

So, Pump motor size must be at least 1036.6W and choose 1½ hp (1120W) AC single-phase capacitor start/ run induction motor. And the pump type is chosen compressor pump type.

C. Size the PV Modules

Different size of PV modules will produce different amount of power. To find out the sizing of PV module, the total peak watt produced needs. The peak watt (Wp) produced depends on size of the PV module and climate of site location. We have to consider "panel generation factor" which is different in each site location. For Myanmar, the panel generation factor is 3.43. To determine the sizing of PV modules, calculate as follows:

A village has the following electrical appliance to use:

At day time, one 1120 Watt water pump motor with compressor that runs 6 hours per day.

At night time, one 20 Watt fluorescent lamp with electronic ballast used 4 hours per day for 70 home.

Multiply the total appliances Watt-hours per day times 1.3 (the energy lost in the system) to get the total Watt-hours per day which must be provided by the panels.

Total appliance use	= (20 W x 4 hours) x 70
	+ 1120 x 6
	= 10.92 kWh/day
Total PV panels energy needed	= 10920 x 1.3
	= 14.196 kWh/day.
Total Wp of PV panel capacity needed	= 14196 / 4.63
	= 3066.09 Wp
Number of PV panels needed	= 3066.09 / 155
	= 19.78 modules

Actual requirement = 20 modules

So, this PV water pumping and rural electricity system should be powered by at least 20 modules of 155 Wp PV module.

D. Inverter Sizing

Total Watt of all appliances = 2520 W. For safety, the inverter should be considered 25-30% bigger size.

The inverter size should be about 3.5 kW or greater.

In this project, Leconics Apollo S-210 series bidirectional inverter 3.5 kW is chosen [7]. The input of this inverter is 48 Vdc and the output is 220 Vac ± 1%.

E. Battery Sizing

The pumping AC induction motor is directly supplied by the PV generator through charge controller and inverter.

So, Total appliances use = 10.92 kWh/day
 Nominal battery voltage = 12 V
 Days of autonomy = 1.3 days
 Battery losses = 0.85
 Depth of discharge = 0.6

$$\text{Battery (Ah)} = \frac{\text{Watt-hours per day} \times \text{Days of autonomy}}{(0.85 \times 0.6 \times \text{nominal battery voltage})}$$

$$= \frac{10920 \times 1.3}{(0.85 \times 0.6 \times 12)} = 2319 \text{ Ah}$$

Total Ampere-hours required 2319 Ah.

So the battery should be rated 12 V ,120Ah x20 = 2400 Ah for 1.3 day autonomy.

F. Solar charge controller sizing

SunWize® SW155 Solar Module PV specification

$P_m = 155 \text{ Wp}$
 $V_m = 33.4 \text{ Vdc}$; $I_m = 4.65 \text{ A}$
 $V_{oc} = 42 \text{ V}$; $I_{sc} = 5.28$

Solar charge controller rating = $(20/2 \text{ strings} \times 4.65 \text{ A}) \times 1.3 = 60 \text{ A}$

So the solar charge controller should be rated 60 A at 48 V or greater. But, the inverter input is 48 Vdc, therefore 30A and 30A Solarcon solar charge controller with timer are chosen. And in this PV water pumping and rural electricity system, each 2 modules are series connected to obtain 48 Vdc and each 4 deep cycle 12 V 120Ah battery are also connected in series.

IV. LOCATION AND PROJECT OF PV WATER PUMPING SYSTEM

PV water pumping system is providing safe water supply for communities affected by cyclone Nargis project for Myittha village. Myittha village was situated in Kumchangan Township of Yangon Division. According to the radiation records, the monthly average radiation is high at Kumchangan Township within lower Myanmar.

The project photos are shown in following Figures.

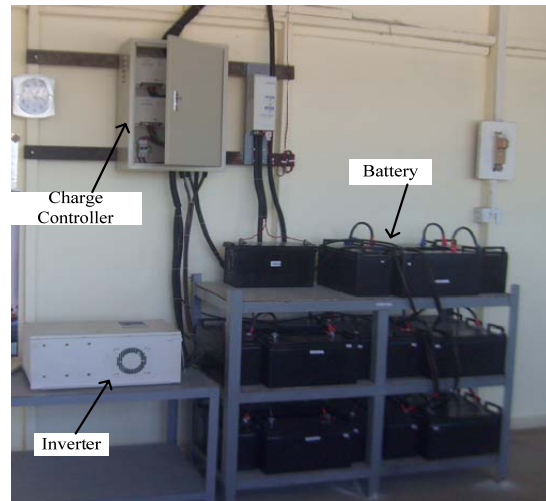

Fig. 4 Energy Storage Batteries and Control Room



Fig. 5 PV Panel Installation on the roof of Building

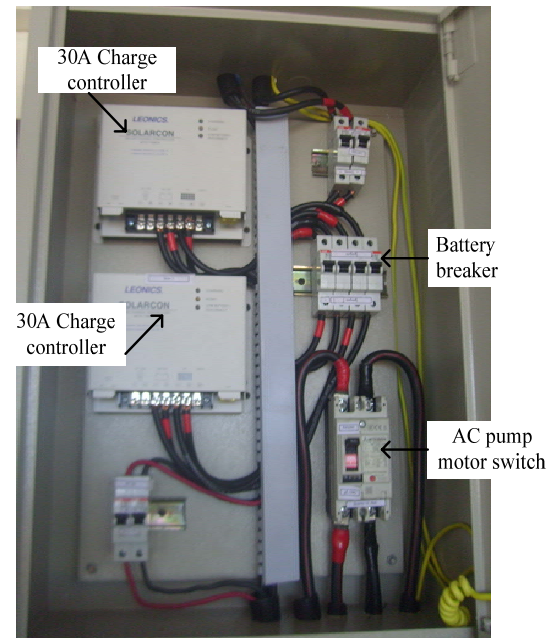

Fig.6. Charge Controller and Switch Box

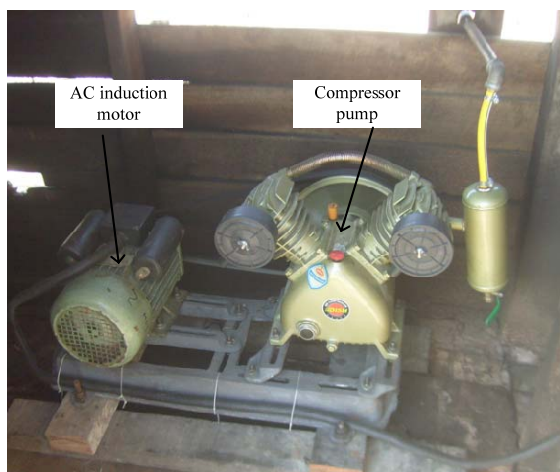

Fig. 7 Compressor Pump and AC Motor

V. TEST SIMULATION AND RESULTS

The single-phase induction motor is rated at 220 V. Varying the frequency applied to the motor controls the speed. Application of this speed control method also required the variable frequency drive.[6] If the voltage drop is small compared to the terminal voltage, then the motor flux is directly proportional to the voltage/frequency ratio. The terminal voltage is thus varied in proportion to the frequency. This type of control is known as constant volts per hertz.

The induction motor system was then set-up as shown in the Fig. 8 below and tested to see the variation in water flow rate and input power consumption with change in voltage and frequency.

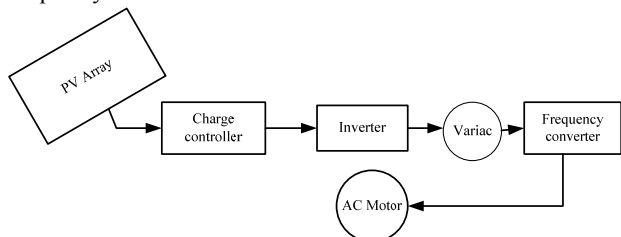

Fig. 8 Experimental Setup for Single-phase Induction Motor Drive

Table I below shows values of voltage by autotransformer and the frequency varied by frequency converter. Input power to the pump was calculated as well as the flow rate in litres/second.

TABLE I

INDUCTION MOTOR TEST SHOWING VALUES OF VARYING VOLTAGE WITH VARYING FREQUENCY

V _{in} (V)	Current (A)	f (Hz)	Flow rate (Litres/sec)	P _{in} (W)
10	1	1	0.05	9
20	2.0	4	0.15	37
40	2.4	5	0.33	82
60	2.9	10	0.45	155
80	3.1	15	0.6	223
100	3.5	20	0.75	388
120	3.8	25	0.8	475
140	4	30	1.1	504
160	4.1	35	1.3	590

180	4.3	40	1.5	660
200	5	45	1.8	850
220	5.5	50	2	1100

Fig. 9 below shows the relationship between varying input voltages (V) and flow rate (litres/s) and input power. As discussed before, varying the frequency f can control the speed of the motor or the flow rate of water, keeping the flux in the air gap constant and varying V_{in} in a linear proportion to f.

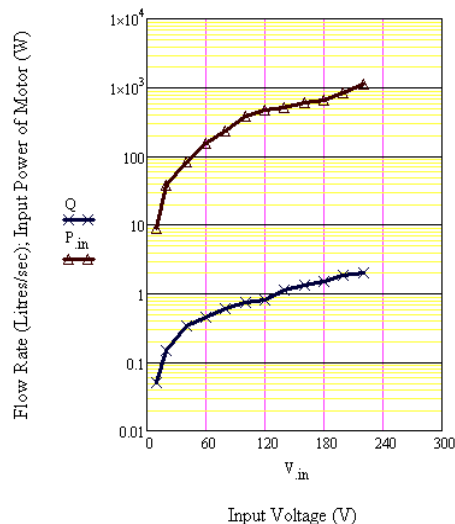

Fig. 9 Flow Rate- Input Power as Voltage Varying in Induction Motor

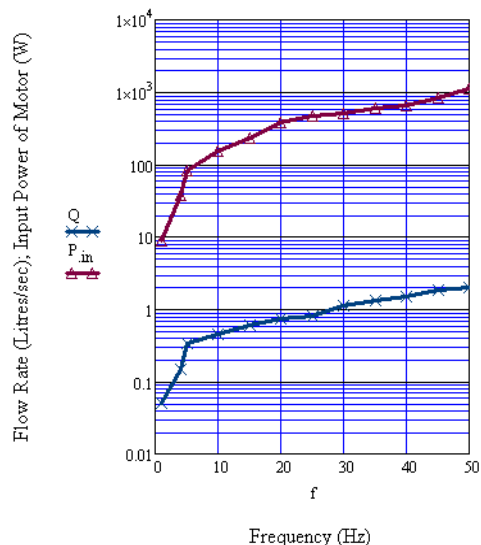

Fig. 10 Flow Rate- Input Power as Frequency Varying in Induction Motor

VI. CONCLUSIONS

This paper investigates the design considerations of a photovoltaic powered AC motor drive for water pumping application and rural electricity. A number of experimental PV

powered DC motor drives for water pumping are already in use, however such schemes find limited applications due to high cost and maintenance problems commonly associated with DC commutator type machines. Here an attempt is made to use a single phase induction motor which apparently is more robust, less expensive and requires little or no maintenance. This project can be used to relate input quantities like solar array voltage, current to outputs like speed, torque. The design consideration of the pumping and electricity system is presented and the results can be used to select the ratings of the various components. In photovoltaic pump systems, the solar array accounts for a substantial fraction of the overall system cost. Therefore, all system components must have a high efficiency in a large power range. Low voltage standard induction motors do not fit this criterion. So, it is need to change more efficient motor, pump type and lighting system for more loading and improvement of the whole system.

ACKNOWLEDGMENT

The author would like to express grateful thanks to her supervisor Dr. Wunna Swe, Associate Professor and Head, Department of Electrical Power Engineering, and to all her teachers from Mandalay Technological University. The author's special thanks are sent to her parents, U Ohn Kyaing and Daw Nang Saw Khin, for their guidance from childhood till now.

REFERENCES

- [1] Kenna, Jeff. and Gillett Bill. "*Handbook of Solar water pumping*", Sir William Halcrow and Partner and Intermediate Technology Ltd. 1985
- [2] Soteris Kalogirou "*Solar Energy Engineering: Processes and System*", Elsevier Inc. 2009.
- [3] S.R. Wenham M.A. Green M.E. Watt R. Corkish "*Applied Photovoltaics*" Second Edition, ARC Centre for Advanced Silicon Photovoltaics and Photonics. 2007.
- [4] A.A. Ghoneim, "*Design optimization of photovoltaic powered water pumping systems*". Energy Conversion and Management 47 (2006)
- [5] J.L. Davies, "*The Design and Optimization of a System using an Induction Motor driven pump, powered by solar panels*", 30 April 1992
- [6] P.C SEN, "*Principles of Electric Machines and Power Electronics*", second edition, 1997, (Pages 197,227-228)
- [7] <http://www.leconics.com>