

# Design and Simulation of Low Noise Amplifier Circuit for 5 GHz to 6 GHz

Hossein Sahoolizadeh, Alishir Moradi Kordalivand, and Zargham Heidari

**Abstract**—In first stage of each microwave receiver there is Low Noise Amplifier (LNA) circuit, and this stage has important rule in quality factor of the receiver. The design of a LNA in Radio Frequency (RF) circuit requires the trade-off many importance characteristics such as gain, Noise Figure (NF), stability, power consumption and complexity. This situation Forces desingers to make choices in the desing of RF circuits. In this paper the aim is to design and simulate a single stage LNA circuit with high gain and low noise using MESFET for frequency range of 5 GHz to 6 GHz. The desing simulation process is down using Advance Design System (ADS). A single stage LNA has successfully designed with 15.83 dB forward gain and 1.26 dB noise figure in frequency of 5.3 GHz. Also the designed LNA should be working stably In a frequency range of 5 GHz to 6 GHz.

**Keywords**—Advance Design System, Low Noise Amplifier, Radio Frequency, Noise Figure.

## I. INTRODUCTION

DESIGNING amplifiers for a minimum noise figure then becomes simply a matter of setting the optimum condition for a particular transistor. Based on S parameters of the transistor and certain performance requirements, a systematic procedure is developed for the design of the LNA. In LNA design, the most important factors are low noise, moderate gain, matching and stability. In the designed LNA of this paper, forward gain and noise figure is obtained, and compared with ref [8].

## II. EQUIVALENT CIRCUIT OF MICROWAVE MESFET

Most microwave amplifiers today use Gallium Arsenide (Ga As) Field-Effect Transistor (FETs). They can presently be used at frequencies up to 100 GHz in a wide variety of applications requiring low noise figure, broad band width and medium power capacity [1] [2]. Knowledge of the equivalent circuit of a MESFET is very useful for the device performance analysis (gain, noise, etc...) in designing of microwave circuits. In this paper low noise GaAs MESFET NE 76000 has

been used for the design of LNA. The NE 76000 provides a low noise figure and high associated gain though K-Band. Fig. 1 show the equivalent circuit of this transistor which has been recovered by NEC Company for frequency range of 1 GHz to 26 GHz [3].

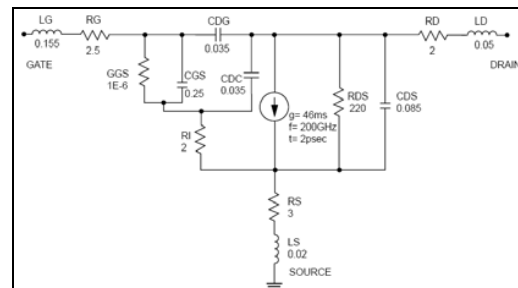

Fig. 1 Equivalent Circuit of NE 76000 Transistor

## III. DC BIASING

In order to design a low noise device, the transistor must be DC biased at an appropriate operating point. These depends of the application (low noise, high gain, high power), and the type of the transistor (FET, HEMT, etc) [4].

Accounts both source and load mismatch. Thus from [6], can be define separate effective gain factors for the input (Source) matching network, the transistor itself and the output (load) matching network as follow .

$V_d$  (drain voltage) = 3V and  $I_{ds}$  (drain-Source current) = 10 mA. This biasing point is obtained by using a  $V_g$  (Gate Voltage) range from -0.6 V to -0.3 V as shown in I-V curves in Fig. 3 [5].

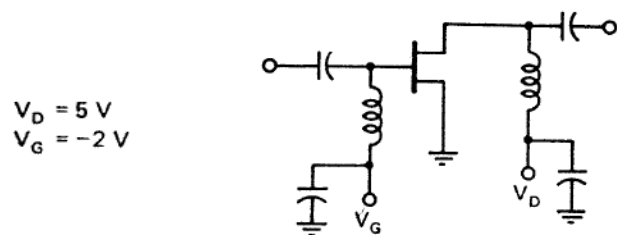

Fig. 2 Basic DC biasing network

F. Hossein Sahoolizadeh is with Young Researchers club of Arak Islamic Azad University, Arak branch, Iran (e-mail: hosein\_sahooli@yahoo.com).

S. Alishir Moradi Kordalivand is with Young Researchers club of Arak Islamic Azad University, Arak branch, Iran (e-mail: ali24412000@yahoo.com).

T. Zargham Heidari is with the Electrical Engineering Department, Islamic Azad University of Iran, Khormoj branch, Boushehr, Iran (e-mail: nariman\_azma@yahoo.com).

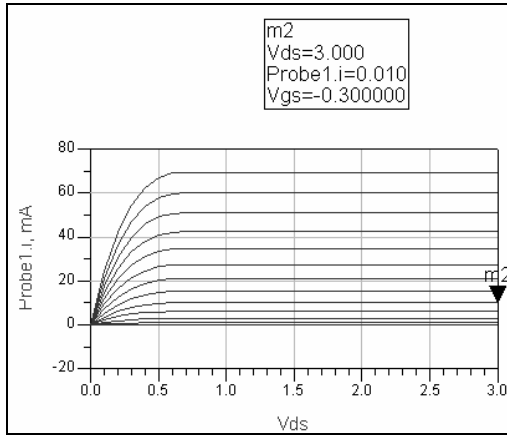

Fig. 3 Appropriate Operating Point of bias DC

A. Single Stage Amplifier

A single stage microwave transistor amplifier can be modeled by the circuit in Fig. 4, where a matching network is used both sides of the transistor to transform the input and output impedance  $Z_0$  to the source and load impedance  $Z_s$  and  $Z_L$ . The most useful gain definition for amplifier design is the transducer power gain, which accounts both source and load mismatch. Thus from [6], can be define separate effective gain factors for the input (Source) matching network, the transistor itself and the output (load) matching network as follow:

$$G'_s = \frac{1 - |\Gamma_s|^2}{|1 - \Gamma_{IN} \Gamma_s|^2} \tag{1}$$

$$G_o = |S_{21}|^2 \tag{2}$$

$$G_L = \frac{1 - |\Gamma_L|^2}{|1 - S_{22} \Gamma_L|^2} \tag{3}$$

Then the overall transducer gain is  $GT = G_s' G_o G_L$ . The effective gains from  $G_s$  and  $G_L$  are due to the impedance matching of the transistor to the impedance  $Z_0$ .

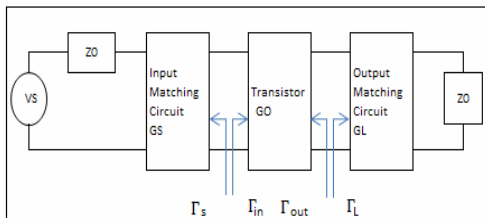

Fig. 4 The General Transistor Amplifier Circuit

B. Stability Consideration

The stability of an amplifier, or its resistance to oscillate, is a very important consideration in a design and can be determined from the S parameters, the matching networks, and the terminations. In th circuit Fig. 5, oscillations are possible when either the input or output port presents a negative resistance. This occurs when  $|\Gamma_{in}| > 1$  or  $|\Gamma_{out}| > 1$ . These because of  $\Gamma_{in}$  and  $\Gamma_{out}$  depend on the source and load matching networks. While, the stability of the amplifier depends on  $\Gamma_S$  and  $\Gamma_L$  as presented by the matching networks. Alternatively, it can be shown that the amplifier will be unconditionally stable if the following necessary and sufficient conditions are met [7]:

$$K = \frac{1 - |S_{11}|^2 - |S_{22}|^2 + |\Delta_s|^2}{2|S_{21} S_{12}|} > 1 \tag{4}$$

And

$$|\Delta| < 1 \tag{5}$$

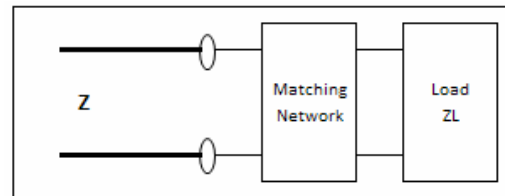

Fig. 5 A lossless network matching networks arbitrary load impedance to a transmission line

In this paper, for the stability of the circuit a RLC feedback has been established between the drain-gate. Fig. 6 shows this feedback. Also for accurate adjustment of stability, sufficient noise and gain, a new idea presented that's mean by adding two RLC circuit between the gate-earth and drain-earth in LNA circuit as it shown in Fig. 7.

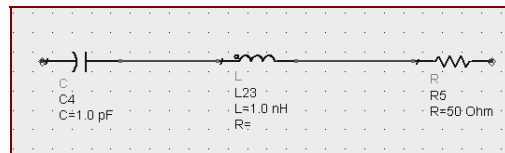

Fig. 6 Feedback circuit for stability increment

IV. MATCHING NETWORK

The basic idea of the impedance matching is illustrate in Fig. 5, which shows an impedance matching network placed between load impedance and transmission line. The need for matching network arises because amplifiers, in order to deliver maximum power to a load, or to perform in a certain desired way, must be properly terminated at both the input and output ports. The matching network is ideally lossless to avoid

unnecessary loss power and is usually designed so that looking into the matching network is  $Z_0$ . Several types of matching network are available, however factors like complexity, bandwidth, implementation and adjustability need to be considered in the matching network selection.

The impedance matching networks can be designed either mathematically or graphically with the aid of Smith chart. The matching network is chosen in this design as shown in Fig. 7.

V. NOISE FIGURE SIMULATION RESULT

The lowest noise figure is needed in order to achieve the maximum gain. Fig. 8 shows the minimum noise figure plot. The lowest  $F_{min}$  1.261 dB obtained at frequency 5.3 GHz. The minimum noise figure 1.265 dB is obtained at frequency 5 GHz, while minimum noise figure 1.295 dB is reads at frequency 6 GHz. The  $F_{min}$  value is rising slowly as frequency increases.

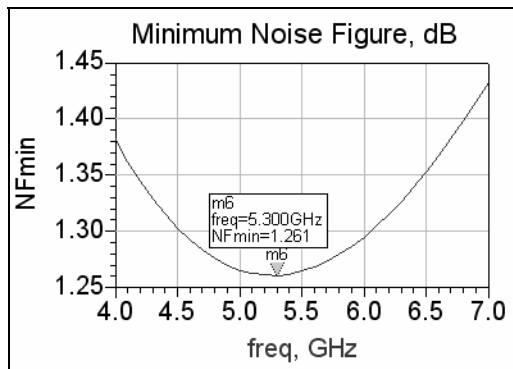

Fig. 8 Minimum Noise figure

VI. EXPERIMENTAL RESULT

The designed LNA with matching network at 5.3 GHz was obtained. The forward gain ( $S_{21}$ ), isolation ( $S_{12}$ ),  $S_{11}$  and  $S_{22}$  plot is shown in Fig. 9. The result shows that the  $|S_{11}| < 1$  and  $|S_{22}| < 1$  fulfills the stability condition. The highest forward gain ( $S_{21}$ ) is 15.832 dB at 5.3 GHz as showed in Fig. 10. The designed LNA also shows a good isolation when  $S_{12}$  value is below -23 dB at 5 GHz to 6 GHz frequency band.

Also the stability factor, K Plot is shown in Fig. 11. Thus, the design LNA should be working stably in frequency range of 5 GHz to 6 GHz. Figure the best impedance matching for high gain and low noise in frequency range of 5 GHz to 6 GHz. Table I compares result of the designed LNA with the designed circuit in Ref [8].

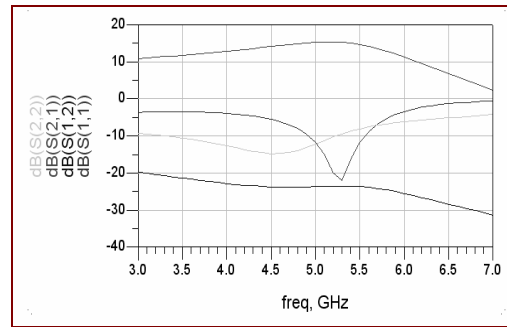

Fig. 9 S-Parameter Plot

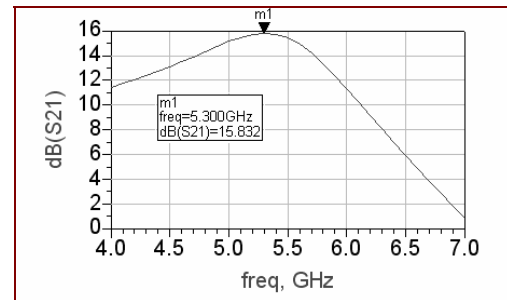

Fig. 10  $S_{21}$ (dB) – Plot

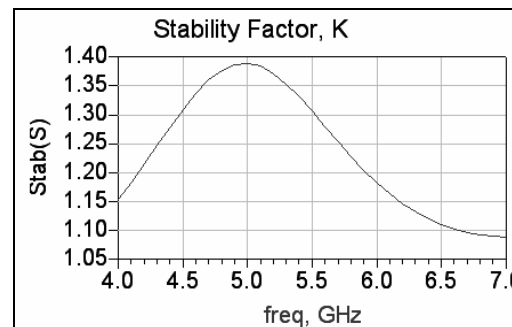

Fig. 11 Stability Factor (K) Plot

TABLE I

5-6GHZ	The designed LNA	Ref. [8]
Nfmin	<b>1.26 dB</b>	1.509 dB
dB(S21)	<b>15.832dB</b>	7.78dB
dB(S12)	<b>-22.23dB</b>	-14.403dB
dB(S11)	<b>-22.4dB</b>	-22dB
dB(S22)	<b>-15.3dB</b>	-32dB

VII. CONCLUSION

In this paper, a new Low Noise Amplifier (LNA) circuit design for frequency of 5 GHz to 6 GHz presented and circuit simulation were done in ADS. LNA has successfully developed with 15.83 dB gain and 1.26 dB noise figure at frequency 5 GHz to 6 GHz.

REFERENCES

- [1] C.A. Balanis, Antenna Theory: Analysis and design, Harper and Row, N.Y., 1982.
- [2] K. Miyauchi, "Millimeter-Wave Communication," in Infrared and millimeter waves, Vol.9, K.J.Button, ED., Academic pres, N.Y., 1983.
- [3] Exclusive North America Agent for NEC RF, Microwave & optoelectronic semi conductors CEL California Eastern Laboratories-Headquarters-4590 patrick henry drive, santa clara, CA 95054-1817-www.CEL.com
- [4] Microwave Engineering-David M-Pozar. John Wiley & Sons. INC-New York. Chichester. Weinheim. Brisbane-Singapore. Toronto.
- [5] Agilent Technologies (2000)."Application Noto 1190-Low Noise Amplifier for 900 MHz using the Agilent ATF-34143 Low Noise PHEMT". USA: Agilent Technologies. 1-8.
- [6] D.M. Pozar (2000). "Microwave RF Wireless System",United State of America: John Wiley and Sons Inc. 77797, 205-207.
- [7] Microwave Transistor Amplifier Analysis and Design. Guillermo Gonzalez, Ph.D. 1984 by Prentice-Hall, Inc., Englewood Cliffs, New Jersey 07632.
- [8] Mohd. Zinol Abidin Abd Aziz(2004). "Low Noise Amplifier Circuit Design for 5 GHz to 6 GHz", Proceeding of the 2004 IEEE – 0-7803-8671-X/04-/RF and Microwave conference, October 5-6, Subang, Selangor, Malaysia. 81300 Skudai, Johor, Malaysia will be deleted from the biography.

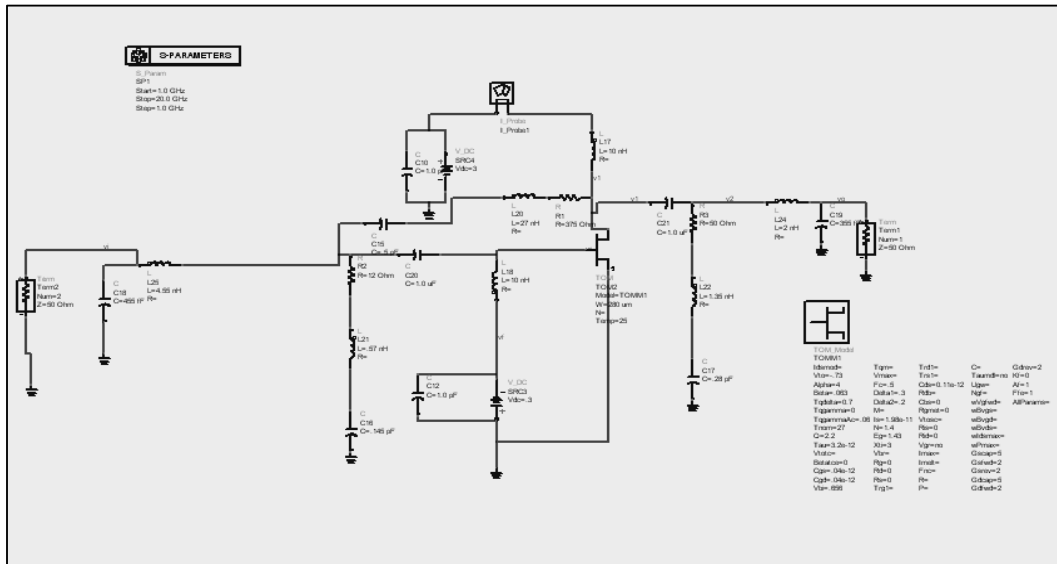

Fig. 7 The LNA Designed with input and output matching network