

Damping Power System Oscillations Improvement by FACTS Devices: A Comparison between SSSC and STATCOM

J. Barati, A. Saeedian, and S. S. Mortazavi

Abstract—The main objective of this paper is a comparative investigate in enhancement of damping power system oscillation via coordinated design of the power system stabilizer (PSS) and static synchronous series compensator (SSSC) and static synchronous compensator (STATCOM). The design problem of FACTS-based stabilizers is formulated as a GA based optimization problem. In this paper eigenvalue analysis method is used on small signal stability of single machine infinite bus (SMIB) system installed with SSSC and STATCOM. The generator is equipped with a PSS. The proposed stabilizers are tested on a weakly connected power system with different disturbances and loading conditions. This aim is to enhance both rotor angle and power system stability. The eigenvalue analysis and non-linear simulation results are presented to show the effects of these FACTS-based stabilizers and reveal that SSSC exhibits the best effectiveness on damping power system oscillation.

Keywords—Power system stability, PSS, SSSC, STATCOM, Coordination, Optimization, Damping Oscillations.

I. INTRODUCTION

ELECTROMECHANICAL oscillations have been observed in many power systems [1],[2],[3]. The oscillations may be local to a single generator or generator plant (local oscillations), or they may involve a number of generators widely separated geographically (inter-area oscillations). Electromechanical oscillations are generally studied by modal analysis of a linearized system model [2],[4]. The most common control action to enhance damping of power system oscillations is the use of power system stabilizers (PSS_s). Although PSSs provide supplementary feedback stabilizing signals, they suffer a drawback of being liable to cause great variation in the voltage profile. Recently, several FACTS devices have been implemented and installed in practical power systems such as static VAR compensator (SVC), thyristor controlled series capacitor (TCSC), and thyristor controlled phase shifter (TCPS) [5-7]. The

emergence of FACTS devices and in particular gate turn-off (GTO) thyristor-based STATCOM has enabled such technology to be proposed as serious competitive alternatives to conventional SVC. Nowadays, series power electronics-based controllers FACTS such as Static Synchronous Series Compensator (SSSC), have become one of the best alternatives means to damp power system oscillation [8]-[10]. From the power system dynamic stability viewpoint, the STATCOM provides better damping characteristics than the SVC as it is able to transiently exchange active power with the system [11]. A multivariable design of STATCOM AC and DC voltage control is presented in [12]. The coordination between the AC and DC voltage PI controllers was taken into consideration. However, the structural complexity of the presented multivariable PI controllers with different channels reduces their applicability. Moreover, the utilization of damping capability of the STATCOM has not been addressed. The STATCOM damping characteristics have been addressed in [13-20]. However, the coordination among the STATCOM damping controllers and AC and DC voltage PI controllers has not been investigated. In this study, a comprehensive assessment of the effectiveness of the PSS and STATCOM damping stabilizers when applied in coordination with the STATCOM internal AC and DC voltage controllers has been carried out. The benefits of using an SSSC are listed in [21]-[23]. This paper presents a comparative study of the effects of PSS and FACTS-based controllers, namely, Static Synchronous Series Compensator (SSSC), and static synchronous compensator (STATCOM) on power system electromechanical oscillations damping. The controller design problem is formulated as an optimization problem. A Genetic algorithm (GA) is employed to search the optimal settings of stabilizer parameters. Moreover, the potential of the proposed PSS and FACTS-based has been demonstrated to enhance the power system small disturbance stability.

J. Barati is Ms Student at Shahid Chamran University, Ahvaz, Iran (e-mail: tj_barati62@yahoo.com).

A. Saeedian, assistant professor, is with the Electrical Engineering Department, Shahid Chamran University, Ahvaz, Iran (e-mail: a_saeedian2000@yahoo.com).

S.S. Mortazavi, assistant professor, is with the Electrical Engineering Department Shahid Chamran University, Ahvaz, Iran (e-mail: mortazavi_s@scu.ac.ir).

II. POWER SYSTEM MODEL

A. Generator

In this study, a single machine infinite bus (SMIB) power system installed with SSSC and STATCOM are investigated, as shown in Fig. 1. The generator is equipped with a PSS. The generator has a local load of admittance $Y_L = g + jb$ and the transmission line has impedances of $Z=R + jX$ for the first and the second sections respectively. The generator is represented by the third-order model comprising of the electromechanical swing equation and the generator internal voltage equation. The swing equation is divided into the following equations

$$\dot{\delta} = \omega_b (\omega - 1) \tag{1}$$

$$\dot{\omega} = (P_m - P_e - D (\omega - 1)) / M \tag{2}$$

where, P_m and P_e are the input and output powers of the generator; M and D are the inertia constant and damping coefficient; δ and ω are the rotor angle and speed respectively; ω_b is the based speed. The output power of the generator can be expressed in terms of the d -axis and q -axis components of the armature current, i , and terminal voltage, v , as:

$$P_e = v_d i_d + v_q i_q \tag{3}$$

The internal voltage, E'_q , equation is

$$\dot{E}_q = (E_{fd} - (x_d - x'_d) i_d - E_q) / T'_{do} \tag{4}$$

Here, E_{fd} is the field voltage; T'_{do} is the open circuit field time constant; x_d and x'_d are the d -axis reactance and the d -axis transient reactance of the generator respectively.

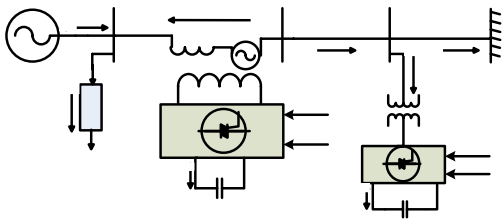

Fig. 1 SMIB with FACTS Devices and PSS

B. Exciter

The IEEE Type-ST1 excitation system shown in Fig. 2 is considered in this work. It can be described as

$$\dot{E}_{fd} = (K_A (V_{ref} - v + u_{pss}) - E_{fd}) / T_A \tag{5}$$

Where, K_A and T_A are the gain and time constant of the excitation system respectively; V_{ref} is the reference voltage. The terminal voltage v can be expressed as:

$$v = (v_d^2 + v_q^2)^{1/2} \tag{6}$$

$$v_d = x_q i_q \tag{7}$$

$$v_q = E'_q - x'_d i_d \tag{8}$$

Where x_q is the q -axis reactance of the generator.

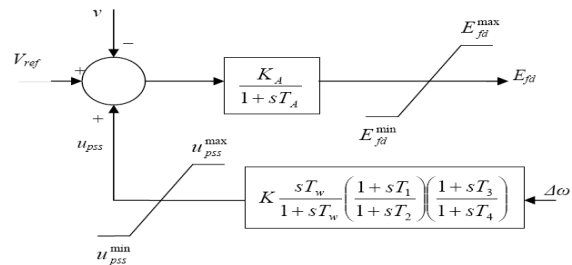

Fig. 2 IEEE Type-ST1 excitation system with PSS

As shown in Fig. 2 a conventional lead-lag PSS is installed in the feedback loop to generate a stabilizing signal u_{pss} .

D. FACTS-Based Stabilizers

As shown in Fig. 1, the SSSC and STATCOM are installed, SSSC consists of a boosting transformer with a leakage reactance of X_{SCT} , and STATCOM at a point in the transmission line through a step-down transformer with a leakage reactance of x_t . The SSSC and STATCOM consists of a three-phase gate turn-off (GTO)-based voltage source converter (VSC) and a DC capacitor. The VSC generates a controllable AC voltage V_o given by

$$V_o = CV_{DC} \angle \psi = CV_{DC} (\cos \psi + j \sin \psi) \tag{9}$$

where $C = mk$, m is the modulation ratio defined by pulse width modulation (PWM), k is the ratio between the AC and DC voltage depending on the converter structure, V_{DC} is the DC voltage, and ψ is the phase defined by PWM. The magnitude and the phase of V_o can be controlled through m and ψ respectively. The DC voltage V_{DC} is governed by

$$\frac{dV_{DC}}{dt} = \frac{I_{DC}}{C_{DC}} = \frac{C}{C_{DC}} (I_{sd} \cos \psi + I_{sq} \sin \psi) \quad (10)$$

where C_{DC} is the DC capacitor value and I_{DC} is the capacitor current while i_{sd} and i_{sq} are the d and q components of the FACTS current i_s respectively. Fig. 3 illustrates the block diagram of FACTS AC/DC voltage PI controller with a damping stabilizer.

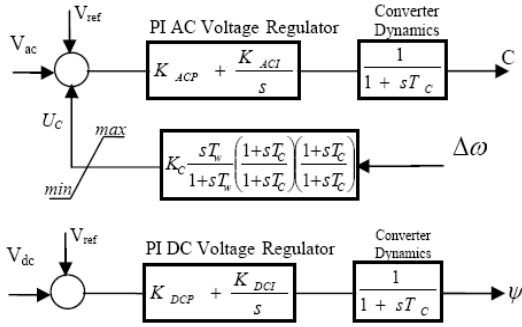

Fig. 3 FACTS AC/DC Voltage Regulator with supplementary damping control in the AC control loop

The proportional and integral gains are K_{ACP} , K_{ACI} and K_{DCP} , K_{DCI} for AC and DC voltages respectively. The FACTS damping stabilizers are lead-lag structure where K_C and K_ψ are the stabilizer gains, T_w is the washout time constant, and T_{1C} , T_{2C} , T_{3C} , T_{4C} , $T_{1\psi}$, $T_{2\psi}$, $T_{3\psi}$, and $T_{4\psi}$ are the stabilizer time constants.

E. Linearized Model SSSC and STATCOM

In the analysis of electromechanical mode damping stabilizers, the linearized incremental model around a nominal operating point is usually employed [24,25]. Linearizing the expressions of i_d and i_q and substituting into the linear form of (1)-(10) yield the following linearized expressions.

$$\Rightarrow \begin{cases} C_7 i_d + C_8 i_q = V_b \sin \delta + C_{11} E'_q + C V_{DC} \cos \psi & (11) \\ C_9 i_d + C_{10} i_q = V_b \cos \delta + C_{12} E'_q + C V_{DC} \sin \psi & (12) \end{cases}$$

Solving (11) and (12) simultaneously, i_d and i_q expressions can be obtained.

$$\begin{cases} C_7 \Delta i_d + C_8 \Delta i_q = V_b \cos \delta \Delta \delta + C_{11} \Delta E'_q + C \cos \psi \Delta V_{DC} \\ \quad + V_{DC} \cos \psi \Delta C - C V_{DC} \sin \psi \Delta \psi & (13) \\ C_9 \Delta i_d + C_{10} \Delta i_q = V_b \sin \delta \Delta \delta + C_{12} \Delta E'_q + C \sin \psi \Delta V_{DC} \\ \quad + V_{DC} \sin \psi \Delta C + C V_{DC} \cos \psi \Delta \psi & (14) \end{cases}$$

Solving (13) and (14) simultaneously, Δi_d and Δi_q can be expressed as:

$$\Delta i_d = C_{19} \Delta \delta + C_{21} \Delta E'_q + C_{23} \Delta V_{DC} + C_{25} \Delta \psi + C_{27} \Delta C \quad (15)$$

$$\Delta i_q = C_{20} \Delta \delta + C_{22} \Delta E'_q + C_{24} \Delta V_{DC} + C_{26} \Delta \psi + C_{28} \Delta C \quad (16)$$

The constants C_7 - C_{28} are expressions of:

$$Z, Y_L, x'_d, x'_q, i_{q0}, i_{d0}, E'_{q0}, C_0, \Psi_0$$

The constants C_1 - C_{24} are expressions of:

$$\Delta v_d = x_q \Delta i_q \quad (17)$$

$$\Delta v_q = \Delta E'_q - x'_d \Delta i_d \quad (18)$$

Using Equations (Δi_d) and (Δi_q), the following expressions can be easily obtained

$$\Delta P_e = K_1 \Delta \delta + K_2 \Delta E'_q + K_{pDC} \Delta V_{DC} + K_{pC} \Delta C + K_{p\psi} \Delta \psi \quad (19)$$

$$(K_3 + sT'_{do}) \Delta E'_q = \Delta E_{fd} - K_4 \Delta \delta - K_{qDC} \Delta V_{DC} - K_{qC} \Delta C - K_{q\psi} \Delta \psi \quad (20)$$

$$\Delta v = K_5 \Delta \delta + K_6 \Delta E'_q + K_{vDC} \Delta V_{DC} + K_{vC} \Delta C + K_{v\psi} \Delta \psi \quad (21)$$

$$\Delta V_{DC} = K_7 \Delta \delta + K_8 \Delta E'_q + K_{DC} \Delta V_{DC} + K_{\Delta C} \Delta C + K_{\Delta \psi} \Delta \psi \quad (22)$$

where K_1 - K_8 , K_{DCP} , K_{PC} , $K_{p\psi}$, K_{qDC} , K_{qC} , $K_{q\psi}$, K_{vDC} , K_{vC} , $K_{v\psi}$, K_{DC} , $K_{\Delta C}$, and $K_{\Delta \psi}$ are linearization constants. The above linearizing procedure yields the following linearized power system model

$$\begin{bmatrix} \dot{\Delta\delta} \\ \dot{\Delta\omega} \\ \dot{\Delta E'_q} \\ \dot{\Delta E'_{fd}} \\ \dot{\Delta V_{DC}} \end{bmatrix} = \begin{bmatrix} 0 & 377 & 0 & 0 & 0 \\ \frac{K_1}{M} & -\frac{D}{M} & -\frac{K_2}{M} & 0 & -\frac{K_{pDC}}{M} \\ \frac{K_4}{T'_{do}} & 0 & -\frac{K_3}{T'_{do}} & \frac{1}{T'_{do}} & -\frac{K_{qDC}}{T'_{do}} \\ \frac{K_A K_5}{T_A} & 0 & -\frac{K_A K_6}{T_A} & \frac{1}{T_A} & -\frac{K_A K_{vDC}}{T_A} \\ \frac{K_7}{K_8} & 0 & \frac{K_9}{K_8} & 0 & \frac{K_9}{K_8} \end{bmatrix} \begin{bmatrix} \Delta\delta \\ \Delta\omega \\ \Delta E'_q \\ \Delta E'_{fd} \\ \Delta V_{DC} \end{bmatrix}$$

$$+ \begin{bmatrix} 0 & 0 & 0 \\ 0 & -\frac{K_{pC}}{M} & -\frac{K_{p\psi}}{M} \\ 0 & -\frac{K_{qC}}{T'_{do}} & -\frac{K_{q\psi}}{T'_{do}} \\ \frac{K_A}{T_A} & -\frac{K_A K_{vC}}{T_A} & -\frac{K_A K_{v\psi}}{T_A} \\ 0 & K_{\Delta C} & K_{\Delta\psi} \end{bmatrix} \begin{bmatrix} u_{PSS} \\ \Delta C \\ \Delta\psi \end{bmatrix} \quad (23)$$

In short;

$$P\Delta x = A\Delta x + B\Delta u \quad (24)$$

Here, the state vector X is $[\Delta\delta, \Delta\omega, \Delta E'_q, \Delta E'_{fd}, \Delta V_{DC}]^T$, and the control vector U is $[u_{PSS}, \Delta C, \Delta\psi]^T$. K_1 - K_9 , K_p , K_q , K_v and K_A are linearization constant.

III. PROBLEM FORMULATION

A. Stabilizer Structure

The commonly used lead-lag structure shown in Figs. 2 and 3 is chosen in this study. The transfer function of the stabilizer is

$$u = K \left(\frac{sT_w}{1+sT_w} \right) \left(\frac{1+sT_1}{1+sT_2} \right) \left(\frac{1+sT_3}{1+sT_4} \right) y \quad (25)$$

where u and y are the stabilizer output and input signals respectively, K is the stabilizer gain, T_w is the washout time constant, and T_1 , T_2 , T_3 , and T_4 are the stabilizer time constants. In this structure, T_w prespecified. The controller gain K and time constants T_1 , T_2 , T_3 and T_4 are to be determined. In this study, the input signal of the proposed damping stabilizers is the speed deviation, $\Delta\omega$.

B. Objective Function

A widely used conventional lead-lag structure for both excitation and FACTS-based stabilizers, shown in Figs. 2 and 3, is considered. In this structure, the washout time constant T_w is usually prespecified. In this study, several loading conditions represent nominal, heavy, without and with system parameter uncertainties are considered to ensure the robustness of the proposed stabilizers. In stabilizer design process, it is aimed to enhance the system damping of the poorly damped electromechanical mode eigenvalues at the entire range of the specified loading conditions. Therefore, the following objective function J is used.

$$J = \int_0^{t_{sim}} t (|\Delta\omega| + \alpha_1 |\Delta V_m| + \alpha_2 |\Delta V_{DC}|) dt \quad (26)$$

where t_{sim} is the simulation time, α_1 and α_2 are weighting factors, $\Delta\omega$ is the generator speed deviation, ΔV_m is the FACTS AC voltage deviation, and ΔV_{DC} is DC voltage deviation. It is aimed to minimize this objective function in order to improve the system response in terms of the settling time and overshoots.

C. Optimization Problem

In this study, it is aimed to minimize the proposed objective function J . The problem constraints are the stabilizer optimized parameter bounds. Therefore, the design problem can be formulated as the following optimization problem.

Minimize J

Subject to:

$$K_{ACP}^{\min} \leq K_{ACP} \leq K_{ACP}^{\max} \quad (27)$$

$$K_{ACI}^{\min} \leq K_{ACI} \leq K_{ACI}^{\max} \quad (28)$$

$$K_{DCI}^{\min} \leq K_{DCI} \leq K_{DCI}^{\max} \quad (29)$$

$$K_{DCP}^{\min} \leq K_{DCP} \leq K_{DCP}^{\max} \quad (30)$$

$$K_C^{\min} \leq K_C \leq K_C^{\max} \quad (31)$$

$$K_\psi^{\min} \leq K_\psi \leq K_\psi^{\max} \quad (32)$$

$$K_{PSS}^{\min} \leq K_{PSS} \leq K_{PSS}^{\max} \quad (33)$$

$$T_1^{\min} \leq T_1 \leq T_1^{\max} \quad (34)$$

$$T_2^{\min} \leq T_2 \leq T_2^{\max} \quad (35)$$

$$T_3^{\min} \leq T_3 \leq T_3^{\max} \quad (36)$$

$$T_4^{\min} \leq T_4 \leq T_4^{\max} \quad (37)$$

The proposed approach employs genetic algorithm to solve this optimization problem and search for optimal set of the controller parameters. In this study, PSS and FACTS-based damping controllers as discussed in the following combination cases:

Case 1: Without compensation (base case)

Case 2: FACTS internal AC and DC PI voltage controllers with PSS and C and ψ -based damping stabilizer.

D. Application of Genetic Algorithm

Based on the linearized power system model, Genetic Algorithm (GA) has been applied to the above optimization problem to search for optimal settings of the proposed stabilizer.

IV. SIMULATION RESULTS

To assess the effectiveness of the proposed stabilizers, two different loading conditions given in Table I were considered. Each loading condition is considered without and with parameter uncertainties as given in Table III. Parameters for the proposed stabilizers are given in Table II and Table III.

TABLE I
LOADING CONDITION

Loading	P_e (pu)	Q_e (pu)
Normal	1.0	0.015
Heavy	1.1	0.4

TABLE II
OPTIMAL PARAMETER SETTING OF THE SSSC-BASED STABILIZERS

Controller optimal parameter	C-based Stabilizer	ψ -based Stabilizer
T1	0.3049	0.0080
T2	0.5000	0.5000
T3	0.4625	0.1295
T4	0.5000	0.5000
K	39.07	51.40
KP _{AC}	595.9	328.1
KI _{AC}	31.87	795.7
KP _{DC}	291.6	160.7
KI _{DC}	922.7	825.2

TABLE III
OPTIMAL PARAMETER SETTING OF THE STATCOM-BASED STABILIZERS

Controller optimal parameter	C-based Stabilizer	ψ -based Stabilizer
T1	0.3049	0.0080
T2	0.5000	0.5000
T3	0.4625	0.1295
T4	0.5000	0.5000
K	39.07	51.40
KP _{AC}	595.9	328.1
KI _{AC}	31.87	795.7
KP _{DC}	291.6	160.7
KI _{DC}	922.7	825.2

A. Eigenvalues Analysis

The system eigenvalues with the proposed stabilizers' structures for nominal and heavy loading conditions are given in Tables IV-IX, respectively, where the first row represents the electromechanical mode eigenvalues and their damping ratios.

Case 1: Without Compensation (Base Case)

In this case, the power system is not equipped with any compensator. Eigenvalues and damping factors of electromechanical mode, in different loading conditions, are as following:

TABLE IV
EIGENVALUES (A) & DAMPING (B) OF NORMAL AND HEAVY LOADING CONDITIONS, BASE CASE (WITHOUT INSTALLATION OF PSS&FACTS DEVICES)

A	
nominal	Heavy
0.3±j4.96	0.49±j3.69

B	
nominal	Heavy
-0.0595	-0.1304

Case 2: FACTS internal AC and DC PI voltage controllers with PSS and C and ψ -based damping stabilizer.

TABLE V
SYSTEM EIGENVALUES OF NOMINAL LOADING CONDITION

System with SSSC No POD controllers	C-based Stabilizer	ψ -based Stabilizer
-1.701±j3.291	-4.742± j5.002	-6.325± j 3.108
-11.314	-3.3361± j 5.546	-3.017± j 1.8594
-5.187	-8.2703± j 13.46	-15.658± j 10.25
-0.1506	-30.681; -10.045	-14.906± j 2.056
-	-8.4381;-2.5001	-2.7756;-0.2223
-	-0.2010	-0.20

TABLE VI
SYSTEM EIGENVALUES OF HEAVY LOADING CONDITION

System with SSSC No POD controllers	C-based Stabilizer	ψ -based Stabilizer
-1.073±j5.71	-1.968± j3.989	-3.078± j1.50
-15.0978	-5.671± j 5.6945	-2.8856± j0.454
-9.2108	-9.743± j 74.848	-5.0821± j6.120
-0.1576	-31.119;-11.872	-9.9427± j13.06
-	-2.5485;-0.7464	-28.366;-0.2069
-	-0.201	-0.2

TABLE VII
SYSTEM EIGENVALUES OF NOMINAL LOADING CONDITION

System with STATCOM No POD controllers	C-based Stabilizer	ψ -based Stabilizer
-0.7174±j1.8546	-1.503± j2.499	-2.610± j2.2899
-13.5086	-4.157± j10.2611	-2.6630± j6.0705
-5.3029	-5.738± j23.4564	-8.2258± j17.831
-0.1540	-31.864;-14.186	-33.543;-13.5437
-	-9.6084;-2.362	-7.1361;-0.2005
-	-0.202	-0.0380

TABLE VIII
SYSTEM EIGENVALUES OF HEAVY LOADING CONDITION

System with STATCOM No POD controllers	C-based Stabilizer	ψ -based Stabilizer
-1.083± j 2.651	-1.2910± j1.7502	-2.697± j2.697
-1.7071	-4.1875± j11.557	-3.4708± j6.17
-13.0972	-5.6067±19.7289	-7.745± j14.34
-6.8040	-31.129;-13.4416	-33.62;-13.212
-	-10.4998;-3.4676	-7.671;-0.2023
-	-0.2062	-0.0337

TABLE IX
DAMPING OF SYSTEM ELECTROMECHANICAL MODE, SINGLE AND COORDINATED DESIGN (SSSC)

Loading	No control	C-based Stabilizer	ψ -based Stabilizer
Normal	0.4589	0.6880	0.8975
Heavy	0.4809	0.6525	0.9652

TABLE X
DAMPING OF SYSTEM ELECTROMECHANICAL MODE, SINGLE AND COORDINATED DESIGN (STATCOM)

Loading	No control	C-based Stabilizer	ψ -based Stabilizer
Normal	0.3608	0.5154	0.7517
Heavy	0.3783	0.5936	0.7992

B. Non Linear Time Domain Simulation

The single machine infinite bus system shown in Fig. 1 is considered for nonlinear simulation studies. 6-cycle 3- ϕ fault on the infinite bus was created, at all loading conditions given in Table I, to study the performance of the proposed controller. Figs. 4-9 show the rotor angle, the speed deviation response with above mentioned disturbance at nominal and heavy loading conditions respectively. From the figure it can be seen that the coordinated design approach provides the best damping characteristic and enhance greatly the first swing stability at two loading conditions. Response when designed individually and in coordinated manner at nominal and heavy loading conditions are compared and show in Figs. (4-9)a & b, respectively. It is clear that the control effort is greatly reduced with the coordinated design approach.

Case 1: Without compensation (base case)

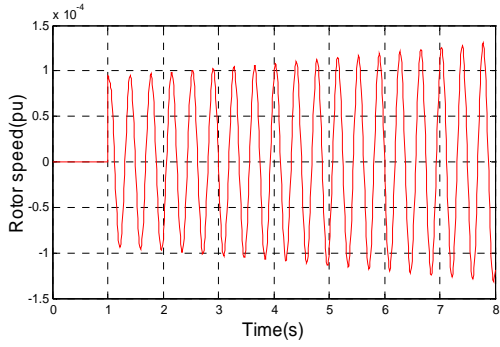

Fig. 4 Response of deviation of generator speed in nominal loading condition, without compensation

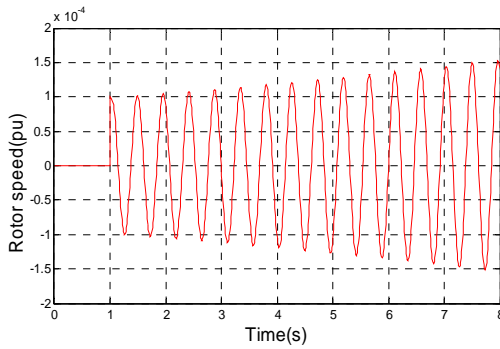
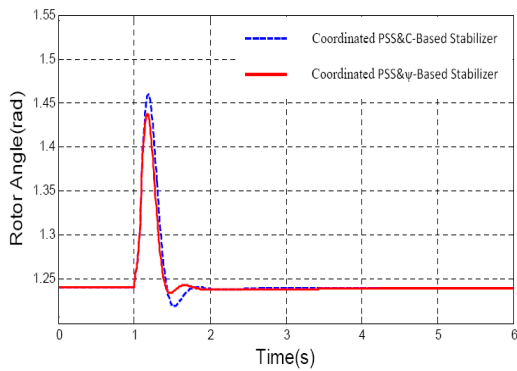
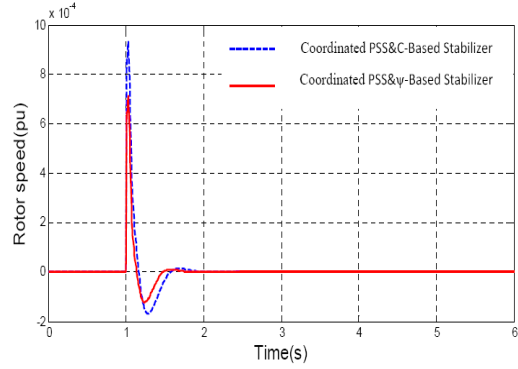

Fig. 5 Response of deviation of generator speed in heavy loading condition, without compensation

Case 2: FACTS internal AC and DC PI voltage controllers with PSS and C and ψ -based damping stabilizer.



(a)



(b)

Fig. 6 Machine rotor angle (a) & speed (b) response for a six cycles fault with nominal loading condition

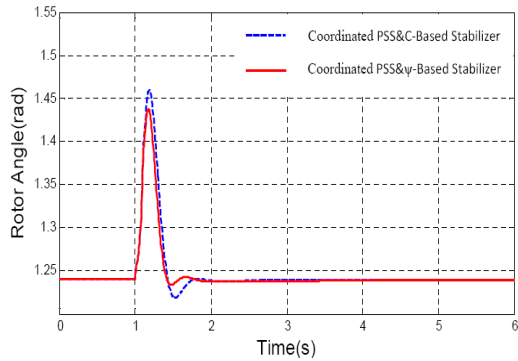

(a)

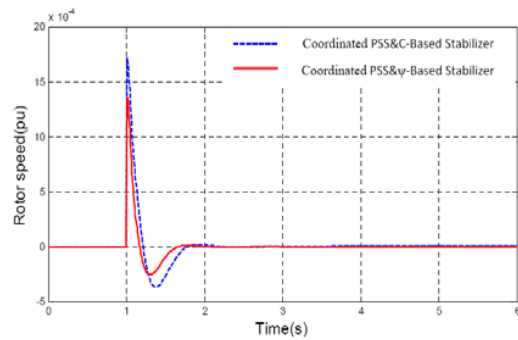

(b)

Fig. 7 Machine rotor angle (a) & speed (b) response for a six cycles fault with heavy loading condition (SSSC)

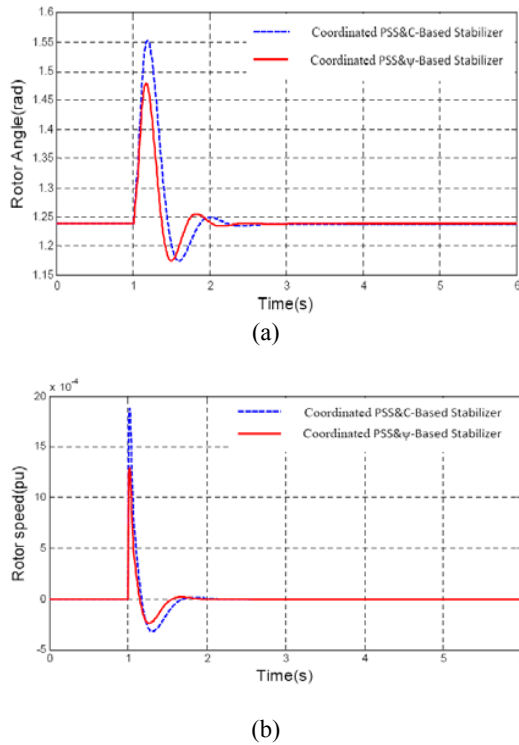

Fig. 8 Machine rotor angle (a) & speed (b) response for a six cycles fault with nominal loading condition

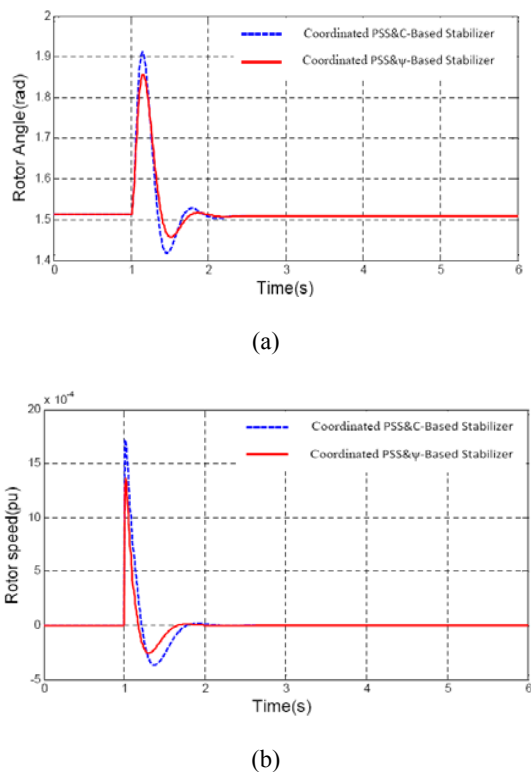

Fig. 9 Machine rotor angle (a) & speed (b) response for a six cycles fault with heavy loading condition

V. CONCLUSION

This paper has compared between the SSSC and STATCOM based-stabilizers is presented and discussed. The stabilizer design problem has been formulated as a multiobjective optimization problem, which was solved by genetic algorithms (GA). The proposed stabilizers have been applied and tested on power system under severe disturbance and different loading condition. It is also evident that the coordinated design of PSS and FACTS-based stabilizer provides great damping characteristics and enhance significantly the system stability compared to individual design. It is clear from the eigenvalues analysis that the system stability is greatly enhanced with the proposed stabilizers. The eigenvalues results presented show that the system stability is greatly enhanced with the coordinated design of the proposed stabilizers. The simulations results presented show that both FACTS devices improve the system stability, furthermore the SSSC-based stabilizer provide a better effectiveness than STATCOM-based stabilizer on damping power system oscillation. Moreover it can be seen that the coordinated PSS and ψ -based stabilizer provide better damping characteristics and enhances the first swing stability greatly compared to the coordinated PSS and C-based stabilizer case.

REFERENCES

- [1] Y.-Y. Hsu, S.-W. Shyue, and C.-C. Su, "Low Frequency Oscillation in Longitudinal Power Systems: Experience with Dynamic Stability of Taiwan's Power System," *IEEE Trans. Power Systems*, Vol. 2, No. 1, pp. 92-100, Feb.1987.
- [2] D. N. Koterev, C.W. Taylor, and W. A. Mittelstadt, "Model Validation for the August 10, 1996 WSCC System Outage," *IEEE Trans. Power Systems*, Vol. 14, No.3, pp.967-979, Aug.1999.
- [3] G. Rogers, *Power System Oscillations*, Kluwer, Norwell, MA,2000.
- [4] P. Kundur, M. Klein, G. J. Rogers, and M. S. Zywno, "Application of Power System Stabilizers for Enhancement of Overall System Stability," *IEEE Trans. PWRs*, Vol.4, No.2,1989, pp.614-626.
- [5] A. E. Hammad, "Analysis of Power System Stability Enhancement by Static VAR Compensators," *IEEE Trans.PWRs*, Vol.1, No.4, 1986, pp.222-227.
- [6] M. Noroozian and G. Anderson, "Damping of Power System Oscillations by Use of Controllable Components," *IEEE Trans. PWRD*, Vol. 9, No. 4, 1994, pp.2046-2054.
- [7] M. A. Abido and Y. L. Abdel-Magid, "Analysis and Design of Power System Stabilizers and FACTS Based Stabilizers Using Genetic Algorithms," 14th Power Systems Computation Conference PSCC-2002, Session 14, Paper 4, Seville, Spain, June 24-28, 2002, CD-ROM.
- [8] M. Noroozian, M. Ghandhari, G. Andersson, J. Gronquist, and I. Hiskens, "A robust control strategy for shunt and series reactive compensators to damp electromechanical oscillations," *IEEE Trans. On Power Delivery*, Vol. 16, No. 4, pp. 812-817, Oct. 2001.
- [9] H.F. Wang, "Design of SSSC damping controller to improve power system oscillation stability," *AFRICON*, 1999 IEEE, Vol. 1, pp. 495 - 500, 28 Sept.-1 Oct. 1999.
- [10] B.S. Rigby, N. S. Chonco, and R. G. Harley, "Analysis of a power DC-Link Voitie oscillation damping scheme using a voltage-source inverter," *IEEE Trans. on Industrial Applications*, Vol. 38, No. 4, pp. 1105-1113, Jul./Aug.2002.
- [11] N. Mithulanathan, C. A. Canizares, J. Reeve, and G. J. Rogers, "Comparison of PSS, SVC, and STATCOM Controllers for Damping Power System Oscillations," *IEEE Trans. PWRs*, Vol. 18, No. 2, 1993, pp.786-792.
- [12] H. F. Wang, "Interactions and Multivariable Design of STATCOM AC and DC Voltage Control," *Int. J. of Electrical Power and Energy Systems*, Vol. 25, 2003, pp. 387-394.

- [13] H. F. Wang, "Phillips-Heffron Model of Power Systems Installed with STATCOM and Applications," IEE Proc.-Gener. Transmi. Distrib., Vol. 146, No. 5, 1999, pp.521-527.
- [14] K. Kobayashi, M. Goto, K. Wu, Y. Yokomizu, and T. Matsumura, "Power System Stability Improvement by Energy Storage Type STATCOM," IEEE Bologna Power Tech Conference, Bologna, Italy, June 23-26, 2003.
- [15] Y. S. Lee and S. Y. Sun, "STATCOM Controller Design for Power System Stabilization with Sub-optimal Control and Strip Pole Assignment," Int. J. of Electrical Power and Energy Systems, Vol. 24, 2002, pp. 771-779.
- [16] N. C. Sahoo, B. K. Panigrahi, P. K. Dash, and G. Panda, "Application of a Multivariable Feedback Linearization Scheme for STATCOM Control," Electric Power Systems Research, Vol. 62, No. 1, 2002, pp. 81-91.
- [17] S. Morris, P. K. Dash, and K. P. Basu, "A Fuzzy Variable Structure Controller for STATCOM," Electric Power Systems Research, Vol. 65, No. 1, 2003, pp. 23-34.
- [18] K. R. Padiyar and V. S. Parkash, "Tuning and Performance Evaluation of Damping Controller for a STATCOM," Int. J. of Electrical Power and Energy Systems, Vol.25, 2003, pp.155-166.
- [19] L. Cong and Y. Wang, "Co-ordinated Control of Generator Excitation and STATCOM for Rotor Angle Stability and Voltage Regulation Enhancement of Power Systems," IEE Proc.-Gener. Transmi. Distrib., Vol. 149, No.6, 2002, pp.659-666.
- [20] "Modeling of power electronics equipment (FACTS) in load flow and stability programs," CIGRE TaskForce38-01-08,1998.
- [21] N.G.Hingorani and L.Gyugyi, Understanding FACTS, Piscataway, NJ: IEEE Press, 2001.
- [22] K.Sen."SSSC-Static Synchronous Series Compensator: Theory modeling and application," IEEE Trans. on Power Delivery, Vol.13, No.1, pp. 241-246, 1998.
- [23] L. Gyugyi, C. Schauder, and K.Sen, "Static Synchronous Series Compensator: A solid state approach to the series compensation of transmission lines," IEEE Trans. on Power Delivery, Vol.2, No.1, pp.406-417,1997.
- [24] B.S. Rigby, N. S. Chonco, and R. G. Harley, "Analysis of a power DC-Link Voitie oscillation damping scheme using a voltage-source inverter," IEEE Trans. on Industrial Applications, Vol. 38, No. 4, pp. 1105-1113, Jul./Aug.2002.
- [25] G.N. Pillai, A. Ghosh, and A. Joshi, "Torsional interaction between an SSSC and a PSS in series compensated power systems," IEE Proc. Gener. Transm. Distrib., Vol. 149, No. 6, pp. 653-658, Nov. 2002.

APPENDIX

Power system data in per unit value:

$$M=9.26; T_{d0}=7.76; D=0; x=0.973; x_d=0.19;$$

$$x_q=0.55; R=0.234; X=0.997; g=0.249; b=0.262; Kc=1.0; T$$

$$c=0.05; |E_{fd}| \leq 7.3 \text{ pu}; V_{dc}=1, K_A=20, T_A=0.01, T_w=5.$$