

# CACSC tool for Automatic Design of Robust Controllers for Hydropower Plants

Jose J. CarreñoZagarra and Rodolfo Villamizar Mejía

**Abstract**—This work describes a CACSD tool for automatic design of robust controllers for hydraulic turbines. The tool calculates the optimal  $H_\infty$  controller using the MATLAB hinfopt function and it serves as a practical and effective solution for the laborious task of designing a different controller for each type of turbine and generator, and different parameters and conditions of the plant. Results of the simulation of a generating unit subject to parameters variation show the accuracy and efficiency of the obtained robust controllers.

**Keywords**—Robust Control, Hydroelectric System, Hydraulic Turbine, Control  $H_\infty$ , CACSD

## I. INTRODUCTION

HYDROELECTRIC systems, as efficient mechanisms of electricity generation in isolated consumption centers are presented as an excellent alternative by their operating costs and technological improvement that makes the available hydraulic resources being used more efficiently. However, the regulation of these systems that are composed of both electromechanical and hydraulic dynamics is a complex task. Under stationary operating conditions, such that the system frequency can be assured in a desired region. During a transient period, it is required that the system be controlled and retain stable under severe disturbances.

In order to know effectively the energy's demand, hydroelectric plants must be equipped with modern systems of regulation to ensure low losses and maximum use of energy. In practice, it is common to find Computer-Aided Control Systems Design (CACSD) for several applications of automatic control (including aerospace, robotic applications, etc.). However, it is unusual to use software tools for the automatic design of hydraulic turbines controllers since studies usually focus on obtaining new models that describe the dynamics of the plant and on the employment and improvement of various control strategies that are commonly applied.

The active power and the speed must be regulated taking into account the type of turbine, nominal power of generator, flow and pressure. The difficulty of designing controllers for hydraulic plants is due to the dynamics of the turbine and associated hydraulic circuit: it's a non-minimum phase nonlinear system [1]. Therefore, a software tool would be very useful in so far as allows to determine the parameters of the controller of the hydraulic turbine and ensuring the proper operation of the plant. The main function of the controller or governor of the hydroelectric power plant is to regulate the

speed or number of revolutions per minute of the turbine and hence the frequency of the voltage and the active power. This function requires information about the speed of the turbine rotor and the electrical power to determine the appropriate opening of the water inlet valve.

PID controllers are usually used to control the turbine and its implementation may include wide variety of configurations: from purely mechanical or electromechanical controllers to electronic controllers. However, due to the considerable advantage that the robust  $H_\infty$  control theory shows e.g. as robustness to disturbances in the plant and unmodeled dynamics, the current work is addressed to the elaboration of an useful computational tool for the automatic design of controllers  $H_\infty$  for hydraulic turbines.

## II. MATHEMATICAL MODEL OF THE SYSTEM

The model of the plant consists of the modeling of the performance electric and hydraulic system, the turbine model and the hydraulic circuit of the central and the dynamics of the rotor. Figure 1 shows the complete control system of a hydroelectric power station including the speed regulator [2].

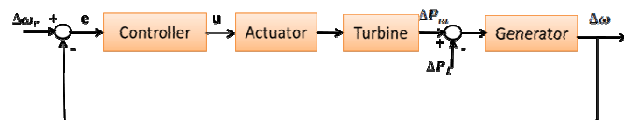

Fig. 1 Block diagram of speed control system

### A. Hydroelectric Actuator Model

The actuator is a valve that produces the reference for the plant according to the control signal. The model of this element is shown in Figure 2.

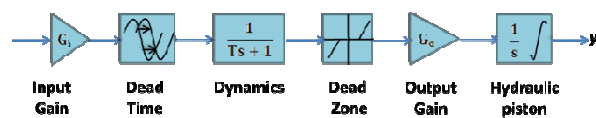

Fig. 2 Electrohydraulic actuator system model [2].

Because the dynamics in the electrohydraulic positioning system are very fast when compared with the dynamics in the turbine, can be represented as a first-order function [2]

$$\frac{y}{y_{ref}} = \frac{1}{T_a s + 1} \quad (1)$$

### B. Turbine and Hydraulics Model

The characteristics and behavior of a hydraulic system are determined by three basic relationships: speed of water in the

J. J. Carreño is with the Electrical Engineering Department, Universidad Industrial de Santander, Cra 27 # 9 Bucaramanga, Colombia (phone: (57) 301-632-2610; e-mail: jota132@hotmail.com).

R. Villamizar, is with the Electrical Engineering Department, Universidad Industrial de Santander, Cra 27 # 9 Bucaramanga, Colombia (phone: (577) 6344000; ext: 1220, 2488; e-mail: rovimlam@uis.edu.co).

penstock, turbine mechanical power and wave equation of flow in a duct [3], [4], [5].

The equation of flow (water velocity) in the pressure pipe is given in (2)

$$\bar{U} = \bar{G}\sqrt{\bar{H}} \quad (2)$$

Where  $\bar{U}$  is the watervelocity,  $\bar{G}$  is the position of the inlet water and  $\bar{H}$  is the head in turbine. For its part, the mechanical power is proportional to the product of pressure and flow, hence:

$$\bar{P}_{mec} = \bar{U}\bar{H} \quad (3)$$

And the flow of water through a closed conduit complies with the following physical relations [6]:

$$\frac{\partial U}{\partial t} = -g \frac{\partial H}{\partial x} \quad (4)$$

$$\frac{\partial U}{\partial x} = -\alpha \frac{\partial H}{\partial t} \quad (5)$$

Where  $\alpha$  is a constant which depends on the physical and chemical characteristics of water and the material of the pipe.

From these two equations (4) and (5) determines the transfer function that connects the flow of the turbine and his jump, which determines the dynamics of the hydraulic circuit and it is described as:

$$F(s) = \frac{\bar{U}(s)}{\bar{H}(s)} \quad (6)$$

This transfer function is determined by the tunnel parameters, the surge tank (or oscillation tank to absorb the overload or water hammer when are opened or closed the valves [7]) and the pressure pipe of the hydraulic plant [3], [6]. Table I presents the four (4) models proposed by Kundur [3] to describe the dynamics of pipes and ducts of the central and Table II details each of the parameters that describe these transfer functions.

TABLE I  
HYDROELECTRIC SYSTEM MODELS USED BY KUNDUR [3], [6]

Model	F(s)
With no Surge Tank effects and a non-elastic water column in the penstock	$-\frac{1}{T_{WT}S}$
With no Surge Tank aelastic water column in the penstock	$-\frac{1}{\varphi_T + z_T \tanh(T_{eT}S)}$
With Surge Tank effects and a non-elastic water column in the penstock	$-\frac{1 + \frac{G(s)}{z_T} T_{eT}}{\varphi_T + z_T T_{eT} + G(s)}$

With Surge Tank effects and aelastic water column in the penstock	$-\frac{1 + \frac{G(s)}{z_T} \tanh(T_{eT}S)}{\varphi_T + z_T \tanh(T_{eT}S) + G(s)}$
---	--

The G (s) appearing in some of the models refers to the transfer function between the tunnel and according to [3], [6] the surge tank and is given by the equation (7)

$$G(s) \approx \frac{\varphi_C + T_{WT}S}{1 + \varphi_C C_A S + T_{WT} C_A S^2} \quad (7)$$

On the other hand, linearizing (2) and (3) using the role of Taylor we get the following linear equations [3]:

$$\Delta \bar{U} = 0.5 \Delta \bar{H} + \Delta \bar{G} \quad (8)$$

$$\Delta \bar{P}_m = 1.5 \Delta \bar{H} + \Delta \bar{G} \quad (9)$$

The block diagram of Figure 3 represents the transfer function of a hydraulic turbine which is obtained from the linearization at a point of operation.

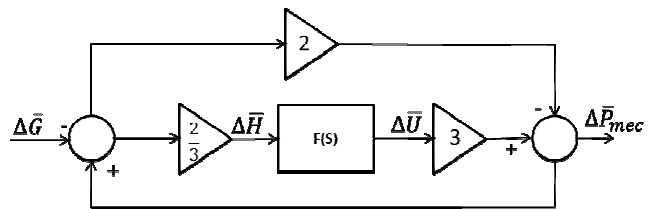

Fig. 3. Block diagram of the linear of turbine

Hyperbolic function resulting in models that consider elastic columns of water in pressure pipe can be approximated through the linear term in the equation (10).

$$\text{Tanh}(T_{eT}S) = \frac{sT_{eT} \prod_{n=1}^{\infty} \left[ 1 + \left( \frac{sT_{eT}}{n\pi} \right)^2 \right]}{\prod_{n=1}^{\infty} \left[ 1 + \left( \frac{2sT_{eT}}{(2n-1)\pi} \right)^2 \right]} \quad (10)$$

The value of n determines the accuracy with which the characteristics of the hydroelectric control system are preserved[3], [6]. With n = 0 would be excluding the elastic effect of water in the pipe, whereas in this way an inelastic model. However, we can consider n = 1 as one sufficient approximation to describe almost precisely the behavior of water in the pipe.

TABLE II  
LIST OF PARAMETERS [6]

PARAMETERS	MEANING
$g$	Acceleration due to gravity (9.81m/s <sup>2</sup> ).
$T_{(WT,WC)}$	Water starting time in s. (WC: in tunnel; WT: in penstock).
$C_A$	Storage constant of surge tank in s.
$\varphi_{(C,T)}$	Coefficient of friction in p.u. (WC: in tunnel; WT: in penstock).

$Z_r$	Hydraulic impedance in penstock in p.u.
$T_{er}$	Elastic time in penstock in s.

$$S(s) = \frac{1}{1 + G(s)K(s)} \tag{15}$$

$$T(s) = \frac{G(s)K(s)}{1 + G(s)K(s)} \tag{16}$$

**C. Generator Dynamics Model**

If the generator unit operates isolated, the dynamic process of generator unit considering load characteristic is [1]:

$$\frac{\Delta\omega}{\Delta P_m - \Delta P_L} = \frac{1}{T_m s + D_p} \tag{11}$$

where  $\Delta P_L$  is the load change (in per unit),  $T_m$  is the mechanical starting time of generator  $D_p$  is the damping coefficient of the grid (in per unit), is which usually between 0.5 and 2.5. The constant  $T_m$  is a design parameter that determines the maximum value of the speed achieved on a group after a load rejection.

On the other hand, the active power consumed by the load generally will have two components: one under tension ( $P_L$ ) and another subsidiary of the variation of frequency [2]:

$$P_e = P_L + D\Delta\omega \tag{12}$$

**III.  $H_\infty$  CONTROLLER DESIGN**

The controller design method  $H_\infty$  is related to the minimization of the value peak in the frequency response of some function in closed-loop [8]. For such purpose we introduce weighting functions  $W_i$  in the system to reflect the design goals and also the knowledge that has input and output signals. These signals will be bounded because in the calculation of the controller robust  $H_\infty$ , the  $\| \cdot \|_\infty$  norm of each signal has its upper limit unit [9], [10].

The inclusion of the weighting functions in a general feedback configuration can be seen in Figure 4. As can be seen the input signals are respectively the signal reference ( $r$ ), ( $n$ ) noise and disturbance to the output; and the weighted outputs of the system are  $z_S$ ,  $z_U$  y  $z_T$ .

The objectives and goals of the design should be clearly specified and evaluated before the plant model to analyze its acceptance. Considering the generalized system  $P(s)$  shown in Figure 5 the problem of design of  $H_\infty$  controller is to find all admissible compensators  $K_\infty(s)$  to stabilize internally the system and minimize the norm:

$$\|T_{zw}\|_\infty = \text{Sup}_w \bar{\sigma}[T_{zw}] \tag{13}$$

Where  $T_{zw}$  denotes the matrix transfer function from  $w$  to  $z$ . In terms of mixed sensitivity the expression of the resulting closed loop transfer function  $T_{zw}(s)$  is as follows:

$$T_{zw}(s) = \begin{bmatrix} W_S(s)S(s) \\ W_U(s)K(s)S(s) \\ W_T(s)T(s) \end{bmatrix} \tag{14}$$

Where  $S(s)$  is the sensitivity transfer function and  $T(s)$  is the complementary sensitivity transfer function:

In these applications the greatest difficulty consists in the selection of the weighting functions that allow certain requirements of stability and performance. Although there exist no systematic method in the  $H_\infty$  design literature to arrive at such other appropriate weighing filters [11] the result of the design will depend significantly on these weighting functions.

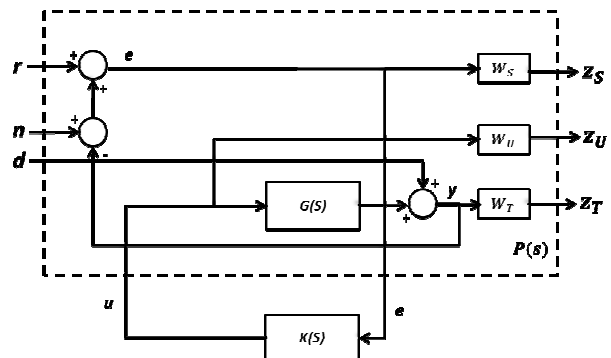

Fig. 4 General configurations for  $H_\infty$  control problems

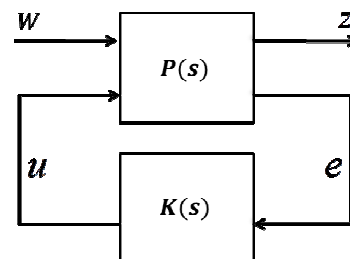

Fig. 5 Generalized plant

**A.  $W_T$  Calculation**

The function  $W_T(s)$  is used to make robust the system against the uncertainties presented by the inaccuracy of the linearized model and variation of the parameters of the plant. It usually takes low values at low frequencies and high values at high frequency values.

To ensure a small gain in high frequency in the complementary sensitivity function and provide a good robust stability for control system, we opted for the following weighting function:

$$W_T = \frac{0.1 * (s + 1)}{\left(\frac{s}{100} + 1\right)} \tag{17}$$

This weighting function was selected after conducting several tests with other transfer functions and turned out to be

a good option for hydroelectric power centrals because provide good stability robust to the control system, allowing an excellent performance to parametric variations of the plant.

### B. $W_S$ Calculation

It provides an adequate attenuation for perturbations of low frequency and a precise monitoring of the step slogans. Modeling errors and the bandwidth of the actuators generally impose this weight function to take low values at high frequency. For the selection of this function of weight Martínez, Ortega and Rubio [10], [12] [13] proposed a  $W_S$  in the following way:

$$W_S(s) = \left[ \frac{\sqrt[N]{\alpha} s + 10^{(k-1)} * \omega_T}{s + \sqrt[N]{\beta} * 10^{(k-1)} * \omega_T} \right]^N \quad (18)$$

In which:

$\alpha = 0.5$  High frequency gain.

$\beta = 10^{-4}$  Low frequency gain.

$\omega_T = 10$  rad/s  $W_T$  Cutoff frequency.

$K = 1.1$  It determines the cutoff frequency of the function.

$N = 1$  It determines the slope of the poles and zeros.

When using those parameters we can obtain the next function:

$$W_S(s) = \frac{0.5s + 10^{1.1}}{s + 10^{-2.9}} \quad (19)$$

This function reduces the sensitivity about 80db ( $1/10^4$ ) ensuring adequate attenuation for perturbations of low frequency and precise monitoring of the entry.

### C. $W_U$ Calculation

This function is intended to reduce the over oscillation of temporal response affecting the speed of the same. Likewise, the inclusion of  $W_U$  allows avoiding numerical problems in the calculation of the controller.

To avoid large signals can deteriorate the actuator was chosen the following weighting function:

$$W_U = \frac{30s}{s + 2} \quad (20)$$

## IV. SIMULATION RESULTS

To automatically generate the robust controllers, the CACSD tool calculates the optimal  $H_\infty$  controller combining the MATLAB hinfopt function with the parameters of the power plant, the choice of one of the four (4) linear models of turbines and the three (3) functions of weighting proposed.

To verify the effectiveness of the controller obtained by the tool software in Table III appears the most representative of the hydroelectric Zavrelje Croatian parameters.

TABLE III  
THE HYDROELECTRIC ZAVRELJE PARAMETERS

PARAMETERS	VALUE
Base head	76 m.
Base flow	3.2 m <sup>3</sup> /s.
Rated power	2.1 MW.
Nominal speed	600 r.p.m.
Time constant of the actuator	0.22 s.
Time constant of the generator	5 s.
Damping coefficient	2.0
Diameter of the pipe	1.3 m.
Water velocity	1034 m/s.

The transfer function that describes the dynamic behavior of the nominal plant is as follows:

$$P(s) = \frac{-0.3134s^3 + 1.4267s^2 - 8.6985s + 9.9}{0.1567s^3 + 1.4484s^2 + 4.3492s + 10.05} \quad (21)$$

This plant uses a PID controller whose parameters are obtained by closed-loop poles of the turbine parameters by analytical formulas derived from a wide range of operating points of the turbine [2].

The robust controller is calculated using the computational tool is reduced to a fourth-order controller, so it can be implemented more easily, resulting in the following transfer function:

$$K(s) = \frac{31.34s^3 + 74.19.25s^2 + 318.68s + 122.31}{s^4 + 24.17s^3 + 39.93s^2 + 194.86s + 0.245} \quad (22)$$

The simulation results using the PID controller with a non-linear model of the plant used by the authors and the actual system responses are presented in figures 6 and 7. While the figures 8 and 9 show the results obtained with the proposed robust controller to assume a model without surge tank with elastic columns of water in the pipe forced.

To compare these results one can conclude that the  $H_\infty$  controller proposed in the present paper presents a better performance than the employed in the hydroelectric Zavrelje PID controller, noting clearly that as this reaches its response in steady state (in terms of speed of the turbine) to 30 seconds, the  $H_\infty$  controller makes it in 15 seconds. The latter presents a higher response speed and a good follow-up of the reference signal.

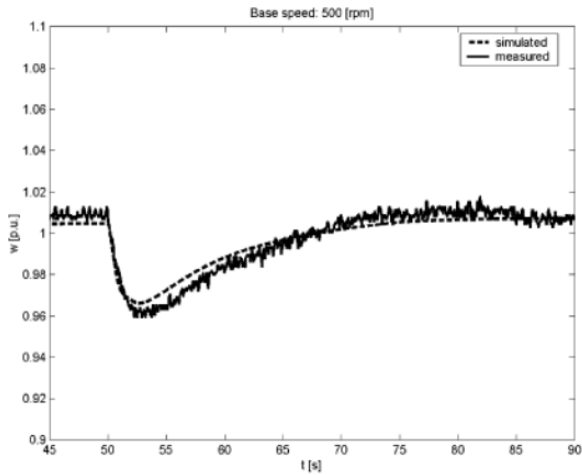

Fig 6 Speed of the turbine with PID controller

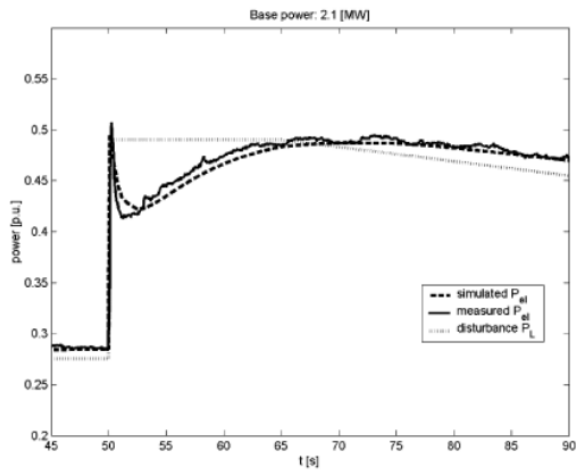

Fig. 7 Active Power with PID controller

In addition, we can put two very important facts: as a first step the linear model used to calculate the optimal  $H_{\infty}$  controller is as accurate as the non-linear model used by Strah, Kuljaca and Vukic [2] to simulate the performance of your PID controller; on the another hand, using the procedure proposed by these experts for the design of turbine controllers tends to be of greater complexity than the procedure proposed in the present work for automatically designing  $H_{\infty}$  controllers. This is because the synthesis of  $H_{\infty}$  controllers focuses on the selection of the appropriate weighting functions, and for this case (or put another way, for this type of plant) weight functions selected are conducive to the three models of power plants.

On the other hand, to verify the robustness of the controller, in Figure 10 we simulate the variation of the parameters of the pipeline that affects the dynamics of the control system. For the present analysis was arbitrarily considered a parametric uncertainty of 15% from the nominal values of the diameter, thickness, coefficient of friction of the forced pipe.

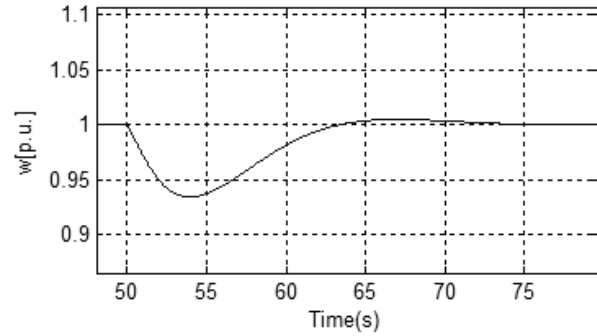

Fig 8 Speed of the turbine with  $H_{\infty}$  controller

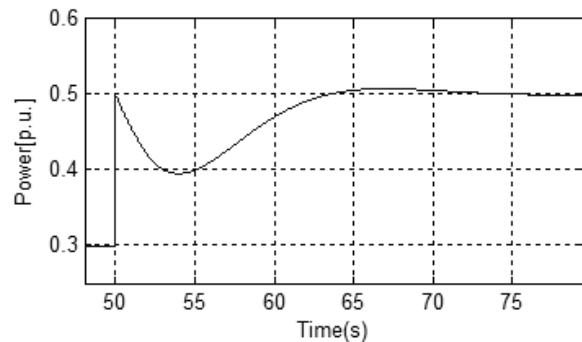

Fig. 9 Active Power with  $H_{\infty}$  controller

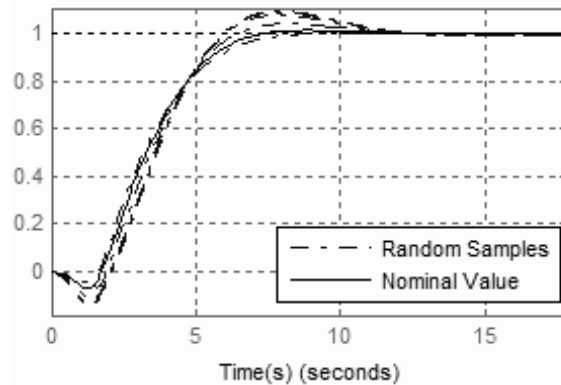

Fig. 10 Robustness of the  $H_{\infty}$  controller

## V. CONCLUSION

While the existing work on the modeling of hydroelectric power centrals and its control systems manifest the problem of adjusting speed regulators, the present computational tool automatically generates linear and efficient turbine controllers, to be implemented in the industry and they do not need be adjusted.

Comparing the results with a PID controller designed for a hydroelectric micro with the linear controller obtained with this tool, it is clear to see that hydraulic system presents a better performance and better robust stability when using  $H_{\infty}$  controller formulated.

On the other hand, although nonlinear models allow the representation of hydroelectric power plants, linearized models facilitate the control system stability study. This type of models only would be useful for power stations to do not submit large load changes. However, the control strategy  $H_\infty$  is robust enough to consider the dynamics unmodeled plant, standing perturbations and uncertainties due to variation in model parameters. In a future work could be considered both, the use of non-linear models of turbines and the use of a genetic algorithm or other method of optimization to select the appropriate weighting functions for the design of robust controllers.

#### ACKNOWLEDGMENT

The authors would like to acknowledge the financial support provided by the Department of Research and Extension Faculty (DIEF, for its acronym in spanish), of the Universidad Industrial de Santander, Colombia.

#### REFERENCES

- [1] F. Hong-qing, S. Zu-yi, "Modelling and Simulation of Hydraulic Transients for Hydropower Plants" in *Plastics*, 2nd ed. vol. 3, J. Peters, Ed. New York: McGraw-Hill, pp. 15-64, 2005.
- [2] B. Strah, O. Kuljaca y Z. Vukic, "Speed and Active Power Control of Hydro Turbine Unit. *IEEE Transactions on energy conversion*, vol. 20, N°2, Junio 2005.
- [3] Kundur, Prabha. "Power system Stability and control". McGraw-Hill M Professional. 1994.
- [4] R. Oldenburger, J. Donelson, "Dynamic Response of Hydroelectric Plant". *1962 AIEE Transactions on Power Apparatus and systems*, vol. 81, p. 403-409, October 1962.
- [5] Working Group on Prime Mover and Energy Supply Models for System Dynamic Performance Studies, "Hydraulic turbine and turbine control models for system dynamic studies" *IEEE Trans. On Power Systems*, vol. 7, No. 1, pp. 167-179, Feb. 1992.
- [6] O.D. Quiroga, "Modelling and nonlinear control of voltage frequency of hydroelectric power plants". Universitat Politècnica de Catalunya, Cataluña, 2000.
- [7] Working group on Prime Mover and energy supply models for system dynamic performance studies. 1992. "Hydraulic turbine and turbine control models for system dynamic studies", Vol. 7, N°1, Febrero 1992.
- [8] R. Rocha, L. S. Martins, "A Multivariable  $H_\infty$  Control for Wind Energy Conversion System" *IEEE Conference On Control Applications*, 2003.
- [9] M. López, F. Rodríguez, "Control Adaptativo y Robusto". 1996. Universidad de Sevilla. Sevilla.
- [10] Corchero M.A., Ortega M.G. y Rubio F.R. Aplicación del control robusto  $H_\infty$  a una planta solar. Depto. Ingeniería de sistemas y automática, Escuela superior de ingenieros. Universidad de Sevilla.
- [11] K. Natarajan, "Robust PID controller design for hydroturbines," *IEEE Trans. On Energy Conversion*, vol. 20, N°3, pp. 661-667, Sep. 2005.
- [12] Cámara J.F., Castaño F., Ortega M.G. y Rubio F.R. Controlador mediante sensibilidad mixta S/KS/T aplicado a una planta piloto. Depto. Ingeniería de sistemas y automática, Escuela superior de ingenieros. Universidad de Sevilla.
- [13] M. G. Ortega, F. R. Rubio, "Systematic Design of Weighting Matrices for the  $H_\infty$  Mixed Sensitivity Problem". *Journal of Process Control*, Vol. 14, p. 89-98, 2004.