

# BER Performance of UWB Modulations through S-V Channel Model

Risanuri Hidayat

**Abstract**—BER analysis of Impulse Radio Ultra Wideband (IR-UWB) pulse modulations over S-V channel model is proposed in this paper. The UWB pulse is Gaussian monocycle pulse modulated using Pulse Amplitude Modulation (PAM) and Pulse Position Modulation (PPM). The channel model is generated from a modified S-V model. Bit-error rate (BER) is measured over several of bit rates. The result shows that all modulation are appropriate for both LOS and NLOS channel, but PAM gives better performance in bit rates and SNR. Moreover, as standard of speed has been given for UWB, the communication is appropriate with high bit rates in LOS channel.

**Keywords**—IR-UWB, S-V Channel Model, LOS NLOS, PAM, PPM

## I. INTRODUCTION

SINCE FCC has proposed 7.5 GHz (3.6-10.1 GHz) bandwidth and IERP (Isotropic Effective Radiation Power) regulation for UWB wireless communication[1], UWB performance for communication has been studied [2]-[12]. It has been studied binary modulations for impulse radio include pulse position modulation (PPM) [2][3] and pulse amplitude modulation (PAM) [4]. Bipolar pulse waveform and position modulation and biorthogonal PPM has introduced [5][6] that both apply antipodal and position modulation on Gaussian pulses.

BER performance for impulse radio ultra wideband (IR-UWB) systems in multipath propagation channels has been introduced [5][6][7][8][9]. A statistical channel model is established for the ultra-wide bandwidth [10][11] to realize actual condition. The channel model has been modified from Saleh-Valenzuela (S-V) for UWB signal application [12].

This paper presents the analysis of modulations of UWB through modified S-V channel and AWGN noise especially in bit rates and BER by a simulation, implementing PAM and PPM. The UWB pulse used in this paper is Gaussian monocycle pulse introduced in [13], while the channel model used in this paper is a modified Saleh-Valenzuela [12][14][15].

## II. UWB PULSE

Some references have represented several formulas of Gaussian pulse [13] as an Impulse Radio-UWB. A monocycle

pulse is the first derivative of Gaussian pulse. The Gaussian pulse has formula (1), while the monocycle is given in (2).

$$x(t) = A_1 \cdot e^{-2\left(\frac{\pi t}{T_c}\right)^2} \quad (1)$$

$$x^{(1)}(t) = \frac{dx(t)}{dt} = A_2 t \cdot e^{-2\left(\frac{\pi t}{T_c}\right)^2} \quad (2)$$

where  $T_c = 1/f_c$  is the width of the pulse. The values  $A_1$  and  $A_2$  are amplitudes. The Federal Communications Commission (FCC) has recently approved the deployment of UWB on an unlicensed basis in the 3.1–10.6 GHz band subject to a modified version of Part 15.209 rules as in Fig. 1 [1]. The essence of this regulation is to limit the power spectral density (PSD) measured in a 1-MHz bandwidth at the output of an isotropic transmit antenna.

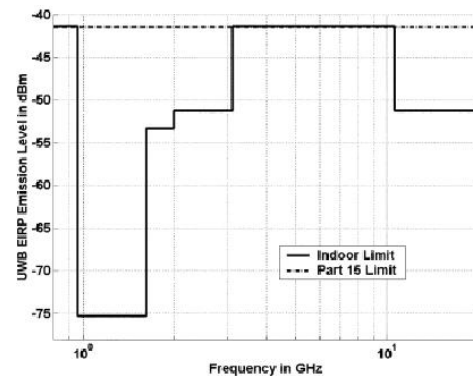

Fig. 1 UWB spectral mask and FCC Part 15 limits

## III. UWB PULSE MODULATIONS

A number of modulation schemes may be used with IR-UWB systems. The potential modulation schemes include both orthogonal and antipodal schemes. By far the most common method of modulation in the literature is pulse position modulation (PPM) where each pulse is delayed or sent in advance of a regular time backward shift in time [2][3]. Another common method of modulation is to invert the pulse: that is, to create a pulse with opposite phase, called pulse amplitude modulation (PAM) [4].

### A. Pulse Amplitude Modulation

Pulse Amplitude Modulation (PAM) is implemented by binary pulse modulation, which is presented using two

Risanuri Hidayat is with the Electrical Engineering Department, Faculty of Engineering, Gadjah Mada University, Yogyakarta, 55281 Indonesia (e-mail: risanuri@te.ugm.ac.id).

antipodal Gaussian pulses. The transmitted binary baseband pulse that is modulated information signal (t) is expressed as [4]

$$x(t) = d_j \cdot w_{tr}(t) \tag{3}$$

where  $w_{tr}(t)$  represents the UWB pulse waveform,  $j$  represents the bit transmitted that  $d_j = -1, j=0$  and  $d_j = +1, j=1$

Fig 2 (a) shows the pulse amplitude modulation of the Gaussian monocycle pulse waveform expressed in (2) with  $T_c = 2.22 \times 10^{-1}$  ns. Fig. 2 (b) shows the normalized Power Spectral Density (PSD) of the derivative of pulse. When a pulse is transmitted, due to the derivative characteristics of the antenna, the output of the transmitter antenna can be modelled by the first derivative of the pulse [4]. The derivative can be achieved by the basics of differential calculus

$$x^{(1)}(t) = \lim_{dt \rightarrow 0} \frac{x(t+dt) - x(t)}{dt} \tag{4}$$

PSD of the deterministic power signal, w(t), is

$$P(f) = \lim_{T \rightarrow \infty} \left( \frac{|X(f)|^2}{T} \right) \tag{5}$$

where T is the pulse spacing interval.  $X(f)$  is the Fourier transform of the pulse, i.e.  $x(t)$ .  $P(f)$  has units of watts per hertz. When  $X(f)$  is attained, the peak emission frequency, i.e.  $f_M$ , can be found as the frequency at the maximum value of  $|X(f)|$ . The normalized PSD is used to comply with the FCC spectral mask of the pulse that is transmitted by antenna [1][16][17]. The normalized PSD can be defined as follows

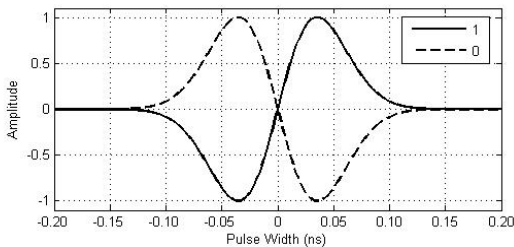

(a) BPAM pulse shapes

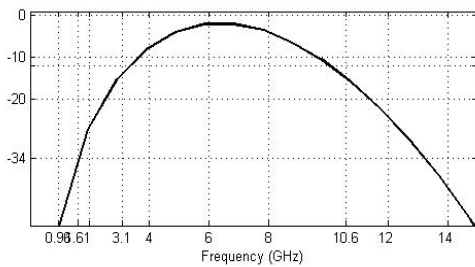

(b) Frequency domain

Fig. 2 BPAM pulse shapes for '1' and '0' bits and its frequency domain

$$|P(f)| = \frac{|X(f)|^2}{|X(f_M)|^2} \tag{6}$$

Fig. 2 (b) shows that the pulses have normalized PSD in 3.1-10.6 GHz frequency band that fulfil the FCC rules of UWB communication as shown in Fig. 1.

### B. Pulse Position Modulation

Pulse position modulation (PPM) makes the chosen bit be transmitted influences the position of the UWB pulse. That means that while bit '0' is represented by a pulse originating at the time instant 0, bit '1' is shifted in time by the amount of  $\delta$  from 0. The PPM signal can be represented as

$$x(t) = w_{tr}(t - \delta d_j) \tag{7}$$

where  $w_{tr}(t)$  is expressed in (2),  $d_j$  depends on the bit chosen to be transmitted, such as

$$d_j = \begin{cases} 0, & j=0 \\ 1, & j=1 \end{cases} \tag{8}$$

The value of  $\delta$  is chosen according to the autocorrelation characteristics of the pulse. When standard PPM with orthogonal signals is implemented, the optimum value for  $\delta$  ( $\delta_{opt}$ ) will be the one which satisfies

$$\rho(\delta_{opt}) = \int_{-\infty}^{+\infty} w_{tr}(t) \cdot w_{tr}(\delta_{opt} + t) dt = 0 \tag{9}$$

The theoretical performance in an additive white Gaussian noise channel can be achieved with non-overlapping, orthogonal pulses, specifically, the modulation index  $\delta \leq T_c$  [4]. Fig. 3 shows a particular case of PPM transmission where data bit '0' is sent delayed by a fractional time interval  $\delta < T_c$ , and data bit '1' is sent at the nominal time, which is implemented in this research. Fig. 3 implements the Gaussian monocycle pulse defined as in (2) with  $T_c = 2.22 \times 10^{-1}$  ns. The normalized Power Spectral Density (PSD) of the derivative of pulse is the same as in Fig. 2 (b) since the pulse waveform is the same.

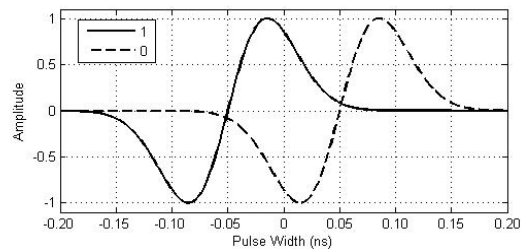

Fig. 3 PPM pulse shapes for '1' and '0' bits

### IV. THE MODIFIED S-V CHANNEL MODEL

There are several channel models used for analyzing wireless communication system that is designed for specific situation such as indoor and outdoor environment. For the time-of-arrival statistics, the model of Saleh-Valenzuela (S-V), which is used as the channel measurements, shows multipath arriving in clusters [14]. Since UWB waveforms

can be up to 7.5 GHz wide, for example, any paths separated by more than about 133 psec. (equivalent to 4 cm path length difference) can be individually resolved at the receiver [15]. The realistic channel for IEEE 802.15 study group 3a has been developed by Saleh-Valenzuela (S-V model) and proposed for the real indoor channel model, where the clusters and rays are multi-path components [12]. This multi-path channel can be expressed as

$$h(t) = \sum_{l=0}^L \sum_{k=0}^K \alpha_{k,l} \delta(t - T_l - \tau_{k,l}) \quad (10)$$

where  $\alpha_{k,l}$  is the multipath gain coefficient,  $T_l$  is the delay of the  $l^{\text{th}}$  cluster, and  $\tau_{k,l}$  is the delay of the  $k^{\text{th}}$  multipath component relative to the  $l^{\text{th}}$  cluster arrival time ( $T_l$ ).

As suggested in [12],  $\alpha_{k,l} = p_{k,l} \beta_{k,l}$  is adopted, where  $p_{k,l}$  is equally likely to take on the values of  $\pm 1$ , and  $\beta_{k,l}$  is the lognormal fading term, due to the simplicity of the real channel coefficients, and to avoid the ambiguity of phase for an UWB waveform.

The proposed channel model uses the definitions as previously described in the S-V model, and is repeated here for completeness.  $T_l$  is the arrival time of the first path of the  $l$ -th cluster;  $\tau_{k,l}$  is the delay of the  $k$ -th path within the  $l$ -th cluster relative to the first path arrival time,  $T_l$ ;  $\Lambda$  is cluster arrival rate; and  $\lambda = \text{ray arrival rate}$ , i.e., the arrival rate of path within each cluster.

Therefore,  $\tau_{0l} = T_l$ . The distribution of cluster arrival time and the ray arrival time are given by

$$\begin{aligned} p(T_l | T_{l-1}) &= \Lambda \exp[-\Lambda(T_l - T_{l-1})], \quad l > 0 \\ p(\tau_{k,l} | \tau_{(k-1),l}) &= \lambda \exp[-\lambda(\tau_{k,l} - \tau_{(k-1),l})], \quad k > 0 \end{aligned} \quad (11)$$

The channel coefficients are defined as  $\alpha_{k,l} = p_{k,l} \beta_{k,l}$ ,  $\beta_{k,l}$  is obtained by this expression

$$20 \log_{10}(\beta_{k,l}) \propto \text{Normal}(\mu_{k,l}, \sigma^2) \quad (12)$$

$$\text{or } |\beta_{k,l}| = 10^{n/20}$$

where

$$n \propto \text{Normal}(\mu_l, \sigma^2) \quad (13)$$

$$E[\beta_{k,l}^2] = \Omega_0 e^{-T_l/\Gamma} e^{-\tau_{k,l}/\gamma}$$

$T_l$  is the excess delay of bin  $l$  and  $\Omega_0$  is the mean power of the first path of the first cluster, and  $p_{k,l}$  is  $\pm 1$ . Then  $\mu_l$  is given by

$$\mu_l = \frac{10 \ln(\Omega_0) - 10T_l/\Gamma - 10\tau_{k,l}/\gamma - \sigma^2 \ln(10)}{20} \quad (14)$$

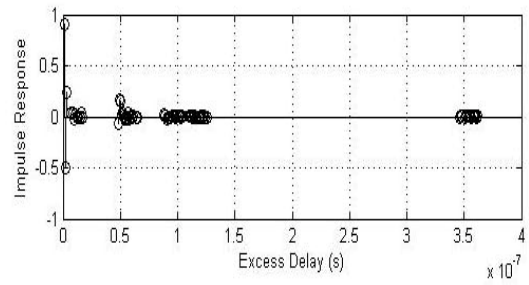

(a) LOS

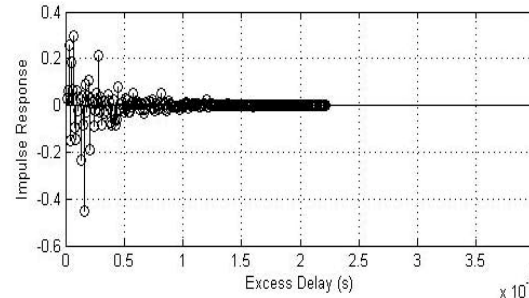

(b) NLOS

Fig. 4 The generated channel model

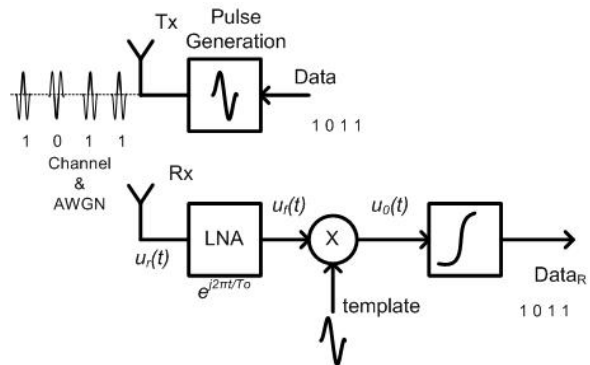

Fig. 5 UWB pulse communication

## V. SIMULATION METHOD

Fig. 5 shows the block diagram of the transmitter and receiver communication. Transmitter converts the data bits to UWB pulses and the pulse are transmitted through the antenna. There is a channel model between the transmitter and the receiver. At receiver, the pulses are received by antenna and LNA (Low Noise Amplifier) becomes  $u_r(t)$ . Finally, the pulses are detected using the template pulse. The Gaussian monocycle pulse expressed in (2) with  $T_c = 2.22 \times 10^{-1}$  ns is implemented. The PAM and PPM modulations are implemented using (3) and (7), respectively.

A channel is available between transceiver and receiver. An UWB channel model is derived from the modified Saleh-Valenzuela model suitable for home environment with both LOS and NLOS as described previously. There are 5 key parameters that define the model:  $\Lambda = \text{cluster arrival rate}$ ;  $\lambda =$

ray arrival rate, i.e., the arrival rate of path within each cluster;  $\Gamma$  = cluster decay factor;  $\gamma$  = ray decay factor; and  $\sigma$  = standard deviation of lognormal fading term (dB). All parameters are taken into account for channel modeling as formulated in (11)-(14).

This paper uses one channel model generated from S-V model using the parameters as shown in Table 1. The equation in (10)-(14) and Table 1 derived from and based on Intel measurements [12] are used to generate a channel model. The generated channel model is shown in Fig. 4.

TABLE 1 CHANNEL MODEL PARAMETERS.

MODEL PARAMETERS	LOS	NLOS
$\Lambda$ (1/nsec)	1/60	1/11
$\lambda$ (1/nsec)	1/0.5	1/0.35
$\Gamma$ (nsec)	16	16
$\gamma$ (nsec)	1.6	8.5
$\sigma$ (dB)	4.8	4.8

VI. SIMULATION RESULTS

The implementation is based on the block diagram as shown in Fig. 5 that shows the UWB pulse communication. The transceiver converts bits into UWB pulses, then the UWB pulses are reconverted the pulse back into bits by receiver. The comparison between the bits sent by transceiver and received by receiver gives BER value.

Gaussian monocycle pulse defined in (2) is implemented with  $T_c = 2.22 \times 10^{-1}$  ns and PAM and PPM modulations are applied as in (3) and (7). The channel is considered to analyze the bit rates of each pulse over the channel. The channel models, both LOS and NLOS using parameter in Table 1 are implemented as shown in Fig. 4.

Wireless communication systems that use frequency band between 3.1-10.6 GHz. GSM/UMTS uses 0.9-1.8GHz is rare, while WLAN uses 2.5 GHz. Only 802.11a system uses frequency band 5 GHz inside this UWB frequency standard. Therefore, some AWGN are included in the simulation.

$10^4$  bits is applied from the transceiver to receiver, and later being analyzed. The bits are sent in Mbps bit rates. The various bit rates and its BER can be seen in Fig. 7. Fig. 6 shows the result of the BER of PAM and PPM pulse modulation of IR\_UWB through the LOS and NLOS channel models. Fig. 6 shows that the influence of inter multipaths occurs in higher bit rates. The LOS channel model in Fig. 4 (a) has the last significant paths that cross a 10 dB threshold ( $NP_{10dB}$ ) at  $0.5 \times 10^{-7}$  sec and it has only 5 multipaths. It gives low BER until hundreds Mbps. Meanwhile, the NLOS channel has many multipaths that influence the pulses, so that it can not be sent in high bit rates. The NLOS channel model in Fig. 4 (b) has the last significant paths that cross a 10 dB threshold ( $NP_{10dB}$ ) at around  $1.0 \times 10^{-7}$  sec and it has around 33 multipaths, so that it is much thicker. The bit rates drops drastically in the NLOS channel model. Note that in order to draw the line in Fig. 7, the value of  $\log(10^{-6})$  is given instead of BER = 0, since log zero is infinity.

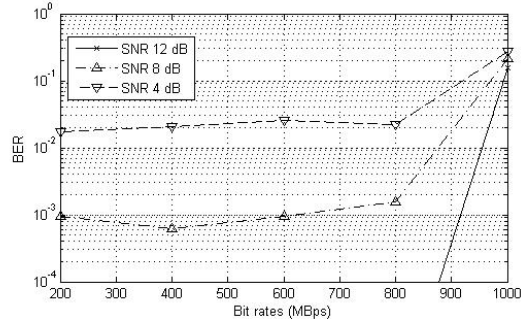

(a) PAM over LOS channel

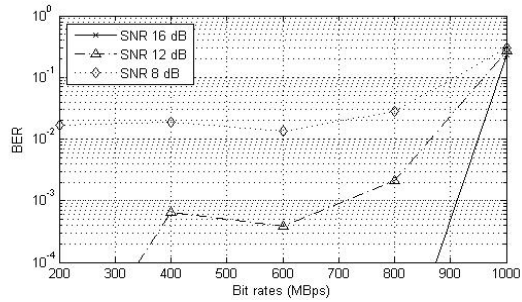

(b) PPM over LOS channel

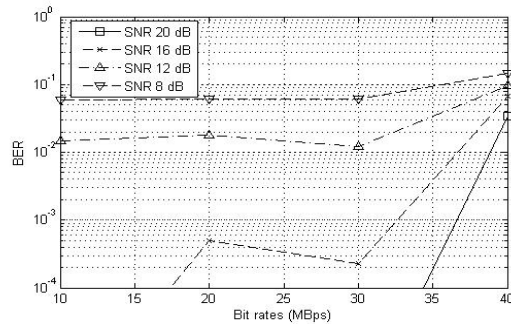

(c) PAM over NLOS channel

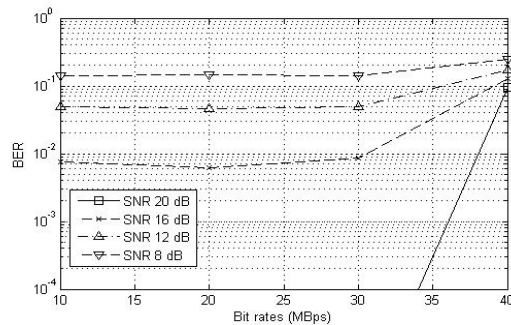

(d) PPM over NLOS channel

Fig. 6 BER of the UWB pulses through the LOS and NLOS channel models

Fig. 6 (a) shows data sent using PAM over the LOS channel model. The result shows that SNR 4 and 8 dB AWGN give

high BER. SNR 12 dB gives no error (or error lower than  $10^{-4}$ ) until 800 Mbps. BER increases drastically after 800 Mbps.

Fig. 6 (b) shows data sent using PPM over the LOS channel model. SNR 8 dB AWGN gives high BER. SNR 12 dB gives small error (in  $10^{-4}$  level) within 200 Mbps and error in  $10^{-3}$  level until 600 Mbps. BER increases after 600 Mbps. SNR 16 dB has no error (below  $10^{-4}$ ) until 800 Mbps, and the value of BER increases drastically afterwards.

Different from the LOS channel that has much higher bit rates, the NLOS channel gives lower bit rates for the communication. In Fig. 6 (c), data are sent using PAM over NLOS channel model. It has high BER until SNR 12 dB. SNR 16 dB has no error (or error lower than  $10^{-4}$ ) within 10 Mbps, gives BER in  $10^{-3}$  level for bit rates below 30 Mbps and BER increases drastically after 30 Mbps. SNR 20 dB has no error (or error lower than  $10^{-4}$ ) until 30 Mbps, but it has higher BER afterwards.

In Fig. 6 (d), data are sent using PPM over the NLOS channel model. It has high BER until SNR equals to 12 dB. SNR 16 dB gives BER in  $10^{-3}$  level for 30 Mbps and below and increases drastically afterwards. SNR 20 dB has no error (lower than  $10^{-4}$ ) until 30 Mbps. It has high BER for above 30 Mbps.

Comparing among the modulations, the result shows that for the same channel, PAM is more robust of AWGN, both in LOS and NLOS channels. From the results, UWB pulse communication is appropriate in LOS channel, i.e., has high bit rates (hundreds Mbps). Nevertheless, this communication can be used until several Mbps in NLOS channel model.

TABLE II ESTIMATE OF HIGHEST BIT RATES (HBR)

LOS	BIT RATES (MBPS)		
	SNR 28 dB	SNR 16 dB	SNR 12 dB
PAM	800	800	800
PPM	800	800	200
NLOS	BIT RATES (MBPS)		
	SNR 32 dB	SNR 20 dB	SNR 16 dB
PAM	30	30	30
PPM	30	30	-

Table 2 shows estimation of highest bit rates without error (or error less than  $10^{-4}$  level is tolerable). If the less BER is desired, then lower bit rate can be implemented. However, in high SNR environment, the high bit rate can still be implemented. It shows that PAM modulation over LOS channel gives the best performance. By looking at the UWB reference standard and compare to the others as shown in Table 3 [18], it seems that this communication model is preferable for the LOS channel.

Based on Fig. 6(a)-(d), some samples of bit rate are chosen to take a closer look at each modulation over LOS and NLOS channels. Based on Table 3, 400 Mbps is chosen for all modulations for the LOS channel. However, since the maximum bit rates for NLOS channel is only 30 Mbps, this rate is chosen.

There are  $10^4$  bits sent from the transceiver to receiver in Fig. 9. The figure shows the BER performance of the UWB

pulses through the LOS and NLOS channel models in the chosen bit rates. Fig 13 shows that PAM is more robust both in LOS and NLOS channels.

TABLE III COMPARISON OF UWB BIT RATE WITH OTHER STANDARDS.

SPEED (MBPS)	STANDARD
480	UWB, USB 2.0
200	UWB (4 m minimum)
110	UWB (10 m minimum)
90	Fast Ethernet
54	802.11a
20	802.11g
11	802.11b
10	Ethernet
1	Bluetooth

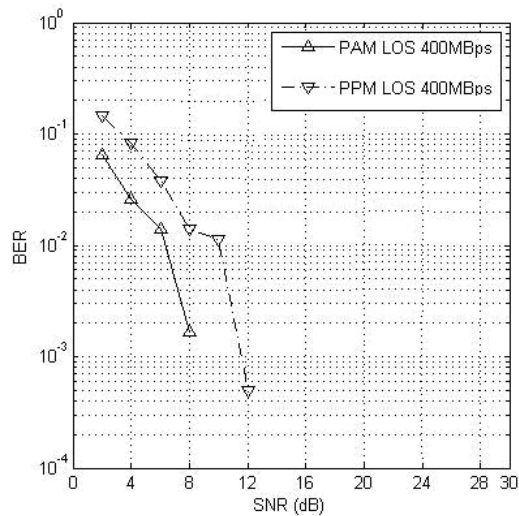

(a)

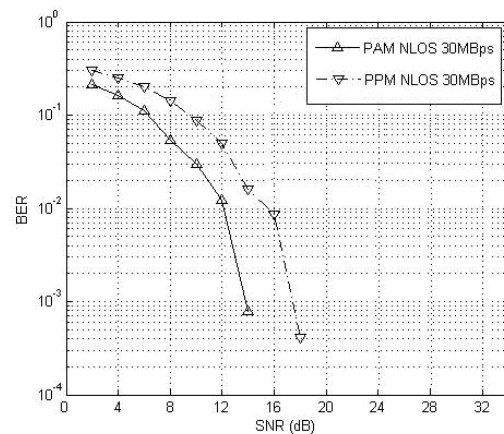

(b)

Fig. 7 BER performances over channels

When 400 Mbps is chosen for LOS channel model, it means that the pulse is sent in 2.5ns periodic time. PAM has BER in  $10^{-3}$  level for SNR 8 dB, and low BER (in  $10^{-4}$  level or lower) afterwards. Fig. 7 shows that data communication using PAM

that needs BER  $10^{-5}$  or less can be applied in SNR 12 dB or more.

PPM has BER in  $10^{-2}$  level within SNR 10 dB, and in  $10^{-4}$  level for SNR 10 dB. It can be estimated that using PPM, BER  $10^{-5}$  or less can be applied in SNR 14 dB or more.

When 30 Mbps is chosen for NLOS channel model, it means that the pulse is sent in 0.33 ns periodic time. PAM has BER in  $10^{-2}$  level for SNR 12 dB, BER in  $10^{-4}$  for SNR 14 dB, and low BER (lower than  $10^{-4}$  level) afterwards. Fig. 7 shows that data communication using PAM that needs BER  $10^{-5}$  or less can be applied in SNR 16 dB or more.

PPM has BER in  $10^{-2}$  level within SNR 14 dB, and in  $10^{-4}$  level for SNR 18 dB. It can be estimated that using PPM, BER  $10^{-5}$  or less can be applied in SNR 20 dB or more.

## VII. CONCLUSION

The BER analysis of the Impulse Radio Ultra Wide Band pulse communication over modified S-V channel model is presented. The pulse uses Gaussian monocycle pulse. The channel model uses a modified S-V model introduced by Intel. PAM and PPM are applied for modulation, and BER is measured over several bit rates. The result shows that all modulation are appropriate for both LOS and NLOS channel, but PAM gives better performance in bit rates and SNR. Moreover, as standard of speed has been given for UWB, the communication is appropriate with high bit rates in LOS channel.

## ACKNOWLEDGMENT

The authors would like to thank Prof. Yoshikazu Miyayaga (Hokkaido University) for the constructive comments and insights that help to improve this paper.

## REFERENCES

- [1] [1] FCC 04-48 "First Report and Order in the Matter of Revision of Part 15 of the Commission's Rules Regarding Ultra-wideband Transmission Systems." Feb.14, 2002.
- [2] [2] R. A. Scholtz, "Multiple access with time-hopping impulse modulation," Proc. MILCOM '93, vol. 2, pp. 447-450, 1993.
- [3] [3] M. Z. Win, R.A. Scholtz, "Ultra-wide bandwidth time-hopping spread-spectrum impulse radio for wireless multiple-access communications", IEEE Trans. Comm., vol. 48, no. 4, pp. 679-691, April 2000.
- [4] [4] I. Oppermann, M. Hamalainen, and J. Iinatti, "UWB Theory and Applications", John Wiley & Sons, West Sussex, 2004.
- [5] [5] S.-C. Lin and T.-D. Chiueh, "Performance analysis of impulse radio under timing jitter using M-ary bipolar pulse waveform and position modulation", in IEEE Conf. Ultra Wideband Systems and Technologies, Dig. Papers, Reston, VA, Nov. 16-19, 2003, pp. 121-125.
- [6] [6] D. J. Clabaugh, M. A. Temple, R. A. Raines, and C. M. Canadeo, "UWB multiple access performance using time hopped pulse position modulation with biorthogonal signaling", in IEEE Conf. Ultra Wideband Systems and Technologies, Dig. Papers, Reston, VA, Nov. 16-19, 2003, pp. 330-333.
- [7] [7] W. Xu, R. Yao, Z. Guo, W. Zhu, and Z. Zhou, "A power efficient M-ary orthogonal pulse polarity modulation for TH-UWB system using modified OVFSF codes", in Proc. IEEE Global Telecommunications Conf. (GLOBECOM), San Francisco, CA, Dec. 1-5, 2003, vol. 1, pp. 436-440.
- [8] [8] L. Ge, G. Yue, and S. Affes, "On the BER Performance of Pulse-Position Modulation UWB Radio in Multipath Channels", Proc. IEEE Conference on Ultra Wideband Systems and Technologies, pp. 231-234, May 2002.
- [9] [9] G. Yue, L. Ge, and S. Li, "Performance of UWB time-hopping spread-spectrum impulse radio in multipath environments", Proc. IEEE Semiannual Vehicular Technology Conference (VTC '03), vol. 3, pp. 1644-1648, April, 2003.
- [10] [10] J. Karedal, S. Wyne, P. Almers, F. Tufvesson and A.F. Molisch, "Statistical Analysis of the UWB Channel in an Industrial Environment", Proc. IEEE Vehicular Technology Conference (VTC 2004), pp. 81-85, Sept. 2004.
- [11] [11] D. Cassioli, M. Win and A. Molisch, "The Ultra-Wide Bandwidth Indoor Channel: From Statistical Model to Simulations", IEEE Journal on Selected Areas in Communications, Vol. 20, No. 6, pp. 1247-1257, 2002.
- [12] [12] J. R. Foerster, Q. Li, "UWB Channel Modeling Contribution from Intel", IEEE P802.15 Working Group for Wireless Personal Area Networks (WPANs), June 2002, [http://www.ieee802.org/15/pub/2002/Jul02/02279r0P802-15\\_SG3a-Channel-Model-Cont-Intel.doc](http://www.ieee802.org/15/pub/2002/Jul02/02279r0P802-15_SG3a-Channel-Model-Cont-Intel.doc)
- [13] [13] X. Chen, and S. Kiaei, "Monocycle shapes for ultra wideband system", Proc. IEEE International Symposium on Circuits and Systems, vol. 1, pp. 597-600, May 2002.
- [14] [14] A. M. Saleh, R. A. Valenzuela, "A statistical model for indoor multipath propagation", IEEE Journal on Selected Areas in Communications, SAC-5 no.2, pp.128-137, 1987.
- [15] [15] A.F. Molisch, J.R. Foerster, M. Pendergrass, "Channel models for Ultra wideband personal area networks", IEEE Wireless Communications, vol. 10, Issue 6, pp.14-21, 2003.
- [16] [16] G. Breed, "A Summary of FCC Rules for Ultra Wideband Communications,"2005,<http://www.highfrequencyelectronics.com/Archives/Jan05/>
- [17] [17] S. Hongsan, P. Orlik, A.M. Haimovich, L. J. Jr. Cimini, and Z. Jinyun, "On the Spectral and Power Requirements for Ultra-Wideband Transmission", Proc. IEEE on Communications, vol. 1, pp. 738 - 742, May 2003.
- [18] [18] M. Ghavami, L. B. Michael, R. Kohno, "Ultra Wideband Signals and Systems in Communication Engineering", John Wiley & Sons, West Sussex, 2004.