

Bandwidth Enhancement in CPW Fed Compact Rectangular Patch Antenna

Kirti Vyas, P. K. Singhal

Abstract—This paper presents a novel CPW fed patch antenna supporting a wide band from 2.7 GHz – 6.5 GHz. The antenna is compact with size $32 \times 30 \times 1.6\text{mm}^3$, built over FR4-epoxy substrate ($\epsilon_r=4.4$). Bandwidth enhancement has been achieved by using the concept of modified ground structure (MGS). For this purpose structural design has been optimized by parametric simulations in CST MWS. The proposed antenna can perform well in variety of wireless communication services including 5.15 GHz- 5.35 GHz and 5.725 GHz- 5.825 GHz WLAN IEEE 802.11 g/a, 5.2/ 5.5/ 5.8 GHz Wi-Fi, 3.5/5.5 GHz WiMax applications and 3.7 - 4.2 GHz C band satellite communications bands. The measured experimental results show that bandwidth ($S_{11} < -10$ dB) of antenna is 3.8 GHz. The performance of antenna is studied in terms of reflection coefficient, radiation characteristics, current distribution and gain.

Keywords—Broad band antenna, Compact, CPW fed, WLAN, Wi-Fi, Wi-Max, CST MWS.

I. INTRODUCTION

DUe to increasing demand of mobile wireless communication systems there has been tremendous growth in the research potential for advanced compact planar antennas which can fulfill the demand of broadband characteristics. However these antennas suffer the limitation of narrow bandwidth which can be mitigated with use of suitable feeding technology such as coplanar waveguide feed which gives a uniplanar structure to the printed antennas. The planar monopole antennas with coplanar waveguide (CPW) feeding mechanism has gained researchers attention due to its advantages over microstrip type feed lines, such as low dispersion, low radiation leakage, the ability to effectively control the characteristic impedance, and the ease of integration with active devices. For this purpose, antennas with broadband characteristics are in strong demand [1-12]. These broadband antennas should have the potential to serve for various applications such as WLAN IEEE 802.11 g/a (5.15 GHz- 5.35 GHz and 5.725 GHz- 5.825 GHz), 5.2/ 5.5/ 5.8 GHz Wi-Fi applications, WiMax 3.5/5.5 and C band satellite communications 3.7 - 4.2 GHz band, HIPERLAN/2 specified in two bands: from 5.15 to 5.35 GHz and from 5.470 to 5.725 GHz and lower Ultra wide band (UWB) applications with the band of 3.1-6.5 GHz.

Kirti Vyas is with the ACEIT, Kukas, Jaipur, India She is research scholar in ECE Dept. of Bhagwant University, Ajmer, Rajasthan ,India(phone: 9929164029; e-mail: kirtivyas19@gmail.com).

P.K. Singhal is with MITS Gwalior, India. He is professor in Department of ECE (e-mail: pks_65@yahoo.com).

The purpose of this work is to design a compact broadband antenna using MGS technique which can cover various wireless applications which are listed above and which is easy to implement.

II. PROPOSED CPW FED ANTENNA

Fig. 1 shows proposed CPW fed patch antenna with modified ground planes. Two bevels are cut in the lower portion of the rectangular patch to enhance the bandwidth. The width of the central strip of CPW antennas is of 3 mm, and the gap between the central strip and ground planes is 0.5mm. Two symmetric stepped ground planes are placed on both side of the central strip. The optimized design parameters obtained for the proposed patch antenna are $L = 32\text{mm}$, $W = 30\text{mm}$, $g = 0.5\text{mm}$, $W_f = 3\text{mm}$, $L_{g1} = 9.5\text{mm}$, $L_{g2} = 6.5\text{mm}$, $L_{g3} = 3.9\text{mm}$, $LS1 = LS2 = Ws1 = Ws2 = 5\text{mm}$. Used dielectric substrate (FR4 epoxy) has relative dielectric constant ϵ_r of 4.4, loss tangent of 0.02 and thickness of 1.6mm.

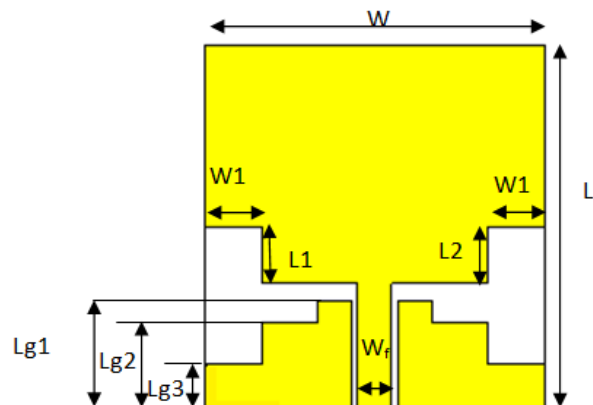

Fig. 1 The geometric design of proposed antenna

The antenna has a single layer metallic structure on one side of the substrate (top) where as other side (bottom) is without any metallization. Fig. 2 shows the fabricated cost effective patch antenna.

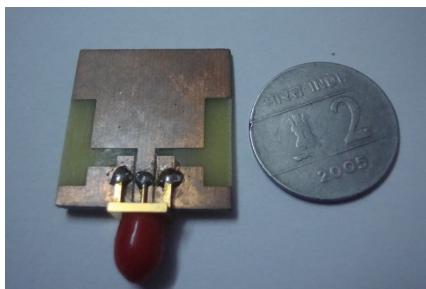

Fig. 2 The fabricated prototype of antenna

III. RESULTS AND DISCUSSIONS

Designed antenna is simulated using CST MWS. The CPW central metal strip width, length and the gap (g) of distance between the strip and the coplanar ground plane are fixed at 3mm, 11 m and 0.5mm, respectively, in order to achieve 50 Ω CPW feed line. The radiating element of designed antenna has two square shaded bevels of dimension ‘L1 X W1’ and ‘L1 X W2’ of 5 X 5mm² each to enhance impedance bandwidth. The fabricated antenna is characterized with Rohde and Schwarz vector network analyzer ZVA40 for reflection coefficient versus frequency, which has been plotted with the simulated results in Fig. 3.

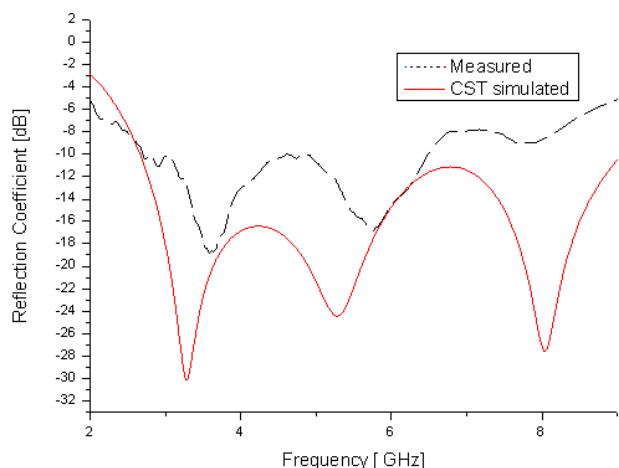

Fig. 3 Reflection Coefficient of proposed antenna

The simulated results of reflection coefficient versus frequency are in good agreement in the lower cut off frequency and with. The CPW fed antenna has attained huge impedance bandwidth with modified symmetrical ground planes. This proposed antenna achieves a significant bandwidth of 3.8 GHz ranging from 2.7- 6.5 GHz with respect to the central frequency at 4.5 GHz which makes this antenna a good candidate for wireless applications.

We find a slight variation between the simulated and experimentally measured results at higher frequencies. This can be due to the dielectric losses introduced at high frequencies or uncertainty of the purchased dielectric constant of the substrate. In order to achieve a good impedance matching we need to optimize the dimensions of the bevels

‘L1 X W1’ and ‘L1 X W2’. Hence we start analysis with varying Length of the bevel ‘Ls1’ keeping all parameters same. Fig. 4 shows the effect of length ‘Ls1’ on the proposed antenna. As per the simulated results; most desired wideband is obtained at Ls1 = 5mm. For ‘Ls1’ values lesser than 5mm, the antenna is not able to radiate properly for frequencies around 6.5 GHz and gives poor impedance matching. The parametric analysis is performed on the width of the bevel ‘Ws1’ in Fig. 6. It can be seen from Fig. 5 that decreasing the bevel width below 5mm makes antenna nonresonating from 6- 7 GHz. However increasing the WS1 value above 5mm reduces antenna bandwidth, so WS1= 5mm is the optimized dimension for this design.

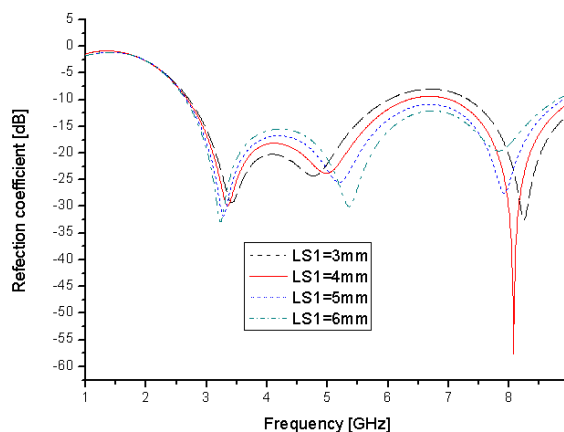

Fig. 4 Effect of Variation of Length Ls1

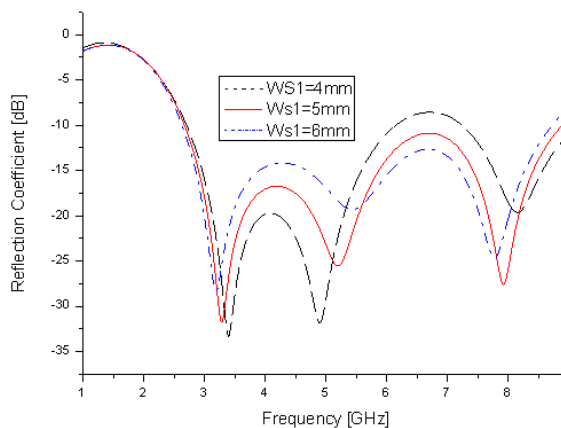

Fig. 5 Effect of Variation Ws1

Fig. 6 shows the parametric analysis results for various ‘Lg1’. It is observed that the maximum bandwidth is obtained at Lg1=9.5, while increasing or decreasing the value of Lg1 reduces impedance bandwidth.

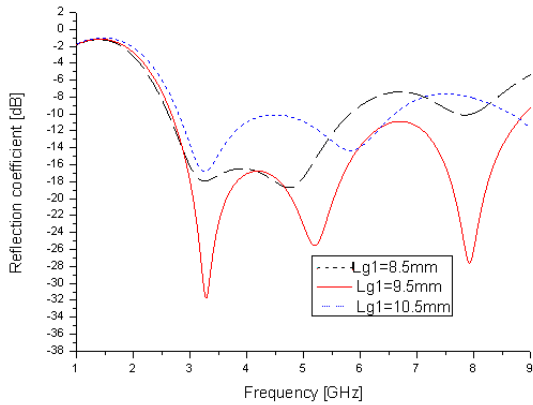

Fig. 6 Simulated result of proposed antenna with various 'Lg1'

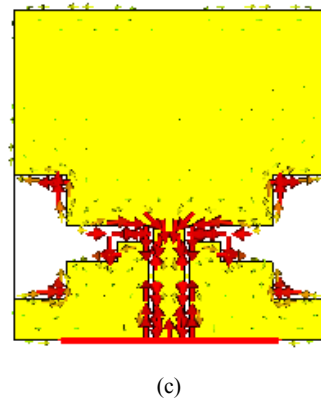

Fig. 7 Simulated current distributions of the proposed antenna at various frequencies

Figs. 7 (a)-(c) show the current distribution in the antenna at 3GHz, 5 GHz and 8 GHz respectively. The current distribution is shown in form of vector plot showing surface current in form of arrows along the antenna structure. The area with more density of arrows shows the presence of large magnitude current values which can also be seen with the color scale given in left of the figure.

Here it can be seen that in low frequency ranges at 3 GHz (see Fig. 7 (a)) the maximum current distribution is around the central metallic conductor of the CPW feed and the lower region of the radiating patch and as the frequency increase the current components are also seen in the stepped ground planes and the bevels in the patch so as to improve the impedance matching which explains the role of stepped ground plane in improving the performance of the antenna in terms of improved impedance matching. Fig. 8 shows the radiation patterns of the proposed antenna at selective frequencies of 3, 5, 6 GHz respectively.

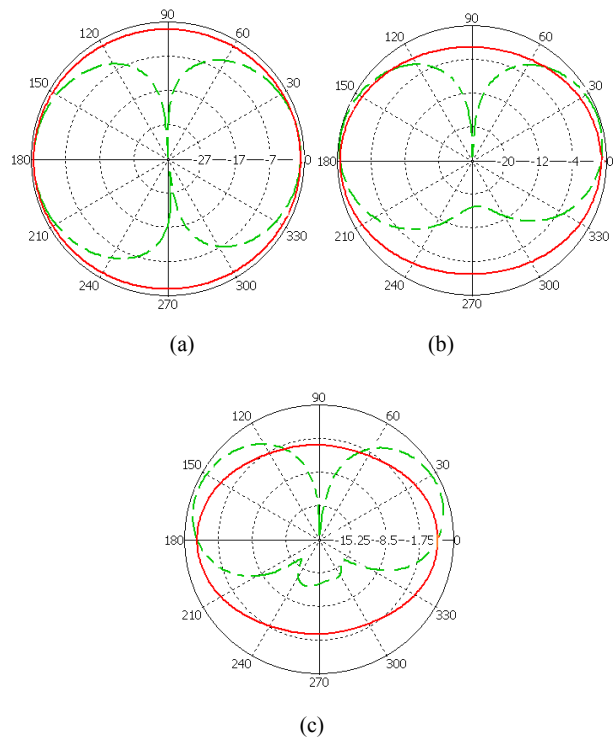
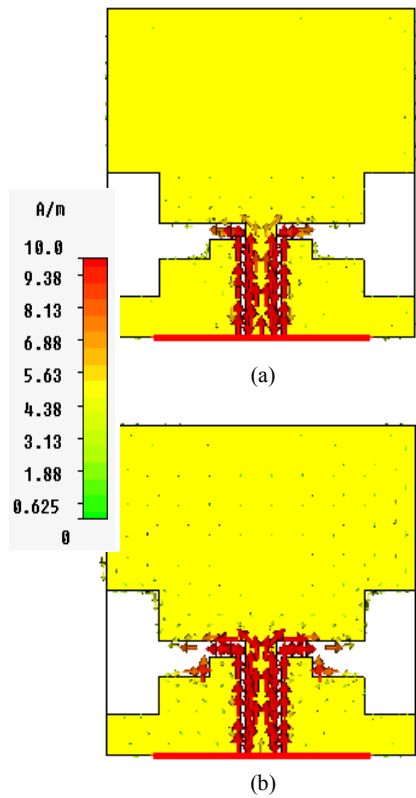

Fig. 8 Simulated radiation patterns of the proposed antenna (xz plane, omnidirectional-H plane, Bidirectional-E plane) at three different frequencies.

It is seen that the radiation patterns of the antenna with MGS in H-plane (x - z plane) are nearly omnidirectional in entire band of operation and radiation patterns in the E- plane (y - z plane) resembles figure of eight and are bidirectional. The obtained monopoles like radiation pattern are suitable for the practical wireless applications. The radiation patterns are stable.

Fig. 9 shows the simulated peak gain of the proposed antenna for the frequency band 2.7-8.3 GHz. Maximum gain of the antenna with MGS is 5 dBi at 8 GHz. It can be noticed that antenna has stable radiation patterns (see figure 8) and achieves improved gain values at higher frequencies (see Fig. 9). The gain of the proposed antenna is effectively high for practical wireless applications.

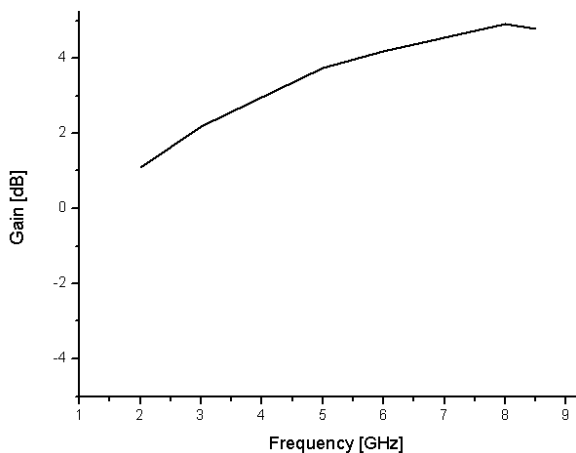

Fig. 9 Peak gain of the proposed antenna

IV. CONCLUSION

CPW fed patch antenna has been designed, fabricated, parametrically analyzed and characterized to obtain broad band characteristics with modified ground structure. The wideband has been achieved by optimizing the dimensions of the ground planes and by etching two symmetric square shaped bevels in radiating patch. The measured impedance bandwidth ($VSWR < 2$) of proposed antenna is 3.8 GHz. The antenna offers satisfactory gain across the operating band. The antenna geometry is simple and can be easily implemented.

ACKNOWLEDGMENT

The authors are grateful to Dr. A. K. Sinha, CEERI (CSIR), Pilani (Rajasthan), Dr. A. K. Sharma Prof. ECE Deptt. GIT Jaipur and Dr. Deepak Bhatnagar, Rajasthan University, Jaipur, India, for providing the facilities for this research work.

REFERENCES

[1] Bhoje, A. U., C. L. Holloway, M. Picket-May, and R. Hall, "Wide-band slot antennas with CPW feed lines: Hybrid and log-periodic designs," *IEEE Trans. Antennas Propag.*, Vol. 52, No. 10, pp.2545-2554, October 2004.

- [2] Lin, X. C. and C.-C. Yu, "A dual-band CPW-fed inductive slot-monopole hybrid antenna," *IEEE Trans. Antennas Propag.*, Vol. 56, No. 1, pp. 282-285, January 2008.
- [3] Chen, J.-S., "Dual-frequency annular-ring slot antennas fed by CPW feed and microstrip line feed," *IEEE Trans. Antennas Propag.*, Vol. 53, No. 1, pp.569-573, January 2005.
- [4] Jiao, J. J., G. Zhao, F. S. Zhang, H.-W. Yuan, and Y.-C. Jiao, "A broadband CPW-fed T-shape slot antenna," *Progress In Electromagnetics Research*, Vol. 76, pp.237-242, 2007.
- [5] Dastranj, A. and H. Abiri, "Bandwidth enhancement of printed E-shaped slot antennas fed by CPW and microstrip line," *IEEE Trans. Antennas Propag.*, Vol. 58, No. 4, Apr. 2010.
- [6] J. H. Yoon "Fabrication and Measurement of Rectangular Ring with Open Ended CPW Fed Monopole Antenna for 2.5/5.2-GHz WLAN Operation", *Microw. Opt. Tech. Lett.*, Vol. 48, No. 8, pp. 1480-1483, August 2006.
- [7] Chiou, J.-Y, J.-Y. Sze, and K.-L. Wong, "A broad-band CPW-fed strip-loaded square slot antenna," *IEEE Trans. Antennas Propag.*, Vol. 51, No. 4, 719-721, April 2003.
- [8] Chen, H.-D., "Broadband CPW-fed square slot antenna with a widened tuning stub," *IEEE Trans. Antennas Propag.*, Vol. 51, No. 8, 1982-1986, August 2003.
- [9] T. Shanmuganatham, K. Balamanikandan, and S. Raghavan "CPW-Fed Slot Antenna for Wideband Applications", *Hindawi Publishing Corporation, International Journal of Antennas and Propagation*, Volume 2008, Article ID 379247, doi:10.1155/2008/379247.
- [10] M. Miao, B. L. Ooi, P. S. Kooi, "Broad band CPW fed wide slot antenna," *Microwave optical technol. Letter*, Vol 25, no. 3, pp 206-211, May 2002.
- [11] Chang-Ju Wu, I-Fong Chen, and Chia-Mei Peng, "A Dual Polarization Bow-tie Slot Antenna for Broadband Communications," *Progress In Electromagnetics Research Symposium Proceedings*, Marrakesh, Morocco, Mar. 20-23, 2011.
- [12] Kirti Vyas, Garima Sanyal, Arun Kumar Sharma and Pramod Kumar Singhal, "Gain Enhancement Over a Wideband in CPW-Fed Compact Circular Patch Antenna," *International Journal of Microwave and Wireless Technologies*, doi: 10.1017/S1759078713001037.

Kirti Vyas was born in Jaipur (India) on 19th Nov 1979. She received a M.Tech degree in Electronics and communication from the Malvia National Institute of Technology, Jaipur, Rajasthan, India. She is a M.Tech coordinator at the Arya College of Engineering and I.T., Kukas, Jaipur, Rajasthan, India. She is pursuing her Ph.D. from ECE Deptt. ,Bhagwant University, Ajmer, Rajasthan, India. Her main research interests are design and optimization of microstrip patch antennas. She has about more than 30 publications to his credit at the national and International level.