

# Application of Pulse Doubling in Star-Connected Autotransformer Based 12-Pulse AC-DC Converter for Power Quality Improvement

Rohollah. Abdollahi, and Alireza. Jalilian

**Abstract**—This paper presents a pulse doubling technique in a 12-pulse ac-dc converter which supplies direct torque controlled motor drives (DTCIMD's) in order to have better power quality conditions at the point of common coupling. The proposed technique increases the number of rectification pulses without significant changes in the installations and yields in harmonic reduction in both ac and dc sides. The 12-pulse rectified output voltage is accomplished via two paralleled six-pulse ac-dc converters each of them consisting of three-phase diode bridge rectifier. An autotransformer is designed to supply the rectifiers. The design procedure of magnetics is in a way such that makes it suitable for retrofit applications where a six-pulse diode bridge rectifier is being utilized. Independent operation of paralleled diode-bridge rectifiers, i.e. dc-ripple re-injection methodology, requires a Zero Sequence Blocking Transformer (ZSBT). Finally, a tapped interphase reactor is connected at the output of ZSBT to double the pulse numbers of output voltage up to 24 pulses. The aforementioned structure improves power quality criteria at ac mains and makes them consistent with the IEEE-519 standard requirements for varying loads. Furthermore, near unity power factor is obtained for a wide range of DTCIMD operation. A comparison is made between 6-pulse, 12-pulse, and proposed converters from view point of power quality indices. Results show that input current total harmonic distortion (THD) is less than 5% for the proposed topology at various loads.

**Keywords**—AC-DC converter, star-connected autotransformer, power quality, 24 pulse rectifier, Pulse Doubling, direct torque controlled induction motor drive (DTCIMD).

## I. INTRODUCTION

RECENT advances in solid state conversion technology has led to the proliferation of variable frequency induction motor drives (VFIMD's) that are used in several applications such as air conditioning, blowers, fans, pumps for waste water treatment plants, textile mills, rolling mills etc [1]. The most practical technique in VFIMD's is direct torque controlled strategy in that it offers better performance rather than the other control techniques. direct torque controlled technique is implemented in voltage source inverter which is mostly fed

from six-pulse diode bridge rectifier, Insulated gate bipolar transistors (IGBT's) are employed as the VSI switches. The most important drawback of the six-pulse diode-bridge rectifier is its poor power factor injection of current harmonics into ac mains. The circulation of current harmonics into the source impedance yields in harmonic polluted voltages at the point of common coupling (PCC) and consequently resulting in undesired supply voltage conditions for costumers in the vicinity. The value of current harmonic components which are injected into the grid by nonlinear loads such as DTCIMDs should be confined within the standard limitations. The most prominent standards in this field are IEEE standard 519 [2] and the International Electrotechnical Commission (IEC) 61000-3-2 [3].

According to considerable growth of Static Power Converters (SPC's) that are the major sources of harmonic distortion and as a result their power quality problems, researchers have focused their attention on harmonic eliminating solutions. Passive and active filters are compensating devices which are utilized in power grids to enhance power quality. However, they introduce some drawbacks. Passive filter installations are bulky and require extra area. Furthermore, they cause additional losses and the variations in resonance frequency influences their operation and consequently making their design complex. Likewise, active filters implementation is complicated and costly. Besides, their ratings should be analogous to load rating.

The aforementioned problems and harmonic pollution could be nearly resolved using multi-pulse AC-DC converters. Basically, Harmonic cancellation in multi-pulse converters is accomplished via two or more paralleled bridge rectifiers in which their supplying voltages are phase shifted according to the desired output voltage pulse number. Various schematics of 12-pulse AC-DC converters have been proposed by researchers so far [4-8]. Although, these topologies do not meet the IEEE standard requirements for permissible harmonic distortion. Obviously, more paralleled bridge rectifiers will result in higher pulse numbers and, consequently, better power quality conditions. On the contrary, the cost and complexity of the whole system will increase significantly. Reduced cost and complexity of AC-DC converters beside the improved power quality indices can be achieved by DC ripple re-injection method [9-16].

R. Abdollahi is Msc student at the Department of Electrical Engineering, Iran University of Science and Technology, Tehran, Iran (e-mail: rohollah.abdollahi@yahoo.com).

A. Jalilian is with the Department of Electrical Engineering, Centre of Excellence for Power System Automation and Operation, Iran University of Science and Technology, Tehran, Iran (e-mail: jalilian@just.ac.ir).

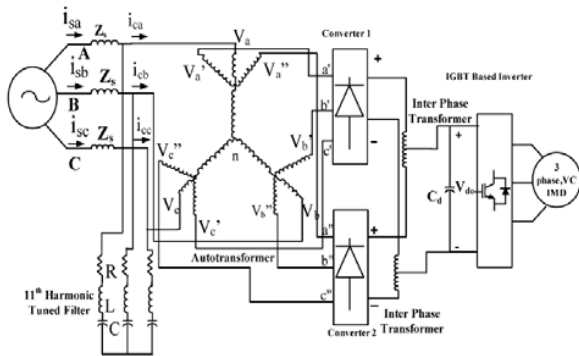

Fig. 1 star-connected autotransformer configuration for 12-pulse ac-dc conversion [12]

The zigzag-connected autotransformer-based 24-pulse topology [16] was designed for VCIMD's loads having a THD variation of 5.017% to 6.38% from full-load to light-load (20% of full-load) respectively. The dc link voltage in this topology is higher than that of a 6-pulse diode bridge rectifier, thus making the scheme non-applicable for retrofit applications.

A star-connected autotransformer-based 12-pulse AC-DC converter is reported in [12], which is not within the IEEE-519 limits. To improve the power quality, a passive shunt filter has been designed in accordance with IEEE Standard 1531-2003 [24]. along with the designed passive filters has THD variation of 4.42% to 8.84% from full-load to light-load (20% of full-load), but even with this configuration, the THD of ac mains current at light load is 8.84%, which is also not within IEEE Standard 519 limits.

In this paper, a 24-pulse ac-dc converter is extracted from this star-connected autotransformer-based 12-pulse ac-dc converter through adding a pulse doubling circuit in the DC link. The proposed design method will be suitable even when the transformer output voltages vary while keeping its 12-pulse operation. In the proposed structure, two three-leg diode-bridge rectifiers are paralleled via a Zero Sequence Blocking Transformer (ZSBT) and fed from an autotransformer. Hence, a 12-pulse output voltage is obtained. In order to double the number of pulses up to 24, a tapped Inter-Phase Reactor (IPR) with two additional diodes are included in the rectifiers output. This pulse multiplication works on the basis of ripple re-injection method, where the power of the circulating ripple frequency is fed back to the dc system via an IPR [9].

In other words, the removal of harmonics in 12-pulse converter is accomplished via the dc voltage ripple which is the frequency source for the derivation of adequate voltage and current waveforms. Ratings of IPR are small versus output apparent power. The number of turns in each IPR taps is such that the operation of diodes produces a near sinusoidal waveform in the ac line currents. Detailed design tips of the tapped IPR and totally the whole structure of 24-pulse ac-dc converter are described in this paper and the proposed converter is modeled and simulated in MATLAB to study its behavior and specifically to analyze the power quality indices at ac mains.

Furthermore, a 12-pulse ac-dc converter consisting of a

star-connected autotransformer, two six-pulse diode bridge rectifiers paralleled through two IPTs, and with a DTCIMD load Fig. 1 is also designed and simulated to compare its operation with the proposed 24-pulse ac-dc converter. Simulation results of six-pulse, 12-pulse and proposed 24-pulse ac-dc converters feeding a DTCIMD load are scheduled and various quality criteria such as THD of ac mains current, power factor, displacement factor, distortion factor, and THD of the supply voltage at PCC are compared.

## II. 24-PULSE AC-DC CONVERTER

As mentioned previously, the pulse-doubling technique requires a zero-sequence-blocking transformer (ZSBT) and a diode-tapped inter-phase reactor to multiple the number of a pulses up to 24.

It is known that a 12-pulse rectified voltage can be made with two paralleled six-pulse three-phase (three-leg) diode-bridge rectifiers. The phase shift between two supplying voltages should be 30 degrees. Similarly, in order to implement a 12-pulse ac-dc converter through paralleling two bridge rectifiers, i.e. two 6-pulse rectifiers, two sets of three-phase voltages with a phase difference of 120 degrees between the voltages of each group and 30 degrees between the same voltages of the two groups are required. Accordingly, each bridge rectifier consists of three common-anode and three common-cathode diodes (two three-leg rectifiers). A star-connected autotransformer is designed to produce the three phase voltages which are shown in Fig. 3. Autotransformer connections and its phasor diagram which shows the angular displacement of voltages are illustrated in Fig. 3. An overall schematic of the proposed 24-pulse ac-dc converter is shown in Fig. 4.

### A. Design of Proposed Autotransformer for 12-Pulse AC-DC Converter

The aforementioned two voltage sets are called as  $(V_{a1}, V_{a2}, V_{a3})$  and  $(V_{b1}, V_{b2}, V_{b3})$  that are fed to rectifiers I and II, respectively. The same voltages of the two groups, i.e.  $V_{ai}$  and  $V_{bi}$ , are phase displaced of 30 degrees.  $V_{a1}$  and  $V_{b1}$  has a phase shift of +15 and -15 degrees from the input voltage of phase A, respectively. According to phasor diagram, the three-phase voltages are made from ac main phase and line voltages with fractions of the primary winding turns which are expressed with the following relationships.

Consider three-phase voltages of primary windings as follows:

$$V_A = V_s \angle 0^\circ, V_B = V_s \angle -120^\circ, V_C = V_s \angle 120^\circ. \quad (1)$$

Where, three-phase voltages are:

$$V_{a1} = V_s \angle 15^\circ, V_{b1} = V_s \angle -105^\circ, V_{c1} = V_s \angle 135^\circ \quad (2)$$

$$V_{a2} = V_s \angle -15^\circ, V_{b2} = V_s \angle -135^\circ, V_{c2} = V_s \angle 105^\circ \quad (3)$$

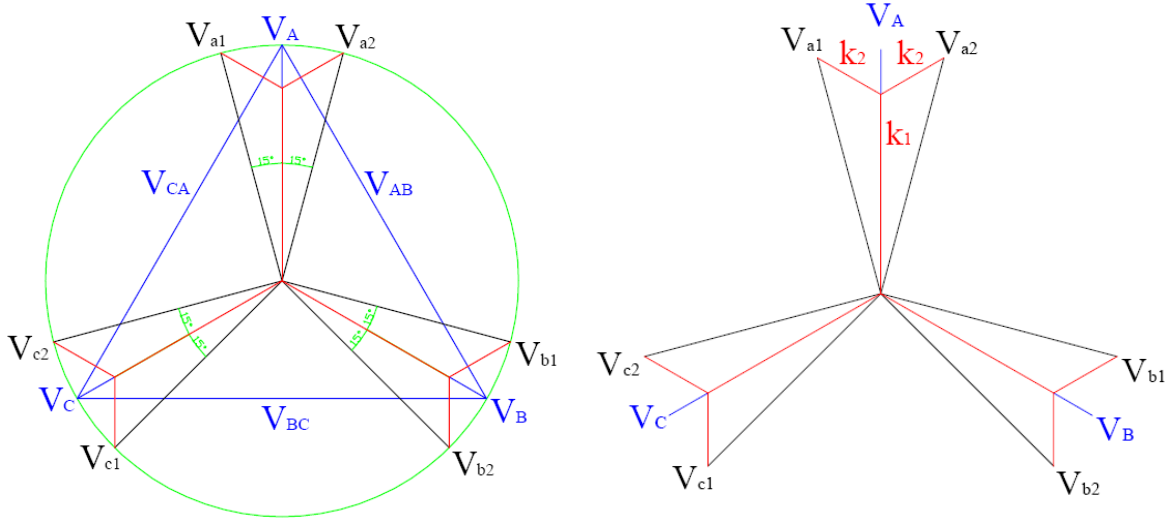

Fig. 2 star connection of proposed autotransformer for 12-pulse converter and its phasor representation

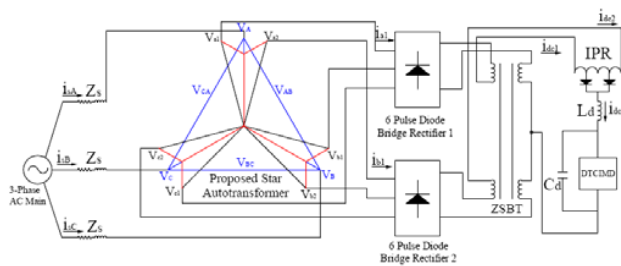

Fig. 3 star-connected autotransformer configuration for 24-pulse ac-dc conversion

Input voltages for converter I are:

$$\begin{aligned} V_{a1} &= K_1 V_A - K_2 V_B \\ V_{b1} &= K_1 V_B - K_2 V_C \\ V_{c1} &= K_1 V_C - K_2 V_A \end{aligned} \quad (4)$$

Input voltages for converter II are:

$$\begin{aligned} V_{a2} &= K_1 V_A - K_2 V_C \\ V_{b2} &= K_1 V_B - K_2 V_A \\ V_{c2} &= K_1 V_C - K_2 V_B \end{aligned} \quad (5)$$

$$V_{AB} = \sqrt{3}V_A \angle 30^\circ, V_{BC} = \sqrt{3}V_B \angle 30^\circ, V_{CA} = \sqrt{3}V_C \angle 30^\circ. \quad (6)$$

Constants  $K_1$ - $K_2$  are calculated using (2)-(6) to obtain the required windings turn numbers to have the desired phase shift for the two voltage sets:  
 $K_1 = 0.816, K_2 = 0.298.$  (7)

### B. Design of Autotransformer for Retrofit Applications

The value of output voltage in multipulse rectifiers boosts relative to the output voltage of a six-pulse converter making the multipulse rectifier inappropriate for retrofit applications. For instance, with the autotransformer arrangement of the proposed 24-pulse converter, the rectified output voltage is 3% higher than that of six-pulse rectifier.

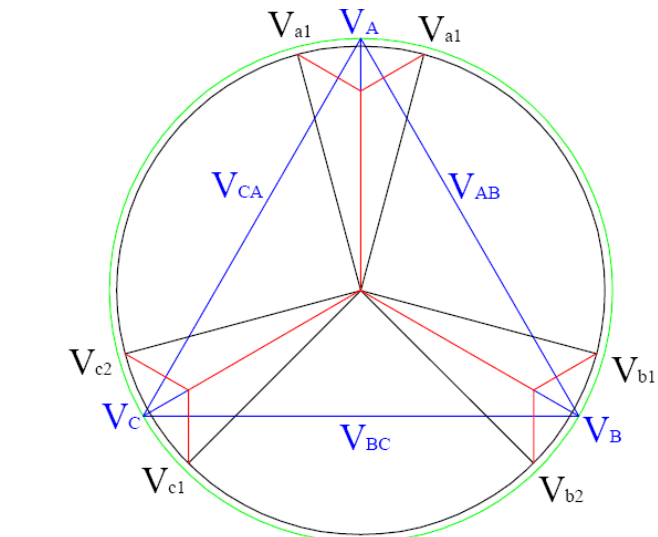

Fig. 4 Phasor diagram of voltages in the proposed autotransformer connection along with modifications for retrofit arrangement

For retrofit applications, the above design procedure is modified so that the dc-link voltage becomes equal to that of six-pulse rectifier.

This will be accomplished via modifications in the tapping positions on the windings as shown in Fig. 4. It should be noted that with this approach, the desired phase shift is still unchanged. Similar to section II part A, the following equations can be derived as:

$$|V_s| = 0.97 |V_A| \quad (8)$$

Accordingly, the values of constants  $K_1$  and  $K_2$  are changed for retrofit applications as:

$$K_1 = 0.79445, K_2 = 0.29079. \quad (9)$$

The values of  $K_1$  and  $K_2$  establish the essential turn numbers of the autotransformer windings to have the required

output voltages and phase shifts. The kilovoltampere rating of the autotransformer is calculated as [4]:

$$\text{kVA} = 0.5 \sum V_{\text{winding}} I_{\text{winding}} \quad (10)$$

Where,  $V_{\text{winding}}$  is the voltage across each autotransformer winding and  $I_{\text{winding}}$  indicates the full load current of the winding. Apparent power ratings of the tapped-interphase reactor and zero-sequence-blocking transformer (ZSBT) are also calculated in a same way.

### C. Interphase Transformer

The theory of pulse multiplication has been presented in [9] where a tapped inter-phase reactor along with two additional diodes are used to double the number of pulses in the supply line current resulting in current harmonic reduction. Afterwards, tapped interphase reactor was used in [17]-[22] to double the number of pulses in 12-pulse ac-dc converters. Furthermore, this type of multiplier was also served in paralleled thyristor bridge rectifiers [23]. Likewise, we used a tapped interphase reactor (IPR) to extract a 24-pulse current from two paralleled 6-pulse rectifiers. The IPR and tapped diodes are shown in Fig. 5. For the pulse multiplication process, it is necessary to ensure that the average output voltages of bridges are equal and phase shifted of 30 degrees. As two 6-pulse rectifiers are paralleled, the voltage across the interphase transformer,  $V_m$ , has a frequency 6 times that of the supply system. Therefore, size, weight and volume of the transformer reduce relative to rectifiers with a less pulse number.  $V_m$  is an alternating voltage with both positive and negative half cycles. Hence,  $D_1$  conducts when the  $V_m$  is positive and, on the other hand,  $D_2$  conducts when  $V_m$  is negative. The MMF equivalence between the windings when  $D_1$  is on yields:

$$i_{\text{dc}1} N_A = i_{\text{dc}2} N_B \quad (11)$$

Where,  $N_A$  and  $N_B$  are number of turns as shown for IPR. We also have:

$$i_{\text{dc}1} + i_{\text{dc}2} = i_{\text{dc}} \quad (12)$$

Using (13) and (14), output current of the two rectifiers are calculated as follows:

$$\begin{aligned} i_{\text{dc}1} &= (0.5 + K_t) i_{\text{dc}} \\ i_{\text{dc}2} &= (0.5 - K_t) i_{\text{dc}} \end{aligned} \quad (13)$$

In the above equation,  $N_O = N_A + N_B$  and  $K_t = (N_B - 0.5N_O) / N_O$ . The same relations can be written when  $V_m$  is in its negative half cycle. Therefore, according to MMF equation, the magnitude of output currents changes which results in pulse multiplication in the supply current. In [11], it is proved that  $K_t$  should be equal to 0.2457 to eliminate the harmonic currents up to the 21st order which can be applied in this application too.

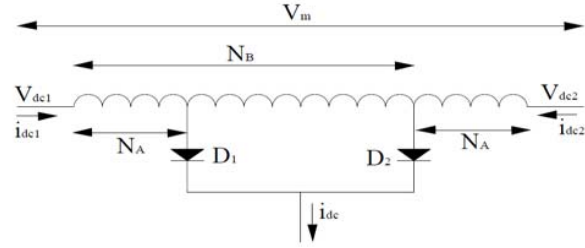

Fig. 5 Tapped Inter-phase Transformer circuit

### D. Zero Sequence Blocking Transformer

In parallel-rectifier configurations, the two converters cannot be directly paralleled. Because, the output voltages are phase-shifted thereby unwanted conduction sequence of diodes is probable. Therefore, a zero-sequence-blocking transformer is required to ensure the independent operation of two paralleled rectifiers. In the proposed 24-pulse converter, the voltage frequency of ZSBT is three times that of the supply system and it shows high impedance zero sequence (and its multiples) current harmonics and prevents them to flow. Furthermore, high ripple frequency of the supply voltage in ZSBT makes it small and light.

## III. MATLAB-BASED SIMULATION

Fig. 6 shows the implemented ac-dc converter with DTCIMD in MATLAB software using SIMULINK and power system block set (PSB) toolboxes. In this model, a three-phase 460 V and 60 Hz network is utilized as the supply for the 24-pulse converter. The designed autotransformer is modeled via three multi-winding transformers. Multi-winding transformer block is also used to model ZSBT and IPT. At the converter output, a series inductance (L) and a parallel capacitor (C) as the dc link are connected to IGBT-based Voltage Source Inverter (VSI). VSI drives a squirrel cage induction motor employing direct torque controlled strategy. The simulated motor is 50 hp (37.3 kW), 4-pole, and Y-connected. Detailed data of motor are listed in Appendix A. Simulation results are depicted in Figs. 8-22. Power quality parameters are also listed in Table I for 6-pulse, 12-pulse, and 24-pulse ac-dc converters.

## IV. RESULTS AND DISCUSSION

Table I lists the power quality indices obtained from the simulation results of the 6-pulse, 12-pulse, and 24-pulse converters. Matlab block diagram of 24-pulse ac-dc converter system simulation, as shown in Fig. 7. Fig. 8 depicts two groups of three-phase voltage waveforms with a phase shift of 30 degrees between the same voltages of each group. The rectifiers output voltages (two groups of 6-pulse voltage) with a phase difference of 30 degrees are shown in Fig. 9. The voltage across the interphase transformer (shown in Fig. 10) has a frequency equal to 6 times that of the supply which results in a significant reduction in volume and cost of magnetics.

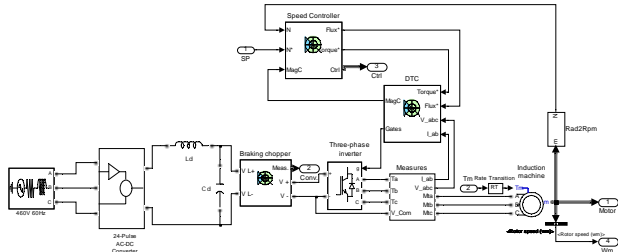

Fig. 6 Matlab model of 24-pulse ac-dc converter fed DTCIMD

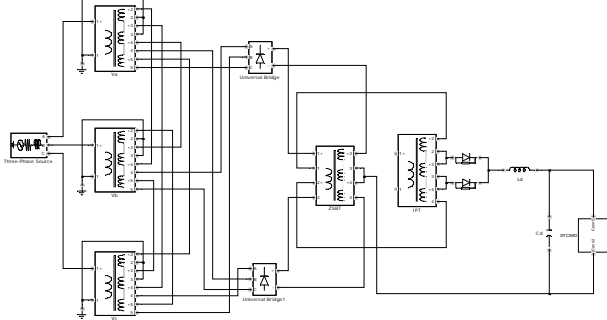

Fig. 7 Matlab block diagram of 24-pulse ac-dc converter system simulation

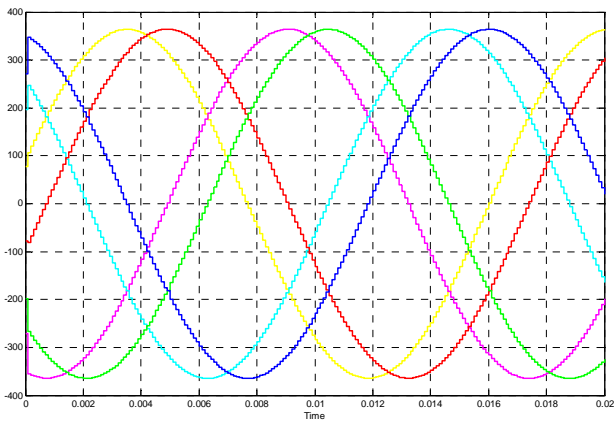

Fig. 8 autotransformer output voltage (two groups of 3-phase voltage)

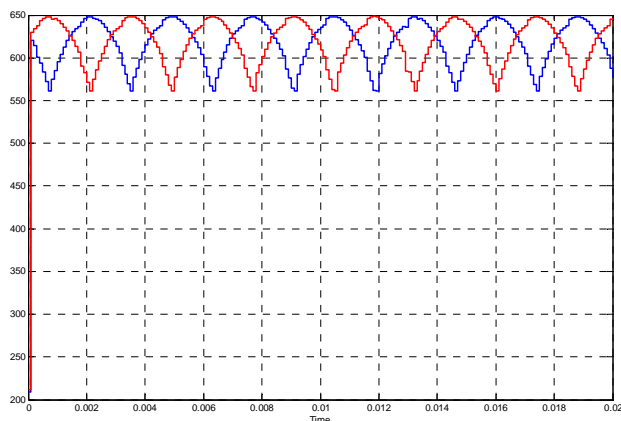

Fig. 9 Rectifiers output voltage (two groups of 6-pulse voltage)

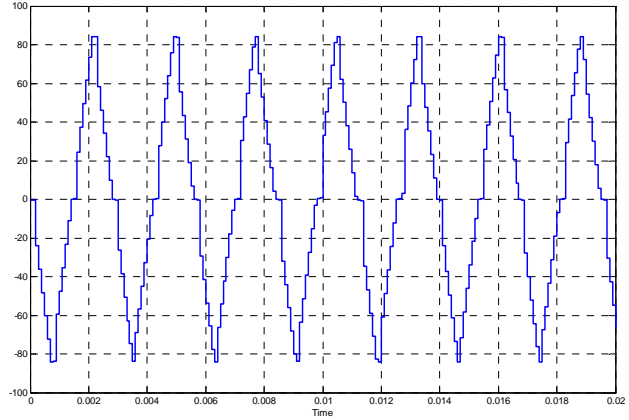

Fig. 10 Voltage waveform across the double-tap IPT

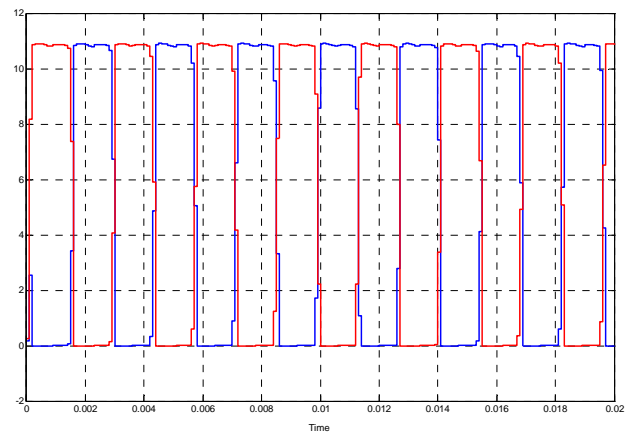

Fig. 11 Diodes  $D_1$  and  $D_2$  current waveforms

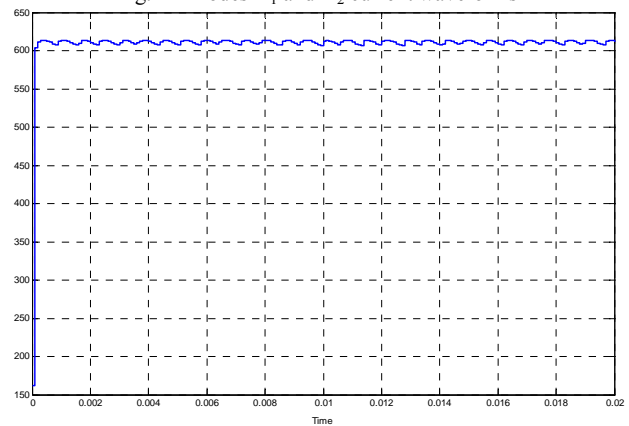

Fig. 12 24-pulse ac-dc converter output voltage

The current waveforms of pulse doubling diodes are shown in Fig. 11. Diode  $D_1$  conducts when the voltage across the IPT is positive and, conversely,  $D_2$  is on when the voltage across the IPT is in its negative half-cycle. The magneto motive force (MMF) equivalence of the IPT windings are formulated in equation (13) when  $D_1$  is on. This conduction sequence of the diodes is the basis of the pulse doubling technique.

TABLE I  
COMPARISON OF SIMULATED POWER QUALITY PARAMETERS OF THE DTCIMD FED FROM DIFFERENT AC-DC CONVERTERS

Sr. No.	Topology	% THD of $V_{ac}$	AC Mains Current $I_{SA}$ (A)		% THD of $I_{SA}$ at		Distortion Factor, DF		Displacement Factor, DPF		Power Factor, PF		DC Voltage (V)	
			Light Load	Full Load	Light Load	Full Load	Light Load	Full Load	Light Load	Full Load	Light Load	Full Load	Light Load	Full Load
1	6-pulse	5.63	10.25	52.56	52.80	28.52	0.884	0.959	0.985	0.988	0.872	0.948	616.6	607.6
2	12-pulse	3.27	10.56	53.46	13.32	7.52	0.991	0.997	0.992	0.981	0.983	0.978	619.2	605.9
3	24-pulse	3.04	10.49	52.32	5.93	4.57	0.998	0.998	0.997	0.997	0.995	0.995	612.8	607.4

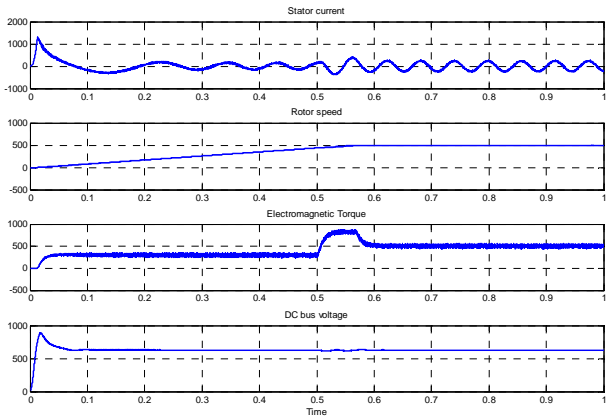

Fig. 13 Waveforms depicting dynamic response of 24-pulse diode rectifier fed DTCIMD with load perturbation (source current  $i_{SA}$ , speed  $\omega_r$ , developed electromagnetic torque  $T_e$ , and dc-link voltage  $V_{dc}$ )

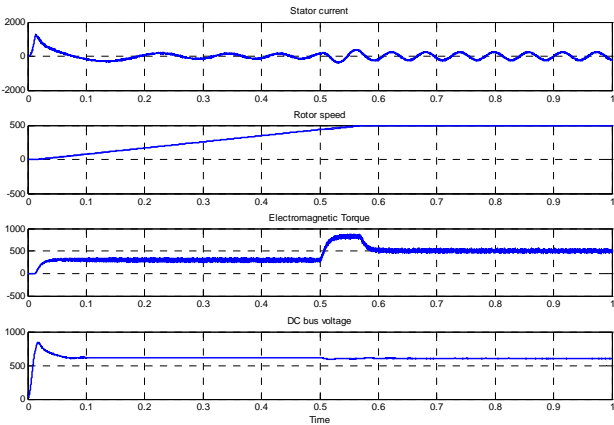

Fig. 14 Waveforms depicting dynamic response of six-pulse diode rectifier fed DTCIMD with load perturbation

The 24-pulse converter output voltage (shown in Fig. 12) is almost smooth and free of ripples and its average value is 607.4 volts which is approximately equal to the DC link voltage of a six-pulse rectifier (607.6 volts). This makes the 24-pulse converter suitable for retrofit applications.

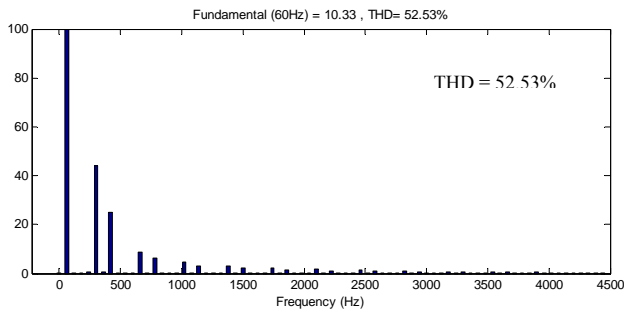
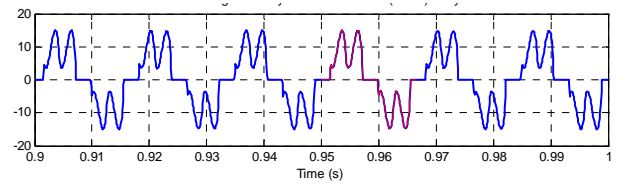

Fig. 15 Input current waveform of six-pulse ac-dc converter at light load and its harmonic spectrum

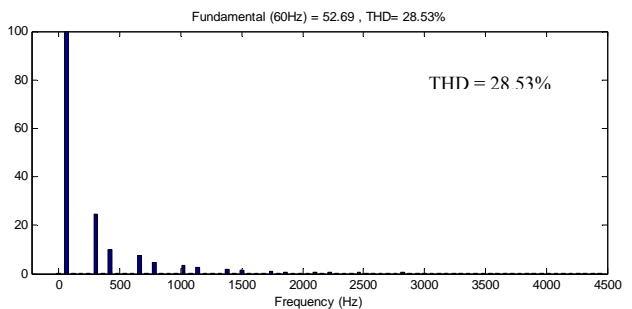
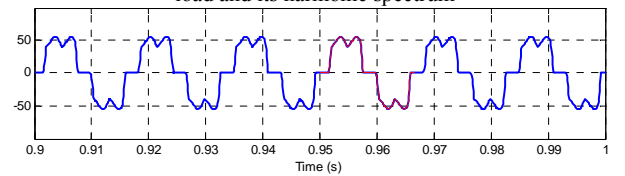

Fig. 16 Input current waveform of six-pulse ac-dc converter at full load and its harmonic spectrum

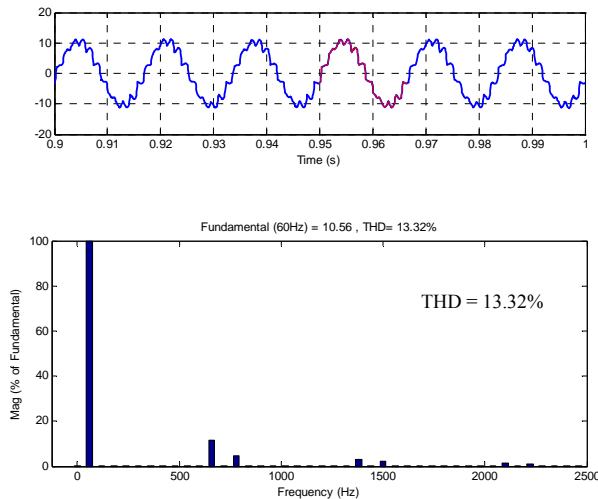

Fig. 17 Input current waveform of 12-pulse ac-dc converter at light load and its harmonic spectrum

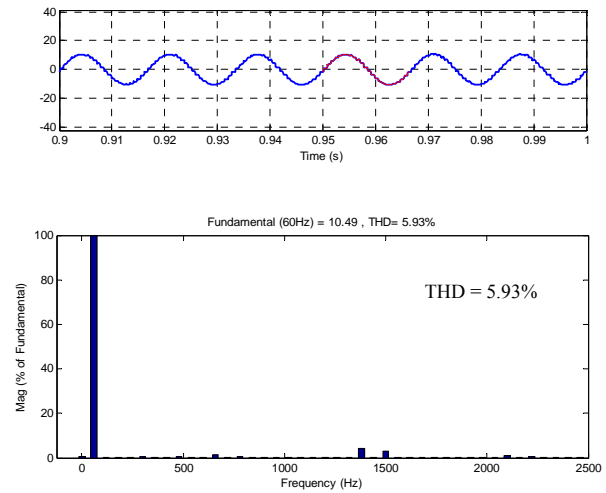

Fig. 19 Input current waveform of 24-pulse ac-dc converter at light load and its harmonic spectrum

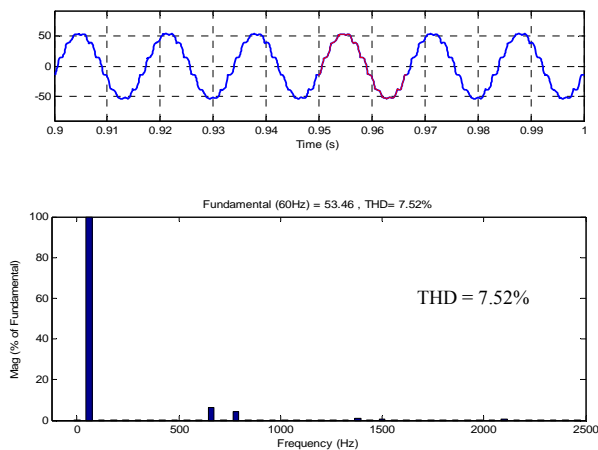

Fig. 18 Input current waveform of 12-pulse ac-dc converter at full load and its harmonic spectrum

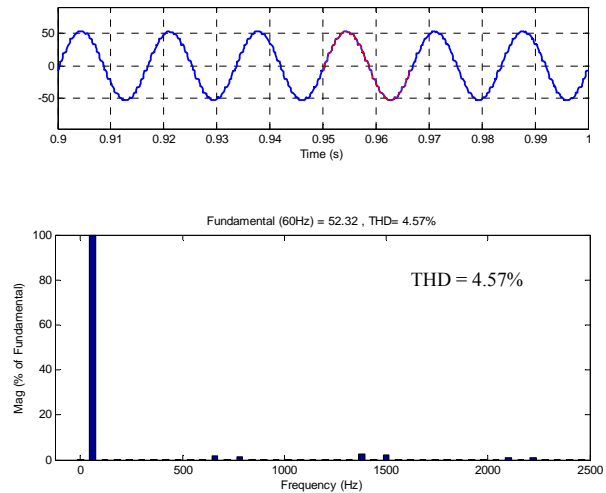

Fig. 20 Input current waveform of 24-pulse ac-dc converter at full load and its harmonic spectrum

Different output and input characteristics of the proposed 24-pulse converter feeding DTCIMD such as supply current, rotor speed, electromagnetic torque, and DC link voltage are shown in Fig. 13. These waveforms can be compared with their equivalent parameters of a six-pulse fed DTCIMD that are shown in Fig. 14. The dynamic characteristics of the two converters can be used to compare their dynamic response through conditions such as starting or load variations.

Input current waveforms and its harmonic spectrum of the 6-pulse, 12-pulse, and 24-pulse converters extracted and shown in Figs. 15-20, respectively to check their consistency with the limitations of the IEEE standard 519. These harmonic spectra are obtained when induction motor operates under light load (20% of full load) and full load conditions. Hence, input current THD of this converter will be relatively a large amount and is equal to 28.52% and 52.80% for full load and light load conditions that are not within the standard margins.

The THD of ac mains current of 12-pulse ac-dc converter at full load is 7.52%, which deteriorates to 13.32% at light load, which is also not within IEEE Standard 519 limits. On the other hand, as shown in Figs. 19-20, 24-pulse converter has an acceptable current THD (5.93% for light load and 4.57% for full load conditions). In this configuration, low order harmonics up to 21st are eliminated in the supply current.

In general, the largely improved performance of the 24-pulse converter makes the power quality indices such as THD of supply current and voltage (THDi and THDv), displacement power factor (DPF), distortion factor (DF), and power factor (PF) satisfactory for different loading conditions. The aforementioned criteria are listed in Table I for the three types of converters.

TABLE II  
COMPARISON OF POWER QUALITY INDICES OF PROPOSED 24-PULSE AC-DC CONVERTER

Load (%)	THD (%)		CF of $I_s$	DF	DPF	TPF	RF (%)	$V_{dc}$ (V)
	$I_s$	$V_s$						
20	5.93	1.14	1.412	0.9982	0.9971	0.9953	0.007	612.8
40	5.48	1.63	1.412	0.9983	0.9976	0.9959	0.006	611.1
60	5.11	2.21	1.412	0.9985	0.9974	0.9959	0.008	609.9
80	4.81	2.70	1.413	0.9985	0.9971	0.9958	0.004	608.6
100	4.57	3.04	1.413	0.9986	0.9968	0.9954	0.010	607.4

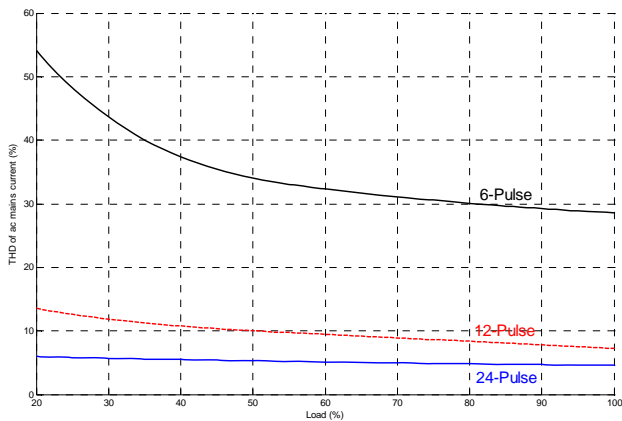

Fig. 21 Variation of THD with load on DTCIMD in 6-pulse, 12-pulse and 24-pulse ac-dc converter

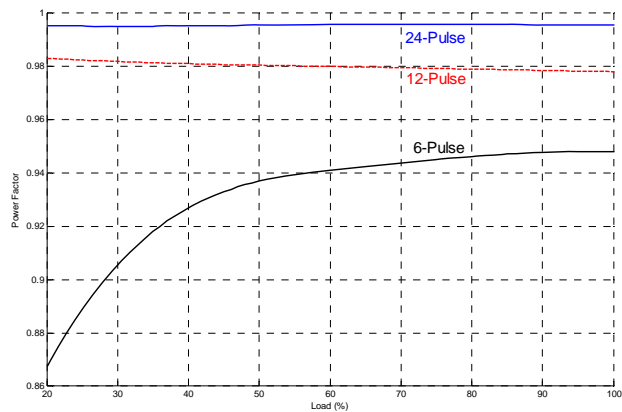

Fig. 22 Variation of power factor with load on DTCIMD in 6-pulse, 12-pulse and 24-pulse ac-dc converter

Input current THD and power factor variations are also shown in Figs. 21 and 22 respectively, for 6-pulse, 12-pulse, and 24-pulse ac-dc converters. Results show that the input current corresponding to the proposed configuration has an almost unity power factor. Furthermore, in the worst case (light loads) the current THD has reached below 5% for the proposed topology.

Different power quality indices of the proposed topology under different loading conditions are shown in Table II. Results show that even under load variations, the 24-pulse converter has an improved performance and the current THD is always less than 5% for all loading conditions.

## V. CONCLUSION

In this paper a star-connected autotransformer was designed and modeled to make a 24-pulse ac-dc converter with DTCIMD load. Afterwards, the proposed design procedure was modified for retrofit applications. A zero-sequence-blocking transformer was added to ensure the independent operation of paralleled rectifiers and a tapped inter-phase reactor was used to double the number of pulses in the ac mains currents. The increased number of pulses results in the frequency increase of the supply voltages of ZSBT and IPR, thereby, decreasing the size and volume of the transformers. Simulation results prove that, for the proposed topology, input current distortion factor is in a good agreement with IEEE 519 requirements. Current THD is less than 5% for varying loads. It was also observed that the input power factor is close to unity resulting in reduced input current for DTCIMD load.

## APPENDIX

### A. Motor and Controller Specifications

Three-phase squirrel cage induction motor—50 hp (37.3 kW), three phase, four pole, Y-connected, 460 V, 60 Hz.  $R_s = 0.0148 \Omega$ ;  $R_r = 0.0092 \Omega$ ;  $X_{ls} = 1.14 \Omega$ ;  $X_{lr} = 1.14 \Omega$ ,  $X_{Lm} = 3.94 \Omega$ ,  $J = 3.1 \text{ Kg} \cdot \text{m}^2$ .

Controller parameters: PI controller  $K_p = 300$ ;  $K_i = 2000$ .

DC link parameters:  $L_d = 2 \text{ mH}$ ;  $C_d = 3200 \mu\text{F}$ .

Source impedance:  $Z_s = j0.1884 \Omega$  ( $\approx 3\%$ ).

## REFERENCES

- [1] B. K. Bose, Modern Power Electronics and AC Drives. Singapore: Pearson Education, 1998.
- [2] IEEE Standard 519-1992, IEEE Recommended Practices and Requirements for Harmonic Control in Electrical Power Systems. New York: IEEE Inc., 1992.
- [3] IEC Standard 61000-3-2:2004, Limits for harmonic current emissions, International Electromechanical Commission. Geneva, 2004.
- [4] D. A. Paice, Power Electronic Converter Harmonics: Multipulse Methods for Clean Power. New York: IEEE Press, 1996.
- [5] Bin Wu, High-Power Converters and AC Drives, IEEE Press, Wiley-Interscience, 2006.
- [6] S. Choi, P. N. Enjeti, and I. J. Pitel, "Polyphase transformer arrangements with reduced kVA capacities for harmonic current reduction in rectifier type utility interface", IEEE Trans. on Power Electronics, Vol. 11, No. 5, pp. 680–689, September 1996.
- [7] P. W. Hammond, "Autotransformer", U.S. Patent No. 5619407, April 8, 1997.
- [8] B. Singh, G. Bhuvaneswari, and V. Garg, "Harmonic mitigation using 12-pulse ac-dc converter in vector-controlled induction motor drives," IEEE Trans. Power Delivery, vol. 21, no. 3, pp. 1483–1492, Jul. 2006.
- [9] S. Choi, B. S. Lee, and P. N. Enjeti, "New 24-pulse diode rectifier systems for utility interface of high power ac motor drives," IEEE Trans. Ind. Appl., vol. 33, no. 2, pp. 531–541, Mar.–Apr. 1997.



- [10] B. Singh, G. Bhuvaneswari, V. Garg, and S. Gairola, "Pulse multiplication in ac-dc converters for harmonic mitigation in vector controlled induction motor drives," *IEEE Trans. Energy Conv.*, vol. 21, no. 2, pp.342–352, Jun. 2006.
- [11] B. Singh, V. Garg, and G. Bhuvaneswari, "Polygon-Connected Autotransformer-Based 24-Pulse AC-DC Converter for Vector-Controlled Induction-Motor Drives" *IEEE Transactions on Industrial Electronics*, vol. 55, no. 1, pp.197–208, January 2008.
- [12] B. Singh, G. Bhuvaneswari, and V. Garg, "Harmonic Mitigation in AC-DC Converters for Vector Controlled Induction Motor Drives" *IEEE Transactions on Energy Conversion*, Vol. 22, no. 3, pp. 637 - 646, Sept. 2007.
- [13] B. Singh, G. Bhuvaneswari, and V. Garg, "Harmonic Mitigation in AC-DC Converters for Vector Controlled Induction Motor Drives" in *Proc. IEEE Conf. Power Electron. Drives Syst. PEDS*, 2005.
- [14] [10] B. Singh, G. Bhuvaneswari, V. Garg, "Power-quality improvements in vector-controlled induction motor drive employing pulse multiplication in AC-DC converters", *IEEE Trans. on Power Delivery*, vol. 21 no. 3, pp. 1578 – 1586, July 2006.
- [15] B. Singh, G. Bhuvaneswari, V. Garg, "24-Pulse AC-DC Converter for Power Quality Improvement in Vector Controlled Induction Motor Drives", *Electric Power Systems and Components*, vol. 34, no. 10, pp. 1077 - 1098, October 2006.
- [16] B. Singh, and S. Gairola, "Pulse Multiplication in Autotransformer Based AC-DC Converters using a Zigzag Connection," *Journal of Power Electronics*, Vol. 7, No. 3, July 2007.
- [17] S. Miyairi, S. Iida, K. Nakata, and S. Masukawa, "New method for reducing harmonics involved in input and output of rectifier with interphase transformer," *IEEE Trans. Ind. Appl.*, vol. 22, no. 5, pp. 790–797, Oct.–Nov. 1986.
- [18] M. E. Villablanca and J. A. Arrilaga, "Pulse multiplication in parallel converters by multi tap control of interphase reactor," in *Proc. Inst. Elect. Eng.—B*, vol. 139, no. 1, Jan. 1992, pp. 13–20.
- [19] S. Choi, B. S. Lee, and P. N. Enjeti, "New 24-pulse diode rectifier systems for utility interface of high power ac motor drives," *IEEE Trans. Ind. Appl.*, vol. 33, no. 2, pp. 531–541, Mar.–Apr. 1997.
- [20] S. Miyairi, S. Iida, K. Nakata, and S. Masubawa, "New method for reducing harmonics involved in input and output of rectifier with interphase transformer," *IEEE Trans. Ind. Appl.*, vol. IA-22, no. 5, pp. 790–797, Sep./Oct. 1986.
- [21] P. Qijun, M. Weiming, L. Dezhi, Z. Zhihua, and M. Jin, "A New Critical Formula and Mathematical Model of Double-Tap Interphase Reactor in a Six Phase Tap-Changer Diode Rectifier" *IEEE Transactions on Industrial Electronics*, vol. 54, no. 1, pp.479–485, February 2007.
- [22] F. Meng, S. Yang, W. Yang, and X. Jin, "Comments and Further Results on A New Critical Formula and Mathematical Model of Double Tap Interphase Reactor in a Six-Phase Tap-Changer Diode Rectifier" *IEEE Transactions on Industrial Electronics*, vol. 57, no. 3, pp.950–953, March 2010.
- [23] J. Arrilaga and M. Villablanca, "24-pulse HVDC conversion," *Proc. Inst. Elect. Eng.*, vol. 138, no. 1, pp. 57–64, Jan. 1991
- [24] *IEEE Guide for Application and Specification of Harmonic Filters*, IEEE Std. 1573, 2003.