

# A Study on Application of Elastic Theory for Computing Flexural Stresses in Preflex Beam

Nasiri Ahmadullah, Shimozato Tetsuhiro, Masayuki Tai

**Abstract**—This paper presents the step-by-step procedure for using Elastic Theory to calculate the internal stresses in composite bridge girders prestressed by the Preflexing Technology, called Prebeam in Japan and Preflex beam worldwide. Elastic Theory approaches preflex beams the same way as it does the conventional composite girders. Since preflex beam undergoes different stages of construction, calculations are made using different sectional and material properties. Stresses are calculated in every stage using the properties of the specific section. Stress accumulation gives the available stress in a section of interest. Concrete presence in the section implies prestress loss due to creep and shrinkage, however; more work is required to be done in this field. In addition to the graphical presentation of this application, this paper further discusses important notes of graphical comparison between the results of an experimental-only research carried out on a preflex beam, with the results of simulation based on the elastic theory approach, for an identical beam using Finite Element Modeling (FEM) by the author.

**Keywords**—Composite girder, elastic theory, preflex beam, prestressing.

## I. INTRODUCTION

**S**TRESS is the basic phenomena an engineer needs to know for approaching analysis and design of a structural member. The elastic theory has been widely used to deal with computations of flexural stresses in structural members. Challenges for engineers in terms of limitations to be met in the design procedure are changing over the developing periods. Stiffness, deflection, and depth of the members are the most challenging requirements to be met. To gain the full benefit of the strength characteristics, and meanwhile, keep deformations within the acceptable limits, a long span beam of high strength material must possess greater stiffness [2]. The simplest solution is to use a beam of greater depth; however, this would reduce clearance [2]. Composite beams are considered as an efficient option to meet the requirements to a wide extent. In many instances, the most desirable beam is that which gives the lowest depth to span ratio possible [2].

Following the development of prestressing technology by the Austrian engineer Eald Hoyer [3], the preflex technology, developed by Belgian engineers [4], helped professionals of the era in utilization of the structural members to the highest in terms of strength. Elastic theory, as it applies to beams of two

materials of different elastic properties, may be used to predict stresses which will occur in a preflexed beam when the preflexing load is applied and when it is removed [1]. It also may be used to predict changes in stresses which occur in preflexed beams when they are subjected to working loads [1]. The elastic theory predicts flexural stresses in composite sections prestressed by the preflexing method of prestressing using the transformation technique.

## II. THE PREFLEXING TECHNOLOGY

When the steel is covered by concrete in the conventional manner, the concrete on the tension flange of the composite beam cannot be counted on for any moment resistance because of the extremely low tensile strength of concrete. Because of this inherent weakness of concrete, crack formation in the tensile region of ordinary composite beams is unavoidable. The development of prestressed concrete has solved the problem of tension cracks in normal reinforced concrete beam by subjecting the tension area of the beam to a previously applied compressive stress [1].

Prestressing technology requires individual wires or cables to be tensioned by jacking either before or after the concrete is placed and cured [1]. However, the preflexing method uses the steel beam itself to introduce prestress into the concrete in the tension area. This method of prestressing implies that even the concrete in the tension area is effective, and hence, does not crack. As a composite structure of steel-concrete, preflex beam has the mechanical behavior between that of a steel beam and a prestressing concrete beam [5]. To introduce compressive stress in the tension area concrete, the bare steel beam is deflected by means of jacks until stresses approaching the yield point are reached in the tension flange. This operation is termed preflexing (Fig. 1 (b)). With the beam in this deflected position, a slab of concrete is poured around the tension flange (Fig. 1 (c)). When this concrete has hardened sufficiently to achieve the desired strength, the preflexing forces are released and the beam tends to return to its original profile (Fig. 1 (d)). However, due to the presence of the tension flange concrete, and its composite action with the steel, the beam now has a higher stiffness and full return is not possible. Thus, a higher load is now required to produce a given deflection than before with the bare steel only [2]. After transporting the beam to the site of construction, the concrete slab covering compression flange and web (depending on the design) is cast and the construction is completed (Fig. 1 (e)). This method results in obtaining a girder of low depth to span ratio and possessing high stiffness properties [2]. Fig. 1 shows the main stages of construction through (a) to (e).

Nasiri Ahmadullah (Master's student) is with the University of the Ryukyus, Senbaru 1, Nishihara, Okinawa, 903-0213 Japan (phone: 050-3719-9423, e-mail: ahmadullah.1415@gmail.com).

Shimozato Tetsuhiro (Associate professor) and Tai Masayuki (Assistant professor) are with the Department of Civil Engineering and Architecture, University of the Ryukyus, Senbaru 1, Nishihara, Okinawa, 903-0213 Japan (e-mail: simozato@tec.u-ryukyu.ac.jp, tai@tec.u-ryukyu.ac.jp).

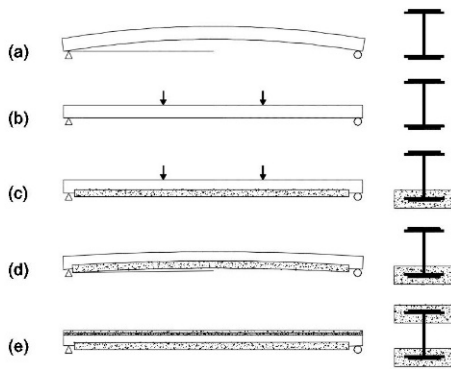

Fig. 1 Preflex beam construction stages

### III. ELASTIC THEORY

The elastic theory predicts stresses in flexural members with the common expression as follows:

$$F = \frac{M}{S} = \frac{M y}{I} \quad (1)$$

where,  $F$  = Bending stress ( $\text{N}/\text{m}^2$ ),  $M$  = Applied bending Moment ( $\text{N}\cdot\text{m}$ ),  $S$  = Section modulus ( $\text{m}^3$ ),  $y$  = Distance of the fiber of interest from the neutral axis ( $\text{m}$ ),  $I$  = Moment of inertia of the section ( $\text{m}^4$ ).

For sections composed of materials with different properties, the material with the lower stiffness, usually concrete, is transformed to an equivalent area of the one with higher stiffness usually steel. The transformation of the section occurs in the plane perpendicular to the plane of loading only. The process applies to the section based on the modular ratio ( $n$ ) which comes from moduli of elasticity of steel and concrete, as shown in (2):

$$n = \frac{E_s}{E_c} \quad (2)$$

$n$  = Modular ratio,  $E_s$  = Modulus of elasticity of steel ( $\text{N}/\text{m}^2$ ),  $E_c$  = Modulus of elasticity of concrete ( $\text{N}/\text{m}^2$ ), Stresses in extreme fibers of steel ( $F_s$ ) and concrete ( $F_c$ ) are calculated using properties of the transformed section, respectively, as:

$$F_s = \frac{M}{S} \quad F_c = \frac{M}{S} \frac{1}{n} \quad (3)$$

### IV. CONSTRUCTION PROCEDURE

#### A. Preflexing

The construction starts with preflexing the bare steel beam by the preflexion load using the four-points-bending method. The preflexion load  $P$  is acting downward, while the supports react opposite. The preflexion load is supposed to produce a maximum stress of no more than 75% of the yield strength of the steel [1]. Fig. 2 shows the loading diagram at this part of the construction.

Section properties are obtained and stresses in the extreme tension and compression fibers are computed using (1).

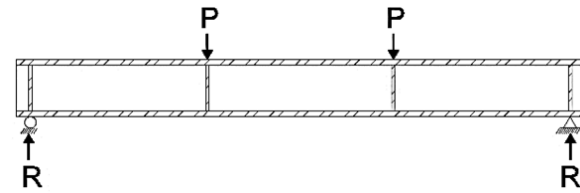

Fig. 2 Loading diagram at preflexion stage

#### B. Lower Flange Concrete Casting

After the steel beam is loaded with the preflexing load and it has reached the required level of stress and deflection, high strength concrete is cast around the lower flange of the beam. Concrete is designed to be compressed with no more than around 45% of its compressive strength after release stage [1]. From this point on, the section contains a new material with properties different than steel. The concrete needs 3-4 days depending on the mix design to harden to a required strength.

#### C. Preflexion Release

After the concrete around the lower flange has hardened enough, preflexion loads are removed to introduce pre-compressive stress to concrete. Since the section is a composition of two materials at this stage, the section properties need to be recalculated.

The section is transformed to an equivalent section of a single material using the modular ratio in (2). The effects of removing the preflexing load are represented mathematically by applying a load equal to the preflexing load, but oppositely directed, as shown in Fig. 3.

It should be mentioned that stresses resulting from weight of materials are also considered in this stage, since the weight loads act in the opposite direction of the release load.

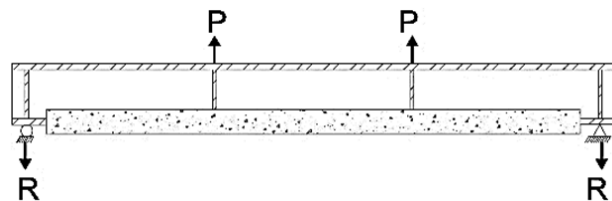

Fig. 3 Loading diagram at release stage

#### D. Upper Flange Concrete Casting

Once the preflexing loads are removed, the lower flange concrete is prestressed. After the beam is ready, it is transported to the site of the construction and upper flange concrete is poured per the design details. In some cases, the web is also covered with the upper flange; while, in other cases the concrete does not cover the web. Generally, changes in stress caused due to the addition of compression concrete in this stage are calculated using the common formula (1), having steel, lower flange concrete and compression concrete involved. The properties for the section are obtained and stress calculations are worked out.

### V. STRESSES IN THE BEAM SECTION

The elastic theory predicts stresses in the section during

construction stages. It also can be used to predict changes in stresses which occur in preflexed beams when they are subjected to working loads. Conversely, test results indicate that elastic theory cannot be used to predict the amount of prestress loss, nor the initial stress condition in a preflexed beam before working loads are applied [1].

Stresses in the section of the preflexed beam after the preflexing load is removed, can be obtained from the accumulation of stresses developed in the preflexion and release stages. However, no predictions are possible about the amount of stress available in the section before casting the compression concrete and just before application of service load. The main reason is that the prestress loss from the time of release that of casting compression concrete and application of service load is not known.

VI. RESULTS

Reference [1] studies application of elastic theory for computing flexural stresses in the preflex beam. Per the results obtained from the study, elastic theory can be used to predict stresses in the section satisfactorily.

The study uses experimental approach on a 10ft (3.048 m) long 8WF17 beam constructed utilizing preflexion method of prestressing with load of 14450 lb (64273.6 N) applied at the third points. The beam is stiffened with stiffeners at the ends and third points, which are used for applying the preflex load.

The beam specimen is flat with no camber; however, it does not affect the purpose of the experiment, being the study on the preflexing method of prestressing.

Fig. 4 shows the dimensions of the composite section used for the experiment. Theoretical and experimental values of flexural stresses have been compared to confirm the applicability of the elastic theory on preflex beams.

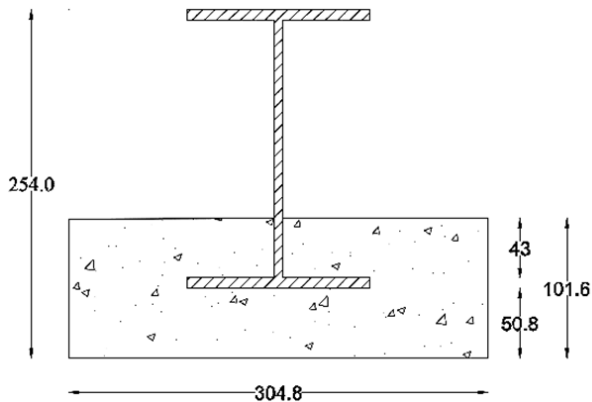

Fig. 4 Section of the experimental specimen (units: millimeter) [1]

In the current study, only FEM analysis is carried out for the specimen used in the experimental study in [1], under the same loading conditions. The results for flexural stresses in preflexion and release stages are compared to those of the experimental study. The theory and experiment data in this paper come from the study in [1].

TABLE I  
STEEL STRESS (MPA) IN PREFLEXION STAGE

Case	Top Fiber	Bottom Fiber
FEM	-291.1	291.1
Theory	-268.895	268.895
Experiment	-292.337	279.237

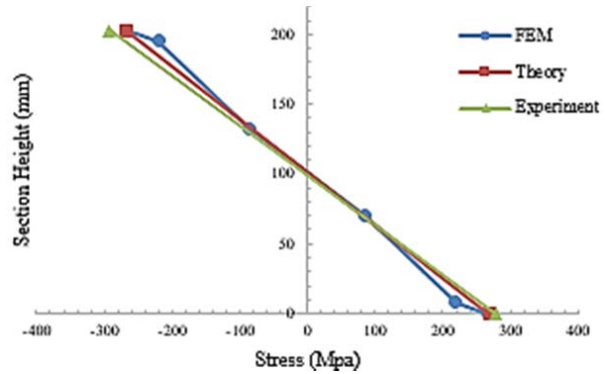

Fig. 5 Steel stresses in preflexion stage

TABLE II  
STEEL STRESS (MPA) AFTER RELEASE

Case	Top Fiber	Bottom Fiber
FEM	-38.78	155.42
Theory	-58.6054	179.2637
Experiment	-25.5106	146.8583

Figs. 5 and 6 present and compare results tabulated in Tables I and II, obtained from the FEM with those from experiment and theory. Theoretical, experimental and FEM stress values in the steel section in Fig. 5, meet one another with narrow margins all over the section height. This confirms agreement of the results.

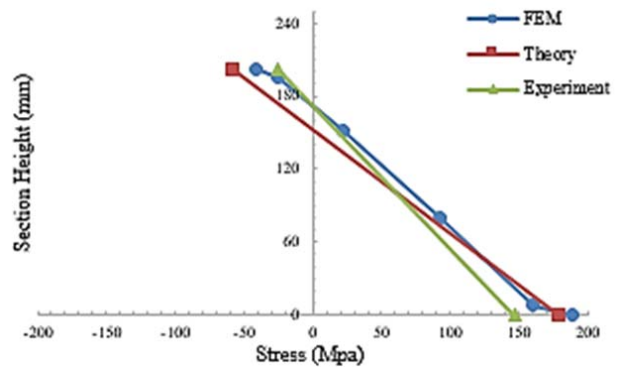

Fig. 6 Steel stresses after release stage

The graphical presentation of steel stresses after release stage, as seen in Fig. 6, matches within an acceptable range. The slight difference comes from the nature of the release process, being different in simulation and practice. Furthermore, simulation of the contact situation depending on the surface friction between steel and concrete, alongside with no consideration of stiffeners in theory calculations, can be the root sources for the differences.

TABLE III  
CONCRETE STRESSES (MPa) AFTER RELEASE

Case	Top Fiber	Bottom Fiber
FEM	-0.8721	-13.05
Theory	-1.31	-15.3753
Experiment	-2.13737	-20.3395

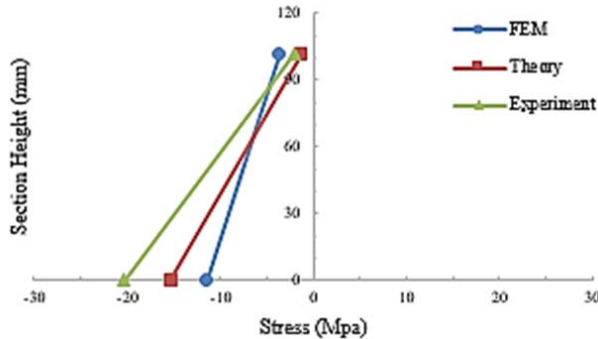

Fig. 7 Concrete prestress introduced by preflexion

Fig. 7 graphs the values in Table III, present stresses in concrete fibers just after the preflexion load are removed. FEM predicts smaller stress in the concrete bottom fiber in practice, while it is vice versa for the top fiber. The difference comes from the instant changes in the concrete properties, and the different natures of approaches for the release stage in practice, theory and FEM.

## VII. CONCLUSION

The graphical presentations of stress values in the preflexion and release stages, confirm that the FEM results meet the experimental and theoretical results to an acceptable level of satisfaction. The relative difference in values of stresses, root from shortage in fulfillment of exact simulation of the material properties, loading conditions and assumptions made in different cases of analyses. Generally, the comparison gives a fair enough idea of behavior of the preflex beam in the construction stages, and confirms that elastic theory can be used to predict stresses in preflex beams.

## REFERENCES

- [1] Frank A. Mink, Jr, "An Experimental Investigation of Preflex method of prestressed concrete", Georgia Institute of Technology, May 1955, Ch.2, 3, 5 and 7.
- [2] D. W. Haines, C. P. Pitts, S. J. Errera, "Tests of Preflexed beams", Fritz Engineering Laboratory Report No.282.1, September 1961.
- [3] PAP, Zsuzsa Borbala, "PREFLEX girders: Prefabricated composite bridges", Bauhaus Summer School in Forecast Engineering, Weimar, Germany, 17-29 August 2014.
- [4] S. Staquet, F. Toutlemonde, "Test up to ultimate limit state and failure of innovative prebended steel-VHPC beams for railway bridges in France".
- [5] Kebo Zhang, Suping Li, Kaisheng Liu. "Experimental Study on Static and Fatigue Behaviour of Steel-Concrete Preflex Prestressed Composite Beam".