

Modular Harmonic Cancellation in a Multiplier High Voltage Direct Current Generator

Ahmad Zahran, Ahmed Herzallah, Ahmad Ahmad, Mahran Quraan

Abstract—Generation of high DC voltages is necessary for testing the insulation material of high voltage AC transmission lines with long lengths. The harmonic and ripple contents of the output DC voltage supplied by high voltage DC circuits require the use of costly capacitors to smooth the output voltage after rectification. This paper proposes a new modular multiplier high voltage DC generator with embedded Cockcroft-Walton circuits that achieve a negligible harmonic and ripple contents of the output DC voltage without the need for costly filters to produce a nearly constant output voltage. In this new topology, Cockcroft-Walton modules are connected in series to produce a high DC output voltage. The modules are supplied by low input AC voltage sources that have the same magnitude and frequency and shifted from each other by a certain angle to eliminate the harmonics from the output voltage. The small ripple factor is provided by the smoothing column capacitors and the phase shifted input voltages of the cascaded modules. The constituent harmonics within each module are determined using Fourier analysis. The viability of the proposed DC generator for testing purposes and the effectiveness of the cascaded connection are confirmed by numerical simulations using MATLAB/Simulink.

Keywords—Cockcroft-Walton circuit, Harmonics, Ripple factor, HVDC generator.

I. INTRODUCTION

GENERATION of high direct voltage is used to test equipment related to HVDC systems. It can be also used in insulation test for long power cables. High DC voltages are used in many other applications such as biomedical applications (X-rays), communications electronics (TV), applied physics (accelerators) and industrial applications (electrostatic painting) [1]-[3].

They are many circuits used to generate high DC voltages such as half and full wave rectifier circuits, voltage doubler circuits, and voltage multiplier Cockcroft-Walton circuit.

The half and full wave rectifiers have many advantages such as they are simple, easy to implement and cheap. However, they generate high ripples and harmonics in the output voltage, have very low transformer utilization factor and efficiency, and the size of their elements are very large if pure DC output voltage is needed. In the case of full wave rectifier, the use of center tapped transformer makes the rectifier more expensive and bulkier [1], [2].

When higher DC voltages are required to be generated, the voltage doubler circuits are used. The voltage doubler circuits have many features compared to rectifier circuits. They can produce an average output voltage twice the peak value of the

source voltage. However, they have many disadvantages such as poor voltage regulation, high capacitor voltage ratings, and high ripples, and harmonics in the output voltage [1]-[3].

Since the voltage doubler cannot generate voltage more than twice the peak value of the input voltage, a cascade doubler circuit is used. The cascade doubler circuit has major feature than other types since it has higher power capabilities. However, the cascading of every stage would thus require an additional isolating transformer which makes this circuit less economical for high number of stages [4].

The main advantage of the Cockcroft-Walton circuit is to generate high voltage DC from power supply without need an expensive high voltage transformer, therefore the cost and size of the circuit is small. Moreover, it is simple in implementation since it consists of cascaded connection of diodes and capacitors. On the other hand, this topology has many disadvantages such as low regulation and high ripple factor and harmonics for large number of stages [5]-[7].

This paper presents a new modular cascaded DC generator based on Cockcroft-Walton circuits to produce a high DC voltage. The proposed topology is able to cancel the harmonic of ripples caused by driving voltage. Moreover, the proposed topology has many advantages. These include smaller size, modular design, lighter weight, less component counts, easier implementation, faster transient response and smaller voltage drop.

II. GENERATOR STRUCTURE AND OPERATION PRINCIPLE

The layout of the proposed generator is represented in the schematic of Fig. 1, where the sub-modules (SMs) consists of a single Cockcroft-Walton circuit with n stages. Each SM is supplied by an isolated AC source such that the sources are balanced and have equal magnitude, frequency and angle separation. The SMs are then connected in cascade to form the total output DC voltage.

The operation principle of the Cockcroft-Walton circuit can be explained with reference again to Fig. 1. If the source voltage has a peak value of V_p , the capacitor C_1 will be charged up to the voltage V_p . The voltage at node 1' oscillates between zero and $2V_p$ with respect to 0. When the voltage at node 1' becomes $2V_p$, the capacitor C_1 is charged through the diode D_1 . During the next half cycle when 1' decreases with respect to 0, the voltage at node 2' also decreases and becomes less than the voltage at node 1 with respect to 0, hence the capacitor C_2 is charged through D_1' and D_2' . In the next half cycle, the voltages at nodes 1' and 2' increase, thus C_2 is charged through the diodes D_1 and D_2 . Finally, all the capacitors are charged. The voltage across the capacitors C_1 ,

Ahmad Zahran, Ahmed Herzallah, Ahmad Ahmad, Mahran Quraan is with the Birzeit University, Palestine (e-mail: ahmadzahran95@gmail.com, ahmedissa@live.com, ahmadsaeed2022@gmail.com, mquraan@birzeit.edu).

$C'_2 \dots C'_n$, keeps on oscillating as the source voltage alternates between V_p and $-V_p$. These capacitors, therefore, are known as oscillating capacitors. However, the voltage across the capacitances $C_1, C_2 \dots C_n$ is fixed, and these capacitors, therefore, are known as smoothing capacitors. The voltages at nodes 1, 2 ... n with respect to 0 are $2V_p, 4V_p \dots 2nV_p$. Therefore, voltage across all the capacitors is $2V_p$ except for C_1 where it is V_p only. The total output voltage is $2nV_p$ under no load condition, where n is the number of stages. Thus, the use of multistage arranged in the manner shown enables very high voltage to be obtained. The equal stress of the elements (both capacitors and diodes) used is very helpful and promotes a modular design of such generators [1].

With m sub-modules, this generator produces $2mnV_p$ DC voltage under no load condition. Due to voltage level of sub-modules (SMs), the energy stored within the Cockcroft-Walton circuit is accordingly low and the voltage stress across each switching device is limited to the voltage of one SM.

The sketch in Fig. 2 shows the typical shape of the normalized output voltage of one SM, assuming that all the capacitors within the cascade circuit are equal. The output voltage will never reach the value $2nV_p$ and there will also be a ripple on the voltage. The fast Fourier transform (FFT) analysis of the output voltage is shown in Fig. 3 where the y-axis shows the magnitude of each harmonic relative to the DC component of the waveform. The total harmonics distortion relative to the DC component, THD_{DC} can be calculated as:

$$THD_{DC} = \frac{\sqrt{\sum_{h=1}^{\infty} V_h^2}}{V_{DC}} \quad (1)$$

where V_h is the RMS voltage of the h -th harmonic. It is clear that the waveform contains a significant odd harmonics and insignificant even harmonics. The odd harmonics are associated with the half-wave symmetrical shape of the signal.

The instantaneous output voltage of each SM can be represented by using Fourier series as:

$$v_k = V_{DC} + \sum_{h=1}^{\infty} V_h \sin(h(\omega t + \phi_k)), \quad k \in \{1 \ 2 \ \dots \ m\} \quad (2)$$

being m the number of SMs in the proposed DC generator and V_{DC} is the average DC voltage of the k -th SM for Cockcroft-Walton circuit, which is given by [1]:

$$V_{DC} = \left(2nV_p - \frac{2I}{3fC} n^3 \right) \quad (3)$$

where I is the load current, f is the source frequency and C is the generator capacitance.

To eliminate the harmonics and ripples from the total output voltage, the modules are supplied from input AC voltage sources having the same magnitude and frequency and shifted from each other by an angle $2\pi/m$. This phase shift can be easily obtained by designing a special low power multiphase-

multipole synchronous machine to feed all SMs via isolating transformers. The generation of the multiphase voltages to feed the proposed HVDC generator is not discussed in this paper and will be considered in future papers.

Since the sources are assumed to be shifted from each other by the angle $2\pi/m$, the instantaneous output voltages from all SMs can be represented as:

$$\begin{aligned} v_1 &= V_{DC} + \sum_{h=1}^{\infty} V_h \sin(h(\omega t + \phi_1)) \\ v_2 &= V_{DC} + \sum_{h=1}^{\infty} V_h \sin(h(\omega t + \phi_1 + 2\pi/m)) \\ v_3 &= V_{DC} + \sum_{h=1}^{\infty} V_h \sin(h(\omega t + \phi_1 + 4\pi/m)) \\ &\vdots \\ v_m &= V_{DC} + \sum_{h=1}^{\infty} V_h \sin(h(\omega t + \phi_1 + 2\pi(m-1)/m)) \end{aligned} \quad (4)$$

In this case, the instantaneous total output voltage is the sum of individual output voltages from all SMs:

$$\begin{aligned} v_o &= \sum_{i=1}^m v_i \\ v_o &= mV_{DC} + \sum_{k=0}^{m-1} \sum_{h=1}^{\infty} V_h \sin(h(\omega t + \phi_1 + 2\pi k/m)) \\ &= mV_{DC} + \sum_{h=1}^{\infty} \sum_{k=0}^{m-1} V_h \sin(h(\omega t + \phi_1 + 2\pi k/m)) \\ &= mV_{DC} + \sum_{h=1}^{\infty} \sum_{k=0}^{m-1} V_h \left[\cos(2\pi kh/m) \sin(h(\omega t + \phi_1)) + \right. \\ &\quad \left. + \sin(2\pi kh/m) \cos(h(\omega t + \phi_1)) \right] \\ &= mV_{DC} + \sum_{h=1}^{\infty} A_h V_h \sin(h(\omega t + \phi_1)) + \sum_{h=1}^{\infty} B_h V_h \cos(h(\omega t + \phi_1)) \end{aligned} \quad (5)$$

where A_h and B_h are given by:

$$\begin{aligned} A_h &= 1 + \cos(2\pi h/m) + \cos(4\pi h/m) + \dots + \cos(2\pi h(m-1)/m) \\ B_h &= \sin(2\pi h/m) + \sin(4\pi h/m) + \dots + \sin(2\pi h(m-1)/m) \end{aligned} \quad (6)$$

Using the following sine and cosine series:

$$\begin{aligned} \cos(x) + \cos(2x) + \dots + \cos((m-1)x) &= \frac{\sin((m-1)x/2) \cos(mx/2)}{\sin(x/2)} \\ \sin(x) + \sin(2x) + \dots + \sin((m-1)x) &= \frac{\sin((m-1)x/2) \sin(mx/2)}{\sin(x/2)} \end{aligned} \quad (7)$$

A_h and B_h can be further represented as:

$$\begin{aligned} A_h &= 1 + \frac{\sin((m-1)\pi h/m) \cos(\pi h)}{\sin(\pi h/m)} = 0 \\ B_h &= \frac{\sin((m-1)\pi h/m) \sin(\pi h)}{\sin(\pi h/m)} = 0; \quad h \neq im \text{ where } i = 1, 2, 3, \dots \end{aligned} \quad (8)$$

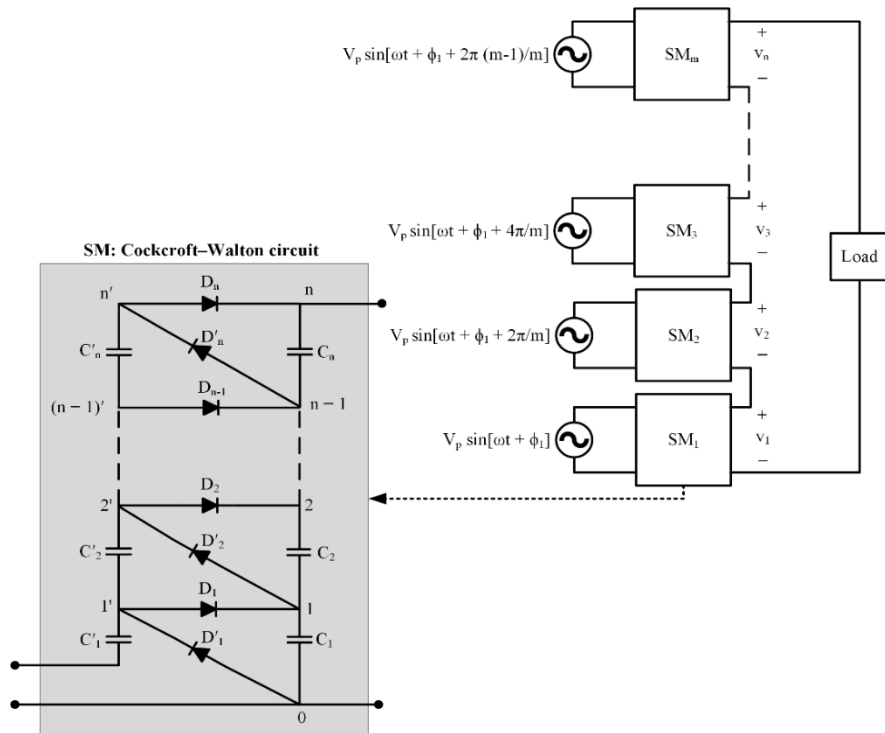

Fig. 1 Layout of the proposed modular HVDC generator with embedded Cockcroft-Walton circuits

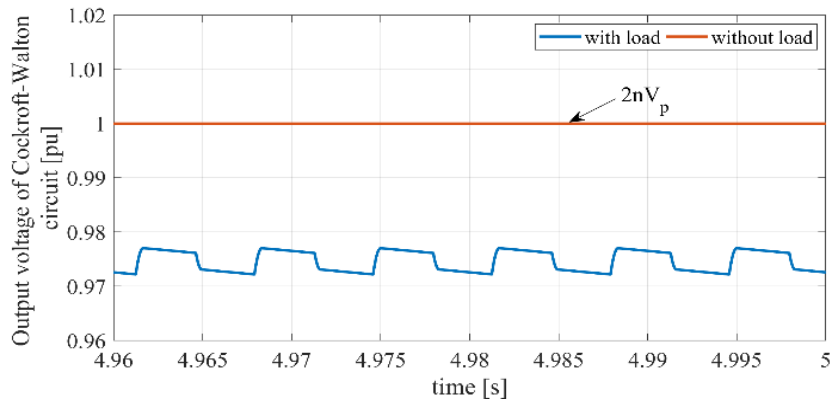

Fig. 2 The typical steady state output voltage waveform under load and no-load conditions

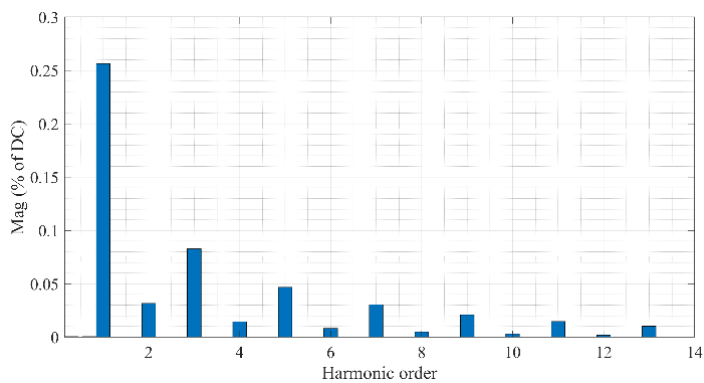

Fig. 3 FFT analysis of the typical output voltage waveform under load condition

The last equation shows that when m is even, the output voltage of the generator contains only even harmonics. When m is odd, the output voltage of the generator contains both even and odd harmonics. Therefore, the THD_{DC} will be smaller when m is even which means less ripple factor in the output waveform. The harmonics are eliminated, and the generator will provide ideally a pure DC output voltage with zero ripple factor as long as m is very large.

III. SIMULATION RESULTS

The operating characteristics of the proposed HVDC generator with embedded Cockcroft-Walton circuits have been tested by means of numerical simulations obtained from MATLAB/Simulink (SimPower System Library). In this simulation, the source frequency is set to be 150 Hz, the load current is $0.06 \mu A$, the number of stages per each SM is 4, and the generator input AC sources have been simulated as ideal AC voltage sources with peak value of 125 kV.

Fig. 4 shows the normalized output voltages, on the base of 1 MV, which are supplied by the SMs for different numbers of m . The output voltages are shifted from each other by 180° , 120° , 90° , 72° , or 60° when m equals 2, 3, 4, 5, or 6, respectively. This is necessary to cancel the significant odd harmonics from the output voltage of each SM.

Fig. 5 shows the steady state normalized output voltages, for different base voltages, from the proposed generator at

different numbers of SMs.

The FFT analysis of the output voltage is shown in Fig. 6 where the y-axis shows the magnitude of each harmonic relative to the DC component of the waveform. It is clear that when m is even (e.g. $m = 2$ or 4), the output voltage of the generator contains only even harmonics. When m is odd (e.g. $m = 3$ or 5), the output voltage of the generator contains both even and odd harmonics. Therefore, the ripple factor of the output voltage will be smaller when m is even. Fig. 7 summarizes the THD_{DC} at different values of m .

IV. CONCLUSION

This paper presents a new modular multiplier HVDC generator to test HVAC power cables of long length, based on the series connection of Cockcroft-Walton modules. The modules are supplied by low input AC voltage sources that have the same magnitude and frequency and shifted from each other by a certain angle. A mathematical model for the harmonic contents in the output DC voltage has been presented in the paper. The total harmonic distortion relative to the DC component and the ripple factor of the output voltage will be very small when the number of series connected modules is even. The proposed generator is therefore a suitable candidate to eliminate harmonic and ripple contents of the output DC voltage.

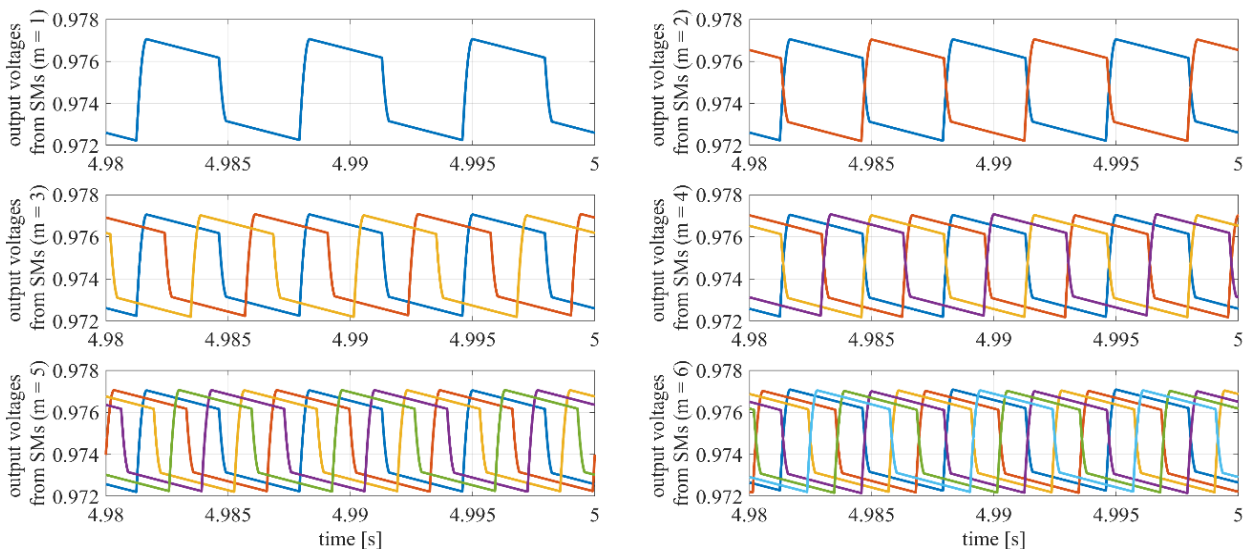

Fig. 4 Steady state SM voltages for different number of SMs

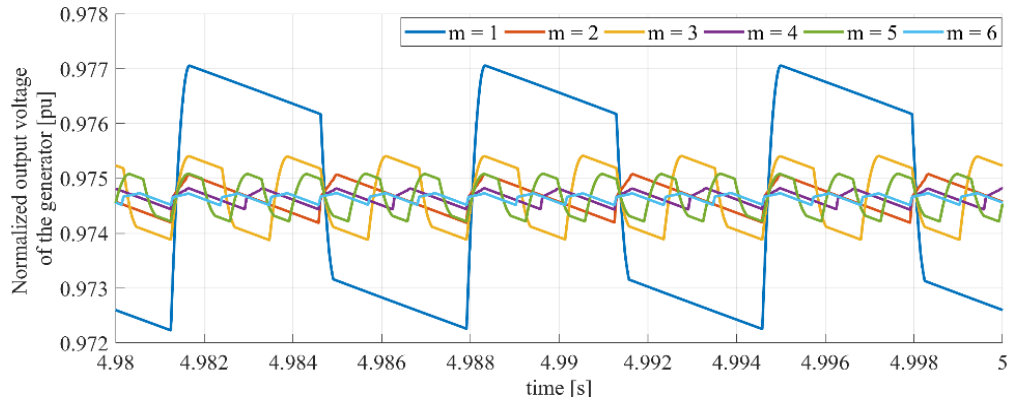

Fig. 5 Steady state normalized output voltages from the proposed generator for different number of SMs

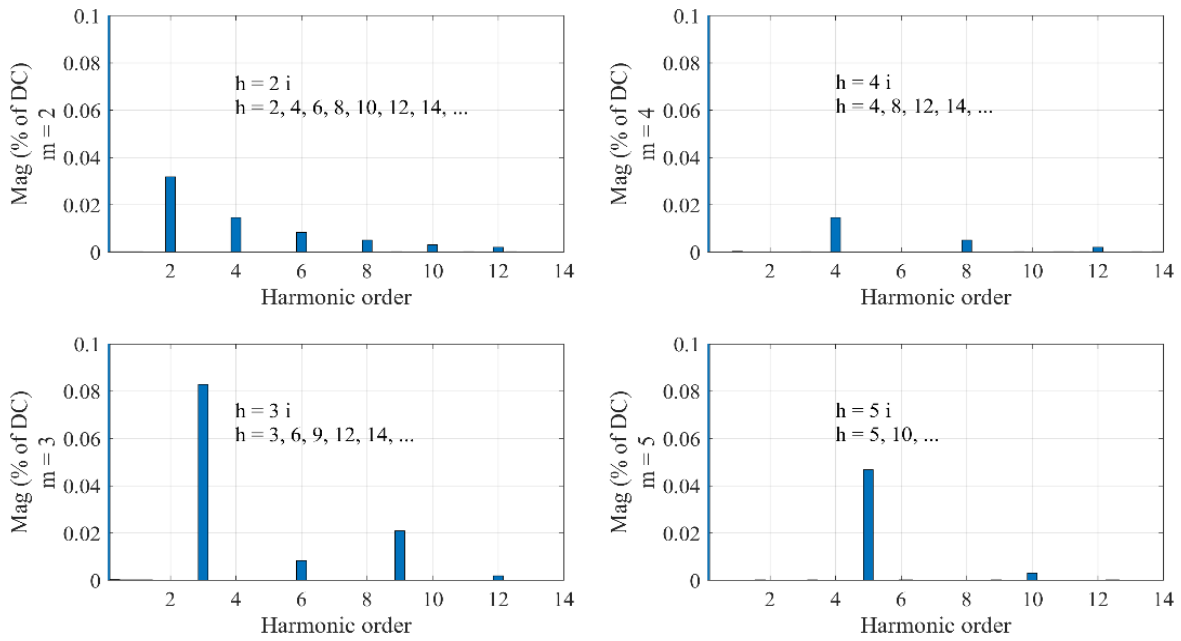

Fig. 6 FFT analysis of the generator output voltages ($m = 2, 3, 4 \& 5$)

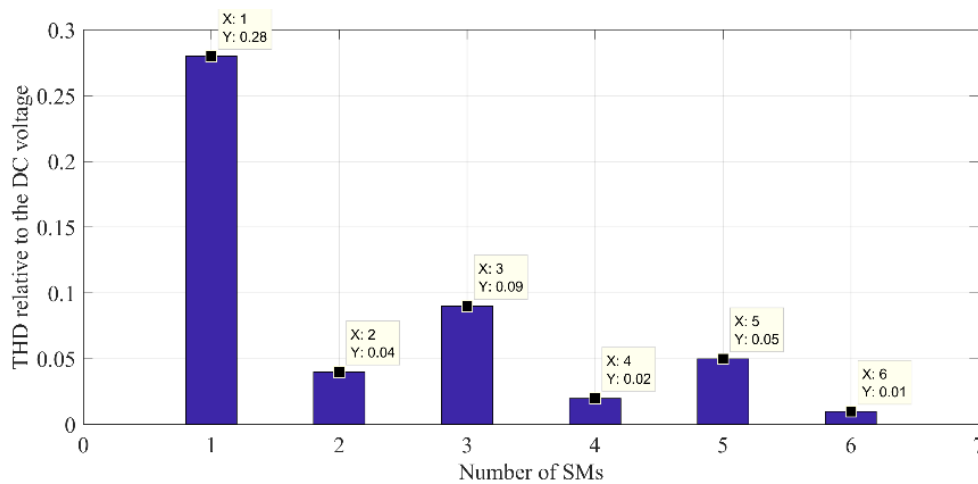

Fig. 7 The total harmonic distortion relative to DC component for different number of SM

The proposed generator has been tested with simulations on a simulated model with four stages per SM, having load current of 0.06 μ A, and each module is supplied by separate AC source with peak value of 125 kV and frequency of 150 Hz. The tests have demonstrated the correct operations of the generator to reduce harmonic and ripple contents of the output DC voltage.

REFERENCES

- [1] E. Kuffel, W. S. Zaengl, 1984, *High Voltage Engineering Fundamentals*, 2nd edition, Generation of high voltages, Pergamon Press, pp. 11-14.
- [2] C. L. Wadhwa, 2006, *High voltage engineering*, 2nd edition, Generation of High D.C. and A.C. Voltages, New Age International, pp. 56-59.
- [3] <http://www.circuitstoday.com/half-wave-rectifiers>. (Accessed March 15, 2018).
- [4] M. S. Naidu, & V. Kamaraju, 1996, *High voltage engineering*, 2nd edition, Generation of High voltages and currents, McGraw-Hill, pp. 106-109.
- [5] <http://www.essay.uk.com/essays/engineering/low-to-high-dc-voltage-generating-device>. (Accessed March 20, 2018).
- [6] S. Iqbal and R. Besar, "A Bipolar Cockcroft-Walton Voltage Multiplier for Gas Lasers," *American Journal of Applied Sciences*, vol. 4, no. 10, pp. 795-801, 2007.
- [7] N. Barsoum and G. Stanley, "Design of High Voltage Low Power Supply Device," *Universal Journal of Electrical and Electronic Engineering*, pp. 6-12, 2015. doi: 10.13189/ujeee.2015.030102.