

The Effect of Critical Activity on Critical Path and Project Duration in Precedence Diagram Method

J. Nisar, S. Halim

Abstract—The additional relationships i.e., start-to-start, finish-to-finish, and start-to-finish, between activity in Precedence Diagram Method (PDM) provides a more flexible schedule than traditional Critical Path Method (CPM). But, changing the duration of critical activities in the PDM network will have an anomalous effect on the critical path and the project completion date. In this study, we classified the critical activities in two groups i.e., 1. activity on single critical path and 2. activity on multi-critical paths, and six classes i.e., normal, reverse, neutral, perverse, decrease-reverse and increase-normal, based on their effects on project duration in PDM. Furthermore, we determined the maximum float of time by which the duration each type of critical activities can be changed without affecting the project duration. This study would help the project manager to clearly understand the behavior of each critical activity on critical path, and he/she would be able to change the project duration by shortening or lengthening activities based on project budget and project deadline.

Keywords—Construction project management, critical path method, project scheduling, precedence diagram method.

I. INTRODUCTION

SCHEDULE is the key element in the management of construction projects. A project schedule establishes the start date, duration, completion date, and resource needs for each activity in the project. Mistakes in the schedule may cause the project team to allocate resources to the wrong place at the wrong time or may prevent the parties from accurately assessing the information of whether the project is ahead of or behind the schedule.

CPM, developed in the 1950s, is a powerful network diagramming for the representation of activities of project. The CPM has been widely used as a construction project management tool to improve scheduling and project administration tasks, and supporting project managers to ensure a project to be completed on time and within the budget [1].

In CPM, once the project network is drawn, the following steps are performed: (i) a forward pass to determine the earliest start time (ES) and earliest finish time (EF) for activities, (ii) a backward pass to determine the latest start time (LS) and latest finish time (LF) for activities, (iii) float calculations and (iv) identification of critical activities and critical path(s). This information is very important for the

project manager to plan and control the project more actively and efficiently [1].

Critical path and Float are the most important concepts among all the information in a project schedule. There are several types of floats, of which, the simplest and most important type of float is total float (TF) and free float (FF). TF is defined as the maximum amount of time for which an activity can be delayed without affecting the completion date of the project. TF is computed as the difference between LS and ES or between LF and EF of an activity. However, the free float (FF) is defined as the amount of time for which an activity can be delayed without affecting the start time of any succeeding activities in the project. FF can be calculated as the difference between the earliest ES among all the immediate successors of an activity and the EF of that activity. Critical path is the longest ordered sequence of activities through the project schedule, and it determines the earliest time by which a project can be completed. This time is often known as the project duration, but more commonly as the critical path. A schedule may have more than one critical path. Each activity in a critical path is known as a critical activity. The critical activity has zero TF. When any of them is delayed, it causes a delay in the project completion date. However, the traditional CPM was essentially limited to finish-to-start (FS) relationships between activities, i.e., the successor activity cannot start until the predecessor activity is completed. Therefore, it could not allow overlapping unless activities were further divided [2]. PDM, which was developed based on the concept of CPM analysis, introduced three alternative relationships, i.e., start-to-start (SS), finish-to-finish (FF), and start-to-finish; and lag factor between various activities. The PDM is also called activity on node (AON) network, and some authors call both methods (CPM and PDM) as CPM. PDM with three additional relationships between activities has provided a more flexible realistic project representation in schedule networks and more accurately reflects the sequence of construction operations as they occur in real life [1]. There are various computer software packages available such as Primavera P6 and MS Project, which provide the PDM schedule.

PDM seems to be friendlier when compared to the CPM. For example, suppose that providing a concrete floor for a warehouse needs three construction activities. Let, activity A be “install formwork, activity B be “reinforcement arrangement”, and activity C be “pour concrete”. The duration of each activity is estimated as 4 days, 4 days and 2 days, respectively. Based on the CPM assumption, the technological relationship between these three activities will be finish-to-

J. Nisar is an Assistant Professor with Department of Civil Engineering, Kabul University, Kabul, Afghanistan (phone: +93-79-855-5657; e-mail: jafar.nisar@yahoo.com).

S. Halim is an Associate Professor with Department of Civil Engineering, Kabul University, Kabul, Afghanistan (phone: +93-744-388-649; e-mail: sefat_halim@yahoo.com).

start, and they have to be executed as a series. Therefore, the project duration would be 10 days. Whereas, in PDM, as shown in Fig. 1, activity A “reinforce arrangement” and activity B “install formwork” can be executed concurrently so that start-to-start with two days lag would be the proper relationship between them. Thus, the PDM relationship reduces the project duration to 8 days. However, the new relationships of PDM can change some of the basic concepts of critical activities and critical path [3], [4]. According to the basic definition of a critical activity in CPM, the shortening/lengthening of a critical activity on a critical path always results in decreased/increased project duration. But, this definition does not always apply on PDM. Crashing some critical activity in PDM in order to reduce the project duration can have anomalous effects [3], [4].

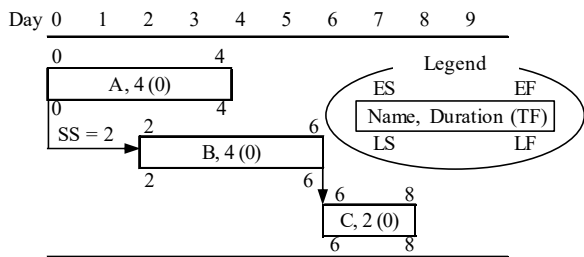

Fig. 1 PDM schedule with SS relation

To better illustrate the anomalous effect of new relationships of PDM on critical activities, consider the simple project schedule that shows on Activity-on-Arrow network in Fig. 2. Each rectangle in a network represents a project activity. The technological relationships between activities are indicated by arrows. The project consists of seven activities. Activity S and activity F are assumed to be artificial activities indicating the project commencement and the project

completion, respectively. The results of CPM calculation are shown in Fig. 3 as bar-chart fashion along a horizontal time scale. The sequence of activities and precedence arrows, denoted by a bold line, represent the critical path. As shown in Fig. 3, we can identify activity 1, activity 4, activity 5, activity 6, and activity 7 as critical (zero total float). First, let us define the characteristics of a critical activity in traditional CPM as: (i) any delay in the start time of a critical activity will result in a delay in the project duration, (ii) any change in the length of a critical activity will result the same change in the entire project duration. The first characteristic is true on all critical activities in schedule network in Fig 3. The second characteristic is still true of critical activity 1, activity 6, and activity 7. However, this characteristic cannot be true for critical activity 4 and activity 5. For example, shortening activity 4 would reversely effect on project duration, meaning it will increase the project duration. Conversely, lengthening it will decrease the project duration. Also, shortening and lengthening of activity 6 has no effect on project duration. As shown in Fig. 3, these anomalous affects are indicated for critical activities that have SS and/or FF relationships.

In this paper, we provide some important information for critical activity effect on project duration. In addition, we determine the maximum amount of time by which changing the duration of a critical activity will have anomalous effect on project duration. Therefore, the project manager will clearly distinguish the behavior of each critical activity on a critical path, and he can change the project duration by shortening/lengthening activities based on project budget and project deadline.

II. PREVIOUS STUDIES

Some previous researchers have studied on critical activity and critical path in PDM.

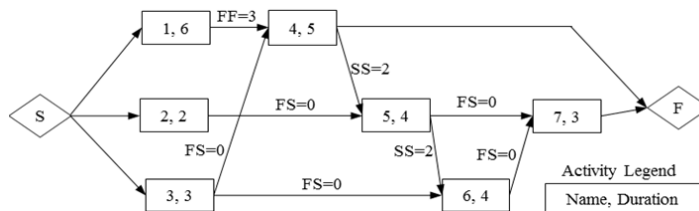

Fig. 2 PDM schedule network

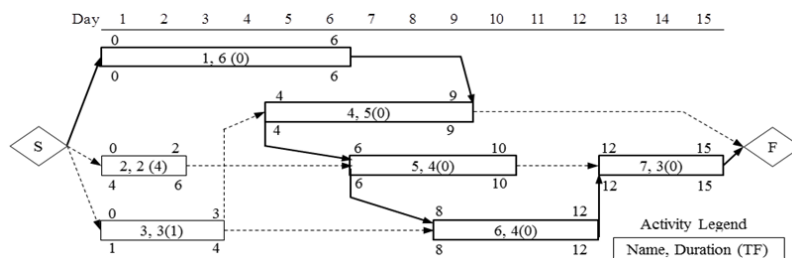

Fig. 3 PDM schedule network on horizontal time scale

Lu and Lam [5] proposed a “transform schemes” in order to detect and transform the new relationships of a PDM network

i.e., SS, FF, and SF, into equivalent FS relationship by splitting activities. However, some activity may require not to be split during its execution. Therefore, this scheme would not be feasible for such projects with non-interruptible activities.

Wiest [3] described the effects of critical activities with SS and FF relationships. He defined the critical path as an alternating sequence of activities and precedence arrows, starting and ending with activities or activity extreme points. Weist [3] classified the critical activities as primary classifications in a PDM network as *normal*, *reverse*, and *neutral*.

- 1) If a critical path passes through an activity from start to finish, then the activity's effect on the critical path or project duration is *normal*. Its lengthening will increase the critical path, and shortening it will have the opposite effect.
- 2) If a critical path passes through an activity from finish to start, then the activity's effect on the project duration is anomalous. Its lengthening will shorten the critical path, and its shortening will lengthen the path. Such critical activity is denoted as *reverse*.
- 3) If a critical path enters and exits from the starting point of an activity (or ending point), then the duration of activity is independent of the length of that critical path. The activity is called as *neutral* critical.

Wiest [3] also mentioned that when an activity is on more than one critical path, then the classification would depend on the combination of paths. The combination of *normal* and *reverse* is *perverse*, meaning if one critical path passes through an activity from start to finish and another one enters and exists from its starting point (or ending point), then whether the activity is shortened or lengthened, the project duration will be increased. Such activity is called *perverse* critical. He also stated that the combination of *normal* and *neutral* is *normal*, the combination of *neutral* and *reverse* is *reverse*, and the combination of all primary classification i.e., *neutral*, *normal*, and *reverse*, will be *perverse*. However, all these statements are not true. We will show in section IV that the combination of *normal* and *neutral*; and the combination of *neutral* and *reverse* will have different effects that Wiest [3] have proposed.

Moder et al. [6] proposed the same classification to the abovementioned. But the only difference is that they divided *neutral* into two classes i.e., start *neutral* and finish *neutral*, and also they named the *perverse* as *bicritical*.

These classifications provide useful information about the behavior of critical activities in a PDM network, when the project manager needs to change the length of critical activities. However, further study is needed in order to provide detailed information on the classification of critical activity effect. In addition, it is needed to determine how long (time) a certain effect of critical activity would be available during shortening/lengthening of such activity. Because, after shortening/lightening of a critical activity by a certain time unit(s), the activity's effect on project duration may be changed. For example, as the previous classification, activity 5 in Fig. 3 has a *neutral* effect, meaning its lengthening/

shortening would not change the project duration. However, when its duration is increased by 2 days, then it will change to *normal* critical, and then lengthening it will increase the project duration.

III. FORMULATION AND ASSUMPTION

We consider a single project schedule which is represented by an Activity-On-Arrow (AOA) network in which the activities are denoted by node (circle or rectangle) and the predecessor relationships between predecessor activity i and successor j is shown by an arrow connecting the two nodes. There may exist four types of relationships i.e., SF_{ij} , SS_{ij} , FF_{ij} , and FS_{ij} , with minimum lag time l_{ij} between activities i and j . Each activity is non-preemptive or cannot split during its execution. It is assumed that the resource requirement for each activity is unlimited. The start time of the project is considered as unit time 0. For each activity, the duration and precedence relations are assumed to be deterministic and known in advance.

To avoid having more start activities in the network, an artificial activity with zero duration is used as the start activity. If the start of an activity has no predecessor activity, then the start activity is nominated as its direct predecessor with FS relationship. An artificial activity is used as the finish activity. This also helps to have only one finish activity. If the finish of an activity has no successor activity, then the finish activity is used as its direct successor.

IV. CRITICAL ACTIVITIES CLASSIFICATION

Based on the location of critical activities in the schedule, we classify their effects in two groups i.e., activity on single a critical path and activity on a multi-critical path. If the critical activity is located on single path, it is called as primary classification by Wiest [3]. But, if it is located on a multi-path, then its effect will determine as their combination. The critical path in PDM may define as: the alternating sequence of activities and precedence arrows, starting and finishing with activities or activity extreme points. All the precedence arrows always move forward, and hence an increase in the length (lag time) of a critical precedence arrow will lengthen the project duration. The classifications are described in detailed and depicted in figures as follows. Note that each arrow in the figures represents the critical path direction.

A. Activity on Single Critical Path

If the activity is located on a single critical path, then it would classify as primary in three classes. The other classification will be provided by a combination of these three primary classes. In this paper, we accept the proposed primary classification by Wiest [3].

- 1) *Normal (N)*: denotes an activity that lengthening it will lengthen the project duration and shortening it will increase the project duration. Fig. 4 shows a normal critical activity that critical path ab passed through the activity from start to finish.
- 2) *Reverse (R)*: denotes an activity that lengthening it will shorten the project duration and shortening it will

decrease the project duration. Fig. 5 depicts the *reverse* critical activity in which a single critical path of ab passed through the activity from finish to start.

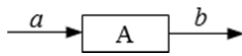

Fig. 4 Normal critical activity

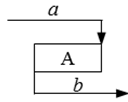
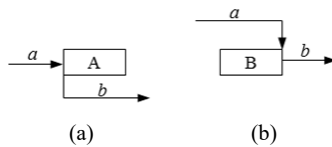

Fig. 5 Reverse critical activity

- 3) *Neutral (U)*: denotes an activity that its length is independent of the project duration. There are two types of *neutral* critical activities. (a) *Start-neutral (SU)*: if a critical path enters and exits from the starting point of an activity, then the activity is called *start-neutral* critical. (b) *Finish-neutral (FU)*: if a critical path enters and exits from the ending point of an activity, then the activity is called *finish-neutral* critical. Fig. 6 shows the *start-neutral* and *finish-neutral* critical activities.

Fig. 6 (a) *Start-neutral* critical activity, (b) *finish-neutral* critical activity

B. Activity on Multi-Critical Path

If multi-critical path passes through an activity, then the effect of activity on project duration would be dependent on the type of combination of paths. Although, Wiest [3] have stated the effect of critical activity when it is located on more than one critical path, all the statements are not true. For example, as Wiest [3] mentioned, the combination of *neutral* and *reverse* will result *reverse*. However, in the following, we will show that it would have a different result.

- 1) *Perverse (P)*: denotes an activity which is provided by the combination of *reverse* and *normal* critical paths. Whether the duration of a *perverse* critical activity is shortened or lengthened, the project duration will be increased. Fig. 7 depicts a *perverse* critical activity, in which the critical path ab (*reverse* path) enters and exits from the finish to start of activity A, while the critical path cd (*normal* path) enters and exits from the start to finish of the activity. Shortening activity A in Fig. 7 will decrease path cd , but increase path ab . And lengthening it will decrease path ab , but increase path cd . Therefore, whether activity A is shortened or lengthened, at least one path will increase, and hence, the project duration will also increase.
- 2) *Decrease-reverse (DR)*: the combination of *neutral (start-neutral or finish-neutral)* and *reverse* will result in a *decrease-reverse* effect on the project duration.

Shortening a *decrease-reverse* activity will increase the project duration, but lengthening it will have no effect on project duration. For example, shortening activity A in Fig. 8 will increase the path ab , but have no effect on path cb . Then, the project duration will increase because the path ab , which would be the longest path, will determine the project duration. Lengthening this activity will decrease path ab , but have no effect on path cb . So, the project duration will not be changed. Because path cb would be the longest path and it will determine the project duration.

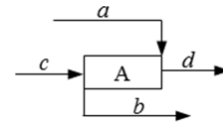
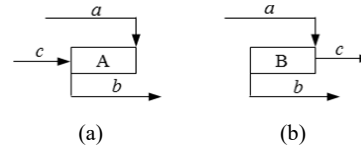

Fig. 7 Perverse critical activity

Fig. 8 (a) *Start-decrease-reverse* critical activity, (b) *finish-decrease-reverse* critical activity

- 3) *Increase-normal (IN)*: the combination of *neutral (start-neutral or finish-neutral)* and *normal* will result *increase-normal* effect on project duration. Lengthening an *increase-normal* activity will increase the project duration, but shortening it will have no effect on project duration. For example, lengthening activity A in Fig. 9 will increase the path ac , but have no effect on path ab . Then, the project duration will increase. Shortening the activity will decrease the path ac , but have no effect on path ab . Therefore, the project duration will not be changed.

V. DETERMINING FLOAT FOR CRITICAL ACTIVITIES

A. Float for Non-Critical Activity

Before identifying the float for critical activity in PDM, it is needed to have an observation on traditional definition of float. An activity with positive float is called as non-critical activity. A non-critical activity may have several types of floats i.e., total float (TF), free float (FF), and independent float (IF). Each type of float gives us important information about the characteristic and the flexibility of activity. TF is the maximum amount of time an activity can be delayed from its early start without delaying the entire project. FF is defined as the maximum amount of time an activity can be delayed without delaying the early start of the succeeding activities. Since FF is a part of TF, it is always true that $TF \geq FF$. Independent float is defined as the maximum amount of time for which an activity can be postponed without affecting the early start of the succeeding activities and without being affected by the allowable delay of the preceding activities [7].

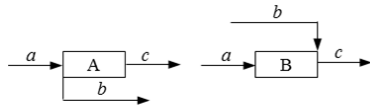

Fig. 9 Increase-normal critical activities

So far, all floats are associated with non-critical activity. In this study, we introduce some new types of float associated with critical activity. These floats would concretely define the characteristic of a critical activity in a PDM network.

B. Float for Critical Activity

An activity with zero TF is denoted as critical activity. Obviously if TF of an activity is zero, then its FF and IF will be also zero. Because FF and IF are the parts of TF [6]. However, a critical activity in PDM may have several types of floats other than TF, FF, and IF.

1. Reverse float (RF): it is the maximum amount of time associated with a reverse critical activity that when the length of an activity is extended, then the critical path will be decreased. After consuming the entire reverse float, the activity effect will be changed to decrease-critical. For example, lengthening activity 4 (which is a reverse critical activity) in Fig. 3 by 1 day will shorten the project duration from 15 days to 14 days. Afterward, lengthening it would no longer have any effect on project duration, and it would be changed to decrease reverse activity. Therefore, this activity has 1 day reverse float. The reverse float is calculated from the following equation.

$$RF_R = \min \begin{cases} ES_R - EF_i - l_{iR}, \forall FS_{iR} \\ ES_R - ES_i - l_{iR}, \forall SS_{iR} \\ LS_j - EF_R - l_{Rj}, \forall FS_{Rj} \\ LF_j - EF_R - l_{Rj}, \forall FF_{Rj} \end{cases} \quad (1)$$

where, R is the reverse critical activity, RF_R is reverse float of activity R , i is the predecessor activity, and j is the successor activity.

2. Neutral float (UF): it is the maximum amount of time associated with neutral critical activity by which the length of an activity can be extended without affecting the duration of a critical path. After use of all the neutral float, the activity effect will be changed to normal critical. For example, activity 5 in Fig. 3 is neutral critical, so that lengthening it by 2 days will have no effect on project duration. But, lengthening it by more than 2 days will increase the project duration. Thus, activity 6 has 2 days of UF. The UF is calculated from (2) and (3) for start-neutral critical activity:

$$UF_U = \min \begin{cases} LS_j - EF_U - l_{Uj}, \forall FS_{Uj} \\ LF_j - EF_U - l_{Uj}, \forall FF_{Uj} \end{cases} \quad (2)$$

For finish-neutral critical activity:

$$UF_U = \min \begin{cases} ES_U - EF_i - l_{iU}, \forall FS_{iU} \\ ES_U - ES_i - l_{iU}, \forall SS_{iU} \end{cases} \quad (3)$$

where, U is the neutral critical activity and UF_U is the neutral

float of activity U .

3. Decrease-reverse float (DF): it is the maximum amount of time associated with decrease-reverse critical activity by which lengthening the activity would not effect on project duration. After consumption of DF, the activity effect will be changed to perverse critical. For example, let us consider the simple schedule network in Fig. 10, in which activity 3 is a decrease-reverse critical. When the duration of activity 3 is lengthened by 2 days, it would have no effect on project duration. But, if it is lengthened by 3 days (or more than 2 days), then the project duration will be increased. Thus, activity 3 in Fig. 10 has 2 days DF. The DF is calculated from (4) and (5).

For start-decrease-reverse critical activity:

$$DF_D = \min \begin{cases} LS_j - EF_D - l_{Dj}, \forall FS_{Dj} \\ LF_j - EF_D - l_{Dj}, \forall FF_{Dj} \end{cases} \quad (4)$$

For finish-decrease-reverse critical activity:

$$DF_D = \min \begin{cases} ES_D - EF_i - l_{iD}, \forall FS_{iD} \\ ES_D - ES_i - l_{iD}, \forall SS_{iD} \end{cases} \quad (5)$$

where, D is the decrease-reverse critical activity and DF_D is decrease-reverse float of activity D .

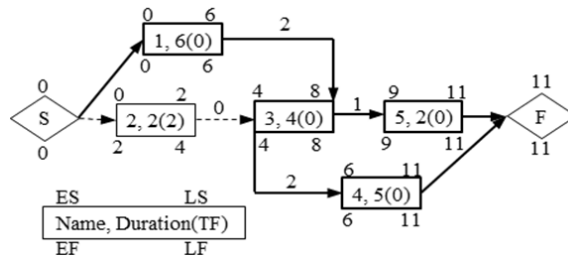

Fig. 10 Activity 3 has 2 days DF

VI. CASE STUDY

To better illustrate the critical activity classification and identify the proposed floats for each class, we use a slightly more complicated example which is taken from the text of Wiest and Levy [4]. It is assumed that there is construction of a large condominium project, in which a number of essentially identical housing units are built sequentially. The example follows three units only and is concerned with just the laying of cement slabs. Performing the laying of cement slabs for each unit is broken down into 5 activities as follows.

- 1) Clear lot and grade 8 hours
- 2) Place concrete forms 12 hours
- 3) Lay sewer lines 16 hours
- 4) Install reinforcement steel 9 hours
- 5) Pour concrete and smooth 4 hours

The total number of activities that must be performed for 3 units is 15 activities. These activities are numbered sequentially, unit by unit as: activities 1 through 5 refer to unit 1, activities 6 through 10 refer to unit 2, and activity 11 through activity 15 refer to unit 3. For example, activity 2 is

“Place concrete forms, unit 2” and activity 14 is “Install reinforcement steel, unit 3.” The example data with proper precedence relationships are shown in Table I. Fig. 11 represents the schedule network which is drawn on Activity-On-Arrow fashion, with precedence arrows connecting the activities at the appropriate ends (start or finish). The time lag factor (l_{ij}) is inside the box attached to arrows. Using the forward and backward calculations of the PDM algorithm, as shown in Table II, we calculated the *ES*, *EF*, *LS*, *LF*, *TF*, and the project duration. The project duration is 56 working hours. We can observe the critical activities (activity with zero *TF*) in Table II as activities 1, 2, 3, 7, 8, 12, 13, 14, and 15. These activities are denoted by bold numbers in Table II. Also, we identified 3 following critical paths in Fig. 11: (1) the sequences activities of 1, 3, 8, 13, 12, 14, and 15 connecting by precedence relationships of $FS_{1,3}$, $SS_{3,8}$, $SS_{8,13}$, $FF_{13,12}$, $SS_{12,14}$, $FS_{14,15}$; (2) the sequences activities of 1, 3, 2, 7, 12, 14, and 15 connecting by precedence relationships of $FS_{1,3}$, $FF_{3,2}$, $SS_{2,7}$, $SS_{7,12}$, $SS_{12,14}$, $FS_{14,15}$; and (3) the sequences activities of 1, 3, 7, 12, 14, and 15 connecting by precedence relationships of $FS_{1,3}$, $SS_{3,8}$, $FF_{8,7}$, $SS_{7,12}$, $SS_{12,14}$, $FS_{14,15}$. The duration of critical path in PDM will be calculated from:

$$d_{p_i} = \sum d_{N_i} + \sum l_{ij} - \sum d_{R_i} \quad (6)$$

where, d_{p_i} is the duration of path, d_{N_i} the duration of normal activity, l_{ij} is the duration lag factor, and d_{R_i} is the duration of

reverse activity.

TABLE I
ACTIVITY INFORMATION FOR LAYING CEMENT SLABS

Activity	Description	Duration	Precedence Relationship
1	Clear & Grade 1	8	
2	Con. Forms 1	12	1 FS, 3 FF=2
3	Sewer Lines 1	16	1 FS
4	Reinforcement 1	9	2 FF=1 & SS=7, 3 SS=7
5	Pour Concrete 1	4	4 FS=2
6	Clear & Grade 2	8	1 FS
7	Con. Forms 2	12	2 SS=10, 6 FS, 8 FF & SS=7
8	Sewer Lines 2	16	3 SS=10, 6 FS
9	Reinforcement 2	9	4 FS, 7 SS=7 & FF=1, 8 SS=7 & FF
10	Pour Concrete 2	4	5 SS=2, 9 FS=2
11	Clear & Grade 3	8	6 FS
12	Con. Forms 3	12	7 SS=10, 11 FS, 13 FF=2
13	Sewer Lines 3	16	8 SS=10, 11 FS
14	Reinforcement 3	9	9 FS, 12 SS=7 & FF=1, 13 SS=7 & FF
15	Pour Concrete 3	4	10 SS=2, 14 FS=2

For example, the duration of critical path 1 is calculated as:

$$\begin{aligned} \sum d_{N_i} &= (d_1 + d_{13} + d_{14} + d_{15}) = 37 \\ \sum l_{ij} &= (l_{3,8} + l_{8,13} + l_{13,12} + l_{12,14} + l_{14,15}) = 31 \\ \sum d_{R_i} &= (d_{12}) = 12 \\ d_{p_1} &= 37 + 31 - 12 = 56 \end{aligned}$$

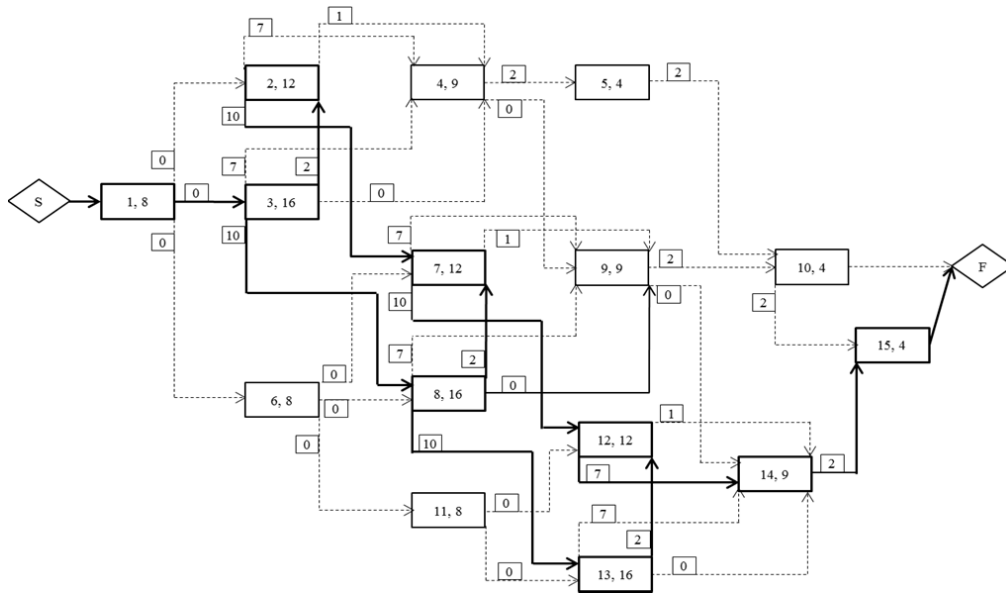

Fig. 11 PDM schedule network of laying cement slabs

An observation should be noted about activity 12 in Fig. 11. The activity 12 has a reverse effect on critical path 1, and it has a neutral effect on critical path 2 and 3 critical path. However, it would have decrease-reverse effect on project duration.

As shown in Fig. 11, the critical paths (the sequences of critical activities and critical precedence arrows) are

highlighted by a bold line. We classify the critical activity effect as follows: activity 1, activity 13, and activity 15 are normal (*N*); activity 2 is reverse (*R*); activity 14 is start-neutral (*SU*); activity 7 is decrease-reverse (*DR*); and activity 3, activity 8, and activity 12 are increase-normal (*IN*). Using the proposed (1)-(5) described earlier, we provided floats for critical activities i.e., *RF*, *NF*, and *DF*, in column 7 to column

9 of Table II.

TABLE II
SCHEDULE RESULT OF LAYING CEMENT SLABS

Activity	ES	EF	LS	LF	TF	RF	UF	DF	Class
1	0	8	0	8	0	-	-	-	N
2	14	26	14	26	0	3	-	-	R
3	8	24	8	24	0	-	-	-	IN
4	21	30	23	32	2	-	-	-	-
5	32	36	44	48	12	-	-	-	-
6	8	16	10	18	2	-	-	-	-
7	24	36	24	36	0	-	-	3	DR
8	18	34	18	34	0	-	-	-	IN
9	31	40	32	41	1	-	-	-	-
10	42	46	50	54	8	-	-	-	-
11	16	24	20	28	4	-	-	-	-
12	34	46	34	46	0	-	-	3	DR
13	28	44	28	44	0	-	-	-	N
14	41	50	41	50	0	-	-	-	N
15	52	56	52	56	0	-	-	-	N

VII. CONCLUSION

Traditional CPM scheduling technique is essentially limited to finish-to-start (FS) relationships between activities, i.e., the successor activity cannot start until the predecessor activity is completed. Therefore, it could not allow overlapping unless activities were further divided. PDM, which was developed based on the concept of CPM analysis, introduced three alternative relationships, i.e., start-to-start (SS), finish-to-finish (FF), and start-to-finish; and lag factor between various activities. The PDM provides a more flexible realistic project representation in schedule networks and more accurately reflects the sequence of construction operations as they occur in real life. There are various computer software packages available such as Primavera P6 and MS Project, which provide the PDM schedule network. However, the new relationships of PDM can change some of the basic concepts of critical activities and critical path. According to the basic definition of critical activity in CPM, the shortening/lengthening of a critical activity on critical path always results in decreased/increased project duration. But, this definition does not always apply on PDM. Changing the duration of some critical activities in PDM can have anomalous effects.

In this paper, we did further research on the classification of critical activity effects, which are proposed by previous researchers, and introduced new floats for each class of critical activities in the PDM schedule. Thus, project managers will clearly distinguish the behavior of each critical activity on a critical path, and they can change the project duration by shortening/lengthening activities based on the project budget and the project deadline.

REFERENCES

- [1] H. N. Ahuja, *Project Management-Techniques in Planning and Controlling Construction Project*, 2nd ed., John Wiley & Sons, New York, 1994.
- [2] J. W. Fondahl, "A non-computer approach to the critical path method for the construction industry," *J. Constr. Eng. Manage.*, vol. 132 no. 7, pp. 697-711, 1961.
- [3] J. D. Wiest, "Precedence diagramming method: Some unusual characteristics and their implications for project managers," *J. of Operations Manage.*, vol. 1, no. 3, pp. 121-130, Feb. 1981.
- [4] D. J. Wiest and K. F. Levy, *A Management Guide to PERT/CPM with GERT/DCPM and other Networks*, 2nd ed., Prentice-Hall, Inc., USA, 1977.
- [5] M. Lu and H. C. Lam, "Transform Schemes Applied on Non-Finish-to-Start Logical Relationships in Project Network Diagrams," *J. Constr. Eng. Manage.*, vol. 135, no. 9, pp. 863-873, Sep., 2009.
- [6] J.J. Moder, C.R. Phillips and E.W. Davis, *Project Management with CPM, PERT and Precedence Diagramming*, 3th ed., Van Nostrand Reinhold, USA, 1983.
- [7] S. Mubarak, *Construction project Scheduling and Control*, 2nd ed., John Wiley & Sons, Canada, 2008.