

Multi-Criteria Selection and Improvement of Effective Design for Generating Power from Sea Waves

Khaled M. Khader, Mamdouh I. Elimy, Omayma A. Nada

Abstract—Sustainable development is the nominal goal of most countries at present. In general, fossil fuels are the development mainstay of most world countries. Regrettably, the fossil fuel consumption rate is very high, and the world is facing the problem of conventional fuels depletion soon. In addition, there are many problems of environmental pollution resulting from the emission of harmful gases and vapors during fuel burning. Thus, clean, renewable energy became the main concern of most countries for filling the gap between available energy resources and their growing needs. There are many renewable energy sources such as wind, solar and wave energy. Energy can be obtained from the motion of sea waves almost all the time. However, power generation from solar or wind energy is highly restricted to sunny periods or the availability of suitable wind speeds. Moreover, energy produced from sea wave motion is one of the cheapest types of clean energy. In addition, renewable energy usage of sea waves guarantees safe environmental conditions. Cheap electricity can be generated from wave energy using different systems such as oscillating bodies' system, pendulum gate system, ocean wave dragon system and oscillating water column device. In this paper, a multi-criteria model has been developed using Analytic Hierarchy Process (AHP) to support the decision of selecting the most effective system for generating power from sea waves. This paper provides a widespread overview of the different design alternatives for sea wave energy converter systems. The considered design alternatives have been evaluated using the developed AHP model. The multi-criteria assessment reveals that the off-shore Oscillating Water Column (OWC) system is the most appropriate system for generating power from sea waves. The OWC system consists of a suitable hollow chamber at the shore which is completely closed except at its base which has an open area for gathering moving sea waves. Sea wave's motion pushes the air up and down passing through a suitable well turbine for generating power. Improving the power generation capability of the OWC system is one of the main objectives of this research. After investigating the effect of some design modifications, it has been concluded that selecting the appropriate settings of some effective design parameters such as the number of layers of Wells turbine fans and the intermediate distance between the fans can result in

significant improvements. Moreover, simple dynamic analysis of the Wells turbine is introduced. Furthermore, this paper strives for comparing the theoretical and experimental results of the built experimental prototype.

Keywords—Renewable energy, oscillating water column, multi-criteria selection, wells turbine.

I. INTRODUCTION

SUSTAINABLE development has become a major concern of most countries in recent years. Generally, fossil fuel is the main pillar of industrial development. Furthermore, the availability of fossil fuels with sufficient quantities is one of the important factors that help industrial countries in developing their industrial sectors at a rapid pace.

Unfortunately, the fossil fuel consumption rate is very high and does not match with the rate of increasing energy demand in these countries. Also, toxic and harmful emission fumes during conventional fuel burning can be considered as a serious environmental pollution problem [1]. Such serious environmental problems hinder progress efforts in industrial countries. Thus, clean renewable energy has attracted the attention of industrial countries in recent times for compensating the energy shortage in addition to preserving the environment [2], [3]. Clearly, reliance on renewable energy can solve the energy shortages problem but developing its usage needs enough time to meet the future tasks. Some regions around the world are somewhat modest in their resources of traditional energies such as; oil, coal and natural gas. Hence, exploiting additional energy recurses other than fossil fuel must be the main task of these regions for guaranteeing the sustainability of available energy sources for a long time. Thus, regions with poor traditional energies can use many types of clean renewable energy resources such as wind, solar and sea waves for treating their energy shortage. However, the usage percentage of various types of renewable energy is still low. Whereas, consumed renewable energy such as solar, wind, hydro and sea waves is still around 10% from the total energy across the world over the past few years [4].

It is encouraging to note that, some regions in the Middle East, such as the Gaza Strip, are trying to do their best to fill the gap between their available energy and their growing needs using renewable energy, as in [5]. Also, the consumption percentage of renewable energy in Egypt is around 11% from the total energy usage in the last five years. Furthermore, the Egyptian authorities suggested an ambitious

Khaled M. Khader is member of the teaching staff and Responsible as chairman of the Department of Production Engineering & Mechanical Design, Faculty of Engineering, University of Menoufia, Shebin El-kom, Menoufia, Egypt (phone: 00201223538574, fax 0020482235695, e-mail: khkhm62@hotmail.com).

Mamdouh I. Elimy is member of the teaching staff with the Department of Production Engineering & Mechanical Design, Faculty of Engineering, University of Menoufia, Shebin El-kom, Menoufia, Egypt, Also, he has contract for teaching in the Northern Border University in Saudi Arabia (corresponding author, phone: 00966590806923, fax 0020482235695, e-mail: mamdoughelimi@yahoo.com).

Omayama A. Nada is member of the teaching staff with the Department of Production Engineering & Mechanical Design, Faculty of Engineering, University of Menoufia, Shebin El-kom, Menoufia, Egypt (phone: 00201064695475, fax 0020482235695, e-mail: onada2000@yahoo.com).

plan to reach a usage percentage 20% of renewable energy from the total energy usage by 2020, as in [6].

Generally, solar energy is only available in the sunny time during the day which does not exceed one-third of total daytime. Hence, the performance of solar cells may fluctuate through the day and during different seasons. Likewise, the active strong wind energy does not steadily exist during the whole day and seasons. Thus, it is impossible to maintain the performance of wind turbines at a constant level. Also, the capability of generating energy from water cliffs on rivers is not available for most countries in the world. In addition, there serious risks that may occur during the power generation process in power plants using nuclear power [7]. On the other hand, generating energy from sea waves is available during most of day-time and throughout the year. Hence, the process of electricity generation from seas waves is considered to be more effective than generation from wind or solar sources. Generally, seas and oceans can be used for generating electricity by many ways such as the use of tidal energy, kinetic energy of moving waves, in addition to usage of temperature variation between warm water content at the surface and cold water near the seabed [4].

There are many alternate ideas dealing with generating power from sea waves, as presented in [8]. Moreover, a prototype of mechanical mechanism which can be used for generating power from sea wave's motion is introduced in [9]. Furthermore, a special technique for converting sea wave's energy to electricity is presented in [3] that deals with the shoaling phenomenon near coasts.

The systems which generate power from sea wave's motion are depending on many operating ideas as; Oscillating Bodies (OB) system, Wave Dragon (WD) system, Pelamis Converter (PC) system, Pendulum Gate (PG) system, Power Buoy (PB) system, Bristol Cylinder (BC) system, Over-Topping Converter (OTC) system and OWC system, as discussed in [10]-[16].

OB system has an immersed oscillating cylinder composed of two parts, the bottom one is fixed with the seabed and the upper part is floating part that can move according to sea wave's motion within the other part through a smooth guide causing relative motion between the two parts that can be transformed into power as indicated in [10]-[12]. WD system consists of two large upward paths that collecting the water of moving waves in huge reservoir which has a foundation in the seabed. This reservoir is provided with a hydro turbine in its base. The passing water inside the turbine generates the rotation motion in turbine's rotor. The PC system consists of a set of semi-submerged cylinders in shallow water. These cylinders are connected to each other by joints. The wave's motion generates a relative motion between these floating cylinders to generate energy by pumping high pressure fluid to activate hydraulic motors connected with a generator, as presented in [13].

PG system is an oscillating gate that has a pendulum motion resulting from wave's motion near coasts. This oscillating motion can be converted to electricity via a suitable generator. The PB system utilizes the rising and falling effect resulting

from the wave's motion which moves the buoy for producing mechanical energy to generate electricity. This electrical power can be transmitted to the coast via undersea secure cables. On the other hand, the BC system in shallow water has a floating cylinder connected to a gearbox via two sets of four bars and joints. This gearbox is fixed to the seabed. Up and down motion of the floating cylinder results in a partially rotary motion in the joints which can be transmitted to the gearbox. This motion can activate the connected generator for generating electricity as mentioned in [13]. OTC system is similar to WD system but it has a submerged reservoir connected with the seabed via strong springs allowing the up and down water motion to its reservoir. There is a turbine in the bottom of this reservoir for generating electricity, as presented in [14].

OWC can be constructed at the shore. It consists of a suitable hollow chamber which is completely closed except at the base that is used for collecting moving water from waves using an inclined entrance beside the breakwater. Sea wave's motion pushes the air pocket inside the chamber up and down passing through an appropriate turbine or driving a suitable mechanical system in order to generate electricity, as mentioned in [9], [15]-[18].

The pushed air of the OWC in the chamber passes inside a suitable turbine such as the Wells turbine which can be fixed beside the chamber. Moreover, the drawn air passes through turbine in opposite direction as a suction effect during wave's water returns back to sea. Consequently, the used turbine with OWC must be designed to continually rotate in the same direction regardless of the air flow direction. Thus, Wells turbine is the best selection for this job, where it can rotate continuously in the same direction as mentioned in [8], [19], [20].

Clearly, establishing different systems inside the oceans and seas for generating power must have high endurance and long life time. Through the recent decades, there are many strenuous trials done for designing effective energy converters for generating electricity from oceans and sea waves. But unfortunately, many of these trials have failed because of the harsh operating conditions in seas and oceans in addition to aggressive salty water. For this reason, many researchers do not agree up till now on the definite economical designs of devices which can be used to generate power from oceans and sea waves, regardless of the extensive research in this field [21].

Currently, several systems for converting wave power into electrical power have been discussed to be considered for application. Each of these systems has its advantages and disadvantages. The selection of the most appropriate system for application is a critical decision in the planning phase of power generation projects. In this research, the characteristics for each method have been investigated and the main criteria for assessment of these methods have been highlighted. A multi-criteria model has been developed to support the decision making process concerning the selection of the most appropriate method according to the designer's preferences. The model is developed using AHP. Besides, the application

of the multi-criteria selection model revealed that the OWC system is the most preferable system for generating electricity from oceans and sea waves based on the assessment criteria considered in the model. Furthermore, analysis of OWC system is presented in this research for generating electricity from moving waves of seas and oceans using a Wells turbine. A suitable small prototype is designed and introduced for testing the effective parameters which can enhance the OWC system performance.

II. MULTI-CRITERIA SELECTION MODEL

Multi criteria decision making (MCDM) approaches are extensively applied in several fields including renewable energy planning. A comprehensive review of the application of MCDM tools in the field of sustainable energy planning is presented in [22]-[24]. One of the most powerful MCDM techniques is the AHP [25]. AHP is a systematic procedure for dealing with complex decisions, it encompasses evaluating alternatives with respect to sets of criteria that could be a mix of tangible and intangible ones to support rational decision making. The application of AHP necessitates the decomposition of all the significant factors affecting the decision maker's goal into criteria and subcriteria and constructing a hierarchical structure for the decision under consideration. AHP mainly uses pairwise comparisons, where each element in a higher layer is used to assess the elements in the layer immediately below in order to derive relative importance or weight of lower layer elements with respect to the element in the upper layer. These comparisons can be performed by the decision maker or by a group of experts using not only data available but also using human judgment. After performing these comparisons across the different layers of the hierarchy, weights are then synthesized through the model, yielding a composite rank or priority for each choice at every layer in addition to an overall ranking.

In this section, an AHP model is developed to aid the designer in comparing and ranking the eight design alternatives explained earlier, as well as selecting the best design according to the provided preferences.

A. Design Selection Criteria and Decision Hierarchy

In this research, the decision concerned with selecting the most appropriate design idea for power generation from sea waves is structured, as illustrated in Fig. 1. In this model, seven main criteria have been considered for assessing the design alternatives, namely, reliability, safety, performance, durability, serviceability, cost, and interference with navigation. In this model, reliability reflects the probability of a system malfunctions or fails within a specified time period and it can be assessed based on judgments of the mean time between failures, or the failure rate [26]. Safety is considered for assessing predictable hazards associated with the power system surroundings or working conditions. Likewise, as defined in [26], durability measures the expected useful life of a system. It can be estimated based on the amount of use one can expect to get from a system before it breaks down and its replacement becomes preferable than continued repair. In the

meanwhile, serviceability is assessed through ease of maintenance as well as speed of repair.

The performance criterion is decomposed into four different subcriteria. It comprises efficiency, possibility of power storage, power quality which refers to the stability and smoothness of the generated power, in addition to robustness. In this context, robustness appraises the system's sensitivity to external environmental factors as well as survival under sever conditions. Furthermore, cost is evaluated based on installation cost along with maintenance and operational costs. As a final point, interference with navigation is considered to assess the effect of power generating systems on marine life, as some designs could result in electromagnetic fields created due to the use of electric cables connected to the turbines and underwater noises, in addition to vibrations that could affect orientation and navigational ability. The lower layer of the model contains the considered eight system design alternatives, namely, BC, OB, OWC, OTC, PC, PG, PB, and WD. The hierarchical structure of the system design selection AHP model is shown in Fig. 1.

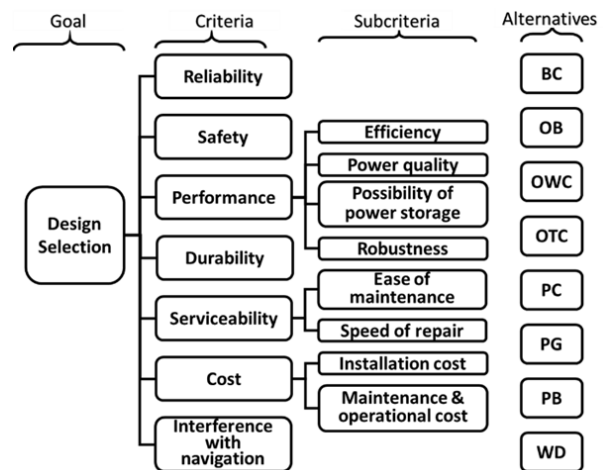

Fig. 1 Hierarchical structure of the design selection AHP model

B. Pairwise Comparison Matrices

AHP mainly depends on pairwise comparisons. To construct a pairwise comparison matrix A for n criteria, one should start with a square matrix $n \times n$. An assessment system based on Satty's scale (ranges from 1 to 9), [25] is employed to indicate how much one criterion is more important than another. The entries in such a matrix are represented by $a_{ij} > 0$, where;

$$a_{ij} = \begin{cases} 1 & , \quad i = j \\ 1/a_{ji} & , \quad i \neq j \end{cases} \quad (1)$$

Pairwise comparison matrices are reciprocal matrices. Therefore, the number of comparisons or judgments needed for each matrix with n criteria is $n(n-1)/2$. In this research, the Super Decisions Software [27] is used to construct the model and to perform the required calculations for the AHP

application. After constructing any pairwise comparison matrix, it should be checked for inconsistency. The inconsistency can be assessed as recommended in [28]. It has been also recommended that the inconsistency ratio should not exceed 0.10. If it is more, the comparison matrix is considered inconsistent and judgments should be reviewed and improved.

In the hierarchal structure presented in the previous section, four main criteria are connected directly to the alternatives. These are durability, reliability, safety, and interference with navigation. The other three main criteria (performance, serviceability, and cost) are connected to eight subcriteria (efficiency, possibility of power storage, power quality, robustness, ease of maintenance, speed of repair, installation cost, as well as maintenance and operational costs) that are then connected to the alternatives. The lowest level criteria or subcriteria connected to the alternatives are called covering criteria. In this model, there are 12 covering criteria. To perform the pairwise comparisons, 16 comparison matrices should be constructed as follows: One matrix for the seven main criteria with respect to the goal as illustrated in Table I; three matrices for the subcriteria under (performance, serviceability, and cost); and 12 comparison matrices for the

eight alternatives with respect to all the covering criteria. The comparison matrix for the four subcriteria under performance (efficiency, possibility of power storage, power quality, and robustness) is shown in Table II.

Meanwhile, the comparison matrix for the two subcriteria under serviceability (ease of maintenance, and speed of repair) is shown Table III. For the two subcriteria under cost, equal preferences have been assigned. Table IV represents a sample of the 12 comparison matrices that assess the eight alternatives with respect to each covering criteria. The sample presented in Table IV illustrates the evaluation of alternatives with respect to durability with inconsistency equals 0.026. The values for the inconsistencies for the other pairwise matrices comparing alternatives with respect to the rest of the covering criteria are as follows: For reliability (0.030), for safety (0.028), and interference with navigation (0.027), for efficiency (0.015), for possibility of power storage (0.023), for power quality (0.037), for robustness (0.022), for ease of maintenance (0.018), for speed of repair (0.016), for maintenance and operational costs (0.035), and for installation cost (0.015). In all of the developed pairwise matrices, consistencies are in the acceptable level.

TABLE I
PAIRWISE COMPARISON MATRIX OF THE MAIN CRITERIA WITH RESPECT TO THE GOAL

Inconsistency= 0.0256	Cost	Durability	Interference with navigation	Performance	Reliability	Safety	Serviceability
Cost	1	1/3	4	1/2	1/3	3	1
Durability	3	1	6	2	1	5	3
Interference with navigation	1/4	1/6	1	1/4	1/5	1/2	1/2
Performance	2	1/2	4	1	1/2	4	4
Reliability	3	1	5	2	1	4	4
Safety	1/3	1/5	2	1/4	1/4	1	1
Serviceability	1	1/3	2	1/4	1/4	1	1

TABLE II
PAIRWISE COMPARISON MATRIX FOR THE SUBCRITERIA WITH RESPECT TO PERFORMANCE

Inconsistency=0.0266	Efficiency	Power storage	Power quality	Robustness	Priorities
Efficiency	1	3	2	1/2	0.293
power storage	1/3	1	1/2	1/3	0.107
Power quality	1/2	2	1	1/2	0.185
Robustness	2	3	2	1	0.415

TABLE III
PAIRWISE COMPARISON MATRIX FOR THE SUBCRITERIA WITH RESPECT TO SERVICEABILITY

Inconsistency=0	Ease of maintenance	Speed of repair	Priorities
Ease of maintenance	1	1/2	1/3
Speed of repair	2	1	2/3

TABLE IV
PAIRWISE COMPARISON MATRIX FOR THE ALTERNATIVES WITH RESPECT TO DURABILITY

	BC	OB	OWC	OTC	PC	PG	PB	WD
BC	1	1/2	1/8	1/2	1	1/3	1/2	1/3
OB	2	1	1/4	1	1/2	1/3	1	1/3
OWC	8	4	1	4	6	3	6	3
OTC	2	1	1/4	1	2	1/2	2	1/2
PC	1	2	1/6	1/2	1	1/2	1	1/3
PG	3	3	1/3	2	2	1	3	1/2
PB	2	1	1/6	1/2	1	1/3	1	1/3
WD	3	3	1/3	2	3	2	3	1

C. Deriving Local Priorities

After performing all the required pairwise comparisons and checking their consistencies, the relative weights (local priorities) of the items of each level in the hierarchy with respect to an item in the next higher level are computed according to [28]. The local priorities of the main seven criteria are presented in Fig. 2. However, the local priorities for subcriteria under performance and serviceability are listed in the last column in Table II and Table III, respectively. The subcriteria under cost are having equal local priorities as they have the same preference in the pairwise comparison matrix. Furthermore, the local priorities for the alternatives with respect to all the covering criteria are listed in Table V.

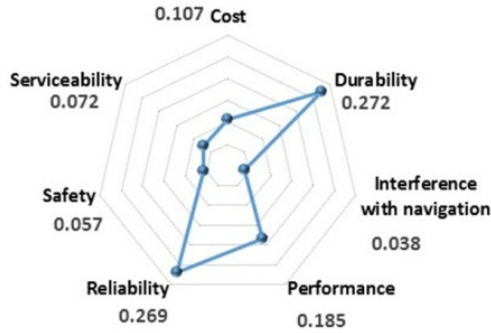

Fig. 2 Derived priorities of the main criteria with respect the goal

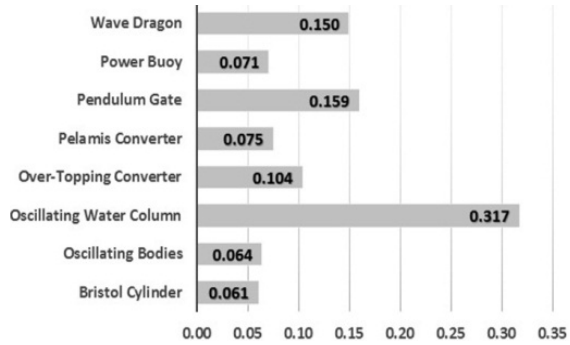

Fig. 3 Alternatives overall priorities

TABLE V
DERIVED PRIORITIES OF THE ALTERNATIVES WITH RESPECT TO EACH COVERING CRITERION

	BC	OB	OWC	OTC	PC	PG	PB	WD
Durability	0.04	0.06	0.36	0.09	0.06	0.14	0.06	0.18
Reliability	0.04	0.05	0.31	0.12	0.09	0.18	0.07	0.14
Safety	0.03	0.06	0.30	0.13	0.09	0.16	0.07	0.17
Interference with navigation	0.21	0.06	0.36	0.03	0.04	0.15	0.06	0.09
Efficiency	0.04	0.07	0.27	0.14	0.09	0.13	0.07	0.20
Power Quality	0.03	0.05	0.18	0.30	0.06	0.09	0.06	0.23
Power storage	0.03	0.10	0.30	0.06	0.08	0.24	0.11	0.07
Robustness	0.20	0.05	0.31	0.09	0.05	0.14	0.06	0.11
Ease of maintenance	0.04	0.08	0.32	0.06	0.08	0.16	0.09	0.16
Speed of Repair	0.04	0.09	0.27	0.06	0.10	0.17	0.10	0.16
Installation Cost	0.04	0.11	0.33	0.06	0.11	0.21	0.10	0.03
Maintenance & Operational Cost	0.05	0.09	0.27	0.09	0.04	0.17	0.10	0.19

D. Model Synthesis (Deriving Overall Priorities)

In order to realize the overall priority for each alternative, composite weights of the decision alternatives can be determined by aggregating the weights throughout the hierarchy. This can be achieved through following a path from the top of the hierarchy to each alternative at the lowest level. Local priorities obtained from the comparisons can be used to weigh the priorities in the level immediately below. This should be done for every item, and then weighed values for each element in the lower level is added. The process of synthesizing through weighing and adding has to be continued until the final priorities of the alternatives in the bottom most level are obtained. The outcome of this synthesis is the overall ranking or priority of the alternatives. The results of model synthesis reveal that systems based on an OWC dominates the other alternatives as it has a relatively higher overall priority than the other alternatives, as illustrated in Fig. 3. The results of the model provide the decision maker with not only the best alternative, but also a ranking of all the alternatives considered in the model.

III. SYSTEM ANALYSIS AND MODELING

A. Propagation of Sea Waves

Wind intensity is not the only effective factor for sea wave's propagation, but there are also other effective factors such as gravity forces and sea surface tension. The propagation of sea waves is shown in Fig. 4.

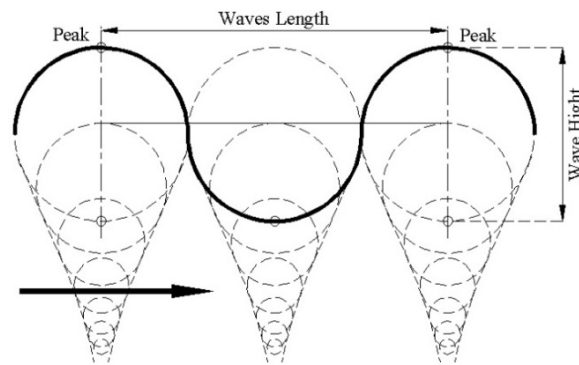

Fig. 4 Propagation of sea waves

Clearly, gradually decreasing diameters of circular trajectories can be formed from water particles as a result of the effective wind in seas and oceans. Note that, the highest diameters are occurring at sea surface and decreasing with depth of water, as mentioned in [8].

The displacement $x(t)$ of the water's surface at a definite point is presented in [29], [30], is as:

$$x(t) = \frac{h}{2} \sin (\omega t - \beta) \tag{2}$$

where, (h) is maximum height of wave which equals to double of its amplitude, (ω) is the wave frequency, (t) is the time, (β) is the phase shift. Moreover, the wave frequency (ω) equals to $(2\pi/T)$, where (T) is the wave period. Furthermore, the volume (V_w) of moving wave can be expressed as presented in [9] as:

$$V_w = \frac{1}{2} h \lambda L \tag{3}$$

where, (λ) is the wave length and (L) is the front wave width.

Also, the sea wave's speed (v_w) can be formulated as:

$$v_w = \frac{\lambda}{T} \quad (4)$$

The kinetic energy (E_w) of sea waves can be expressed as:

$$E_w = \frac{\rho_w}{2} V_w v_w^2 \quad (5)$$

where, (ρ_w) is the density of sea's salty water ($\rho_w=1025 \text{ kg/m}^3$).

B. Sea Waves Power Estimation:

Seas and oceans waves are one of the most important renewable sources of clean energy. Wave power (P_u) over a wave front (L) of unit width which is associated with a wave of maximum height (h) is presented in [9], [12], [17], [31], as:

$$P_u = \frac{\rho_w g^2 h^2 T}{32\pi} \quad (6)$$

where, the gravity acceleration g is equal to 9.81 m/s^2 . Suppose that, the entrance of system chamber is a 10 meter width means that ($L=10 \text{ m}$), as well as one meter maximum height of wave and one second is the period of this wave. Hence, power equals to 9.808 KW can be generated regarding the pervious data. This power can be considered as large power accompanying only 10 meters of moving sea wave over only one second. This rough calculation can strongly encourage developing countries to rely on clean renewable energy from the waves, as this cheap and clean power can fill the gap between available energies and the increasing demand in countries with long shores.

C. Speed of Air Flow Inside OWC Chamber

The OWC is an economical system especially in developing countries, where this system can be established near the sea coast or in shallow water far from the deep water, as shown in Fig. 5. Therefore, establishing these kinds of devices has low establishment and running maintenance costs, in addition to its good environmental impact [32].

The OWC rises in the system chamber with a speed (v_i) as a result of gathering water of volume (V_w) inside it. Increasing volume (V_i) of water column equals ($A_i v_i$), where (A_i) is OWC chamber's cross section area. The increasing water volume (V_i) of OWC equals to the gathered water of volume (V_w), means that ($V_i = V_w$). The pervious relation can be rewritten in the following form:

$$abv_i = 0.5 h \lambda L \quad (7)$$

where (a) and (b) are the internal length and width of cross sectional area of the OWC chamber. Consequently, speed (v_i) is given by:

$$v_i = 0.5 \left(\frac{h \lambda L}{ab} \right) \quad (8)$$

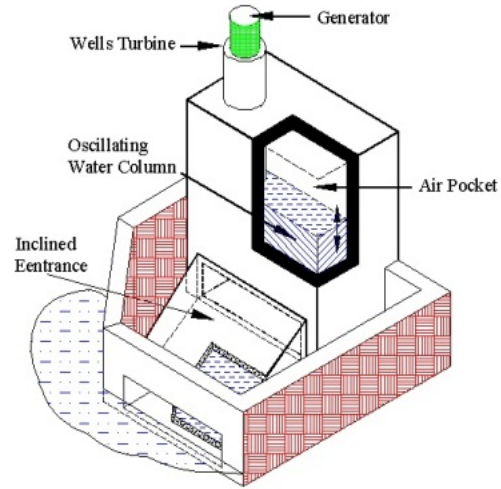

Fig. 5 OWC system

D. Speed of Air Flow inside Wells Turbine

Obviously, OWC in the chamber can move an air pocket above its surface in an upward direction through collecting sea's water inside the OWC chamber. While, OWC can also move the air pocket in the downward direction as a result of the suction effect during the water returning back to sea. Therefore, the Wells turbine, which is shown in Fig. 6, can be considered as the best selection for giving a continuity rotating motion in the same direction regardless of the air flow's direction. But, low efficiency and high noise level are the main Wells turbine disadvantages. Furthermore, previous studies for improving Wells turbine efficiency via selecting its geometrical parameters are presented in [33].

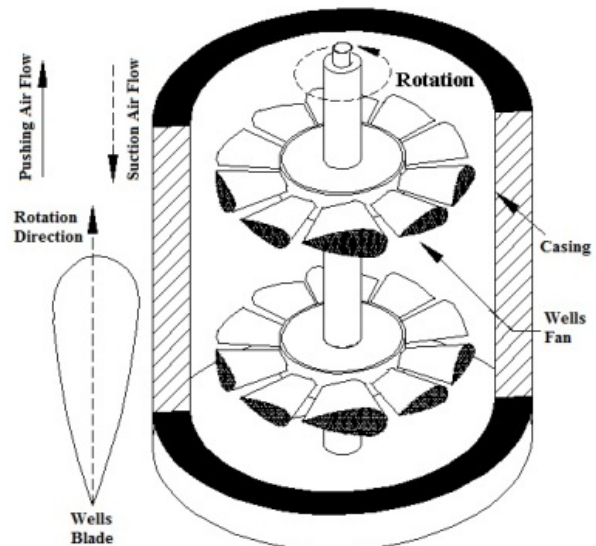

Fig. 6 Wells turbine of two fans

The air volume (V_o) which passes through the Wells turbine of diameter (D_t) is equivalent to the increasing volume (V_i) of OWC, means that ($V_o = V_i$). Hence, the pervious relation can be rewritten as:

$$\frac{\pi}{4} D_t^2 v_o = a b v_i \quad (9)$$

Hence, the speed (v_o) of air passing through turbine can be expressed as:

$$v_o = \frac{4 a b}{\pi D_t^2} v_i \quad (10)$$

The power (P_t) of Wells turbine is depending upon the velocity of air flow, in addition to the effective turbine parameters as in [14], [34]. Generally, the power (P_t) can be given as:

$$P_t = \eta_c \eta_t P^* \quad (11)$$

where, (η_c) is the efficiency of the OWC chamber, (η_t) is the efficiency of the Wells turbine and power P^* is the power which is carried by the sea wave water of volume (V_w). Moreover, sea wave water of volume (V_w) is equivalent to increasing water volume (V_c) of OWC inside its chamber. Furthermore, water volume (V_c) equals to the value of ($ab h_c$). Where, (h_c) is the changing of water column head inside the OWC chamber. Therefore, following formula can be written as:

$$0.5 h \lambda L = a b h_c \quad (12)$$

By assuming that ($\lambda=2\pi h$), the following formula can be written as:

$$h_* = \sqrt{\frac{a b h_c}{\pi}} \quad (13)$$

where, (h_*) is the maximum height of equivalent wave of front water (L) equals one meter. Therefore, power P^* can be given as:

$$P^* = \frac{\rho_w g^2 h_*^2 T}{32 \pi} \quad (14)$$

Furthermore, the flow rate coefficient (ϕ) which is the ratio of axial velocity (v_o) of passing air and rotor tip velocity ($0.5\omega D_t$), where (ω) is angular velocity of Wells turbine's axis. Hence, ϕ can be written as presented in [35], [36] as follows;

$$\phi = \frac{v_o}{0.5 \omega D_t} \quad (15)$$

The angular velocity (ω) can be written as:

$$\omega = \frac{v_o}{0.5 \phi D_t} \quad (16)$$

The relation between Wells turbine efficiency (η_t) and flow rate coefficient (ϕ) of aerodynamic NACA0021 profile which has four blades is presented in [36]. Furthermore, the torque (T_t) at the turbine axis can be given by;

$$T_t = \frac{P^*}{\omega} \quad (17)$$

IV. DYNAMIC ANALYSIS OF WELLS TURBINE

Wells turbine can be considered as a self-rectifying air turbine which is widely used with the OWC system for generating power from seas waves as discussed in [37].

Wells turbine's rotor carries three-dimensional fan's blades which are symmetrical airfoils located around a circular hub. These symmetrical airfoils are oriented with their chord planes perpendicular to rotation's axis as shown in Fig. 7. Many of research work are dealing with starting and running characteristics of Wells turbine considering their blade's shape as in [38].

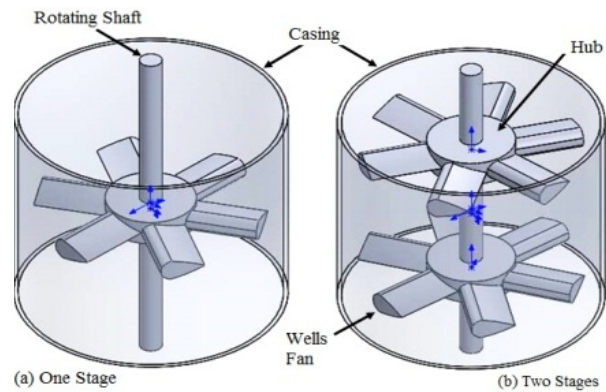

Fig. 7 Outline of Wells turbine

Finite Element (FE) approach can be used for modeling Wells turbine's blades. One fan as one stage of Wells turbine has three interconnected elements with simply supported using two bearing along turbine's shaft. The two fans as two stages have four interconnected elements as shown in Fig. 8, as follows:

Stiffness matrix $[K]$ and mass matrix $[M]$ of the elements can be formulated as follows:

$$[K] = [k]_d + [k]_c \quad (18)$$

$$[M] = [m]_d + [m]_c \quad (19)$$

where, $[m]_d$ is the translational mass matrix, $[m]_c$ is the rotational mass matrix, $[k]_d$ is the stiffness matrix regarding to effects of shaft and blades, in addition to $[k]_c$ is the stiffness

matrix considering the concentrated bearing properties effects. More needed details of forming the pervious matrices are introduced in [39]. Furthermore, Eigen-frequency can be calculated from the solution of the following characteristic equation of the Wells turbine:

$$[-\Omega^2 [M] + K] \{X\} = \{0\} \quad (20)$$

The last equation can be coded in computer program using ANSYS software. The ANSYS software is capable to compute the eigenvalues and eigenvectors for one and two fan stages of the Wells turbine.

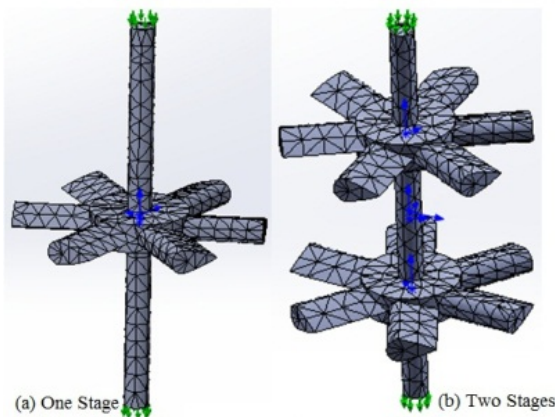

Fig. 8 Wells turbine using Finite Element (FE)

V. EXPERIMENTAL SETUP OF OWC SYSTEM

Some of the previous research works are dealing with improving the OWC systems using experimental studies. These studies are using suitable testing prototypes, as mentioned in [40]-[44].

A. Experimental OWC Prototype

An experimental setup consists of a rectangular glass container. This container includes an oscillating block inside the open part of the container which can move up and down pushing the water to simulate the sea wave motion. Simple prototype design of Wells turbine fixed at the top of this container as shown in Fig. 9.

The constructed experimental setup of the OWC system is shown in Fig. 10. This prototype is built for simulating the sea wave motion in order to generate pushing and suction air motion passing through a Wells turbine. This small OWC system consists of glass container of approximately 80 cm width, 200 cm long and 100 cm depth. This reinforced container has an internal barrier at its middle with an 80 cm depth. This container includes a light oscillating block which can move up and down inside open part of the container to simulate the sea wave motion. Two fans of six blades have an NACA0021 aerodynamic profile fixed in a tube which is mounted over the closed part of the container. The NACA0021 airfoil blade details are introduced in [45].

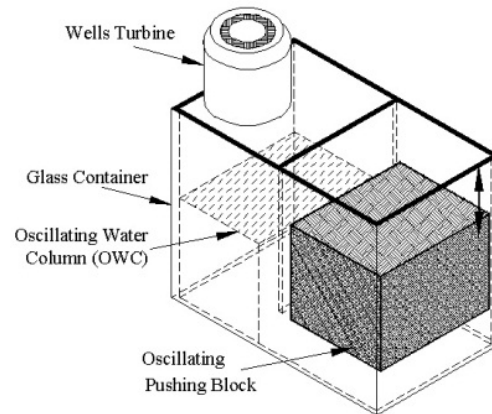

Fig. 9 Experimental setup of OWC system

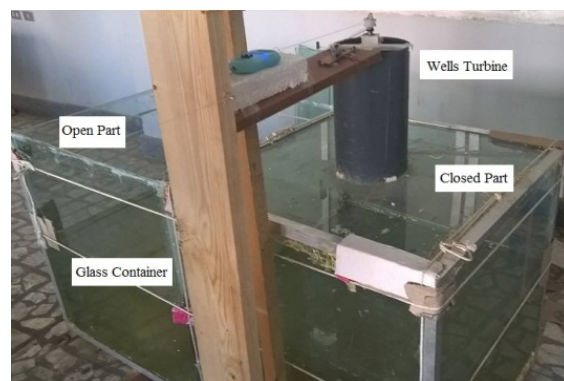

Fig. 10 Small OWC system

The angular rotational speed of Wells fans can be measured using digital laser photo tachometer. Moreover, air flow speed which passing through the Wells turbine can be measured using suitable digital anemometer. Digital laser photo tachometer and digital anemometer are shown in Fig. 11.

The prototype of the Wells turbine can be used for testing the effective values of shift angle (α) and the intermediate distance between the fans stages which improves the Wells turbine performance. The shift angle and the intermediate distance are shown Fig. 12.



Fig. 11 Measuring devices

B. Experimental Modal of Wells Turbine Vibration Analysis

The experimental frequency response tests were accomplished on a Wells turbine prototype by utilizing a suitable dual channel analyzer with fast Fourier Transform (FT) which is connected with computer, as shown in Fig. 13.

The corresponding fundamental frequencies for both one

and two fans stages of the Wells turbine's prototype are measured and recorded through different shift angles. These frequencies are measured at different shift angles using FFT analyzer through the range (800:1600 Hz).

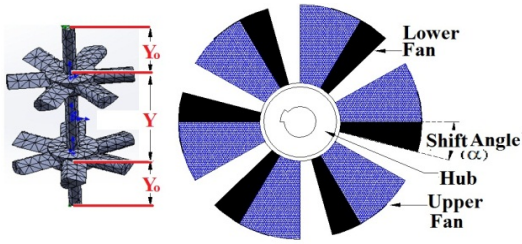

Fig. 12 Shift Angle of stages and intermediate distance of fans



Fig. 13 Duel channel analyzer test

VI. RESULTS AND DISCUSSION

OWC speed (v_i) in a beaker can be calculated through measuring the varying head (h_c) of OWC and its occurrence time.

The following data were used; $\eta_i=58\%$, $\eta_c=80\%$, $g=9.81 \text{ m/s}^2$, $\rho_w=1025 \text{ Kg/m}^3$, $D_f=0.2 \text{ m}$, $a=2 \text{ m}$ and $b=0.8 \text{ m}$. Furthermore, one and two fans stages with six blades of NACA0021 aerodynamic profile are used in the Wells turbine prototype. Thus, the flow rate coefficient (ϕ) equals 0.15 which corresponds ($\eta_i=0.58$) in a relation which is introduced in [36]. Moreover, experimental wind tunnel can be used for simulating air flow of high speeds.

A. Results of OWC System Performance

The relation between theoretical and measured torque to the velocity (v_i) of OWC which rises in the system chamber is shown in Fig. 14. Both of the theoretical and measured torque curves have the same trend approximately. Moreover, the relation between the generated measured powers of Wells turbine to the turbine's rotational speed is shown in Fig. 15. This relation is presented for different shift angles ($\alpha=0^\circ, 15^\circ, 30^\circ$ and 45°) between the upper fan and lower one of the Wells turbine. This relation indicates that the maximum generated power occurs at the shift angle ($\alpha=15^\circ$). Furthermore, the relation between the generated measured powers of the Wells turbine to the turbine's rotational speed dealing with different intermediate distances (Y), as percentage ratios from the whole turbine axis length is shown in Fig. 16. This relation is presented for different percentage ratios of (Y) as; 20%, 30%,

40% and 60%. Also, this relation indicates that the maximum generated power occurs at the intermediate distance (Y) of percentage ratio equals 20%.

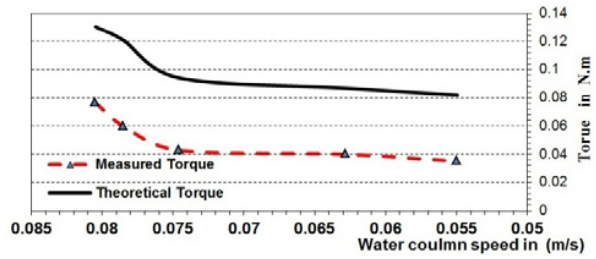

Fig. 14 Theoretical and measured torque using a Wells turbine

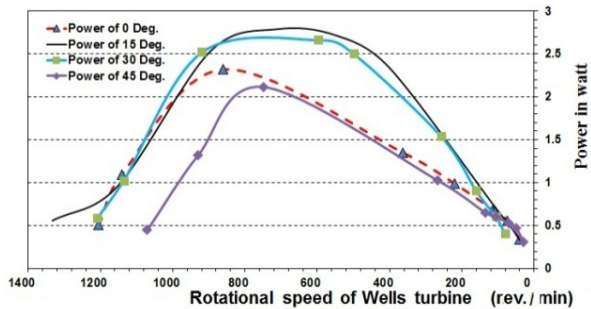

Fig. 15 Effect of shift angle (α) on power of a Wells turbine

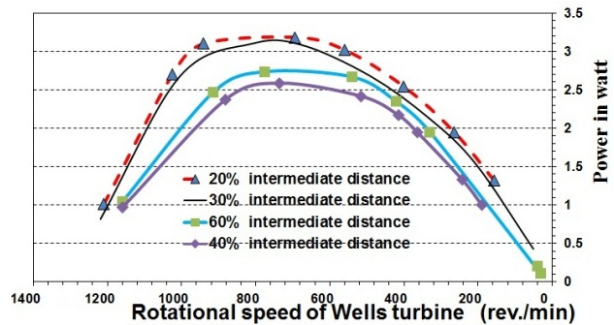

Fig. 16 Effect of intermediate distance (Y) on axis of a Wells turbine

B. Results of Wells Turbine Vibration Analysis

The theoretical natural frequencies of a Wells turbine prototype have been calculated for different fan stages and shift angles between the upper and lower fans. These theoretical frequencies can be calculated using Finite Element Method (FEM). Moreover, the experimental frequencies of the prototype are measured. These frequencies are tabulated in Tables VI and VII with different shift angles ($\alpha=0^\circ, 15^\circ, 30^\circ$ and 45°). Furthermore, these frequencies are shown in Fig. 17.

The results in Tables VI and VII reveal that the natural frequencies of two-stage fans are higher than natural frequencies of one stage at shift angle equals 0° . Moreover, minimum natural frequencies appear at 45° of the two stages. While, maximum ones appear at 0° of two stages.

TABLE VI
THE FIRST FOUR FUNDAMENTAL NATURAL FREQUENCIES (Hz) $\times 10^2$ (NO SHIFT ANGLE)

Mode No.	One fan		Two stages of fans	
	FE	EX	FE	EX
Mode (1)	0.015	0.012	0.019	0.017
Mode (2)	0.024	0.021	0.034	0.029
Mode (3)	0.054	0.050	0.068	0.057
Mode (4)	0.092	0.086	0.096	0.089

TABLE VII
THE FIRST FOUR FUNDAMENTAL NATURAL FREQUENCIES (Hz) $\times 10^2$ (WITH SHIFT ANGLE)

Mode No.	Two stages of fans					
	15°		30°		45°	
	FE	EX	FE	EX	FE	EX
Mode (1)	0.014	0.013	0.01	0.010	0.009	0.007
Mode (2)	0.026	0.024	0.02	0.018	0.016	0.014
Mode (3)	0.053	0.048	0.04	0.035	0.032	0.027
Mode (4)	0.074	0.068	0.06	0.053	0.045	0.043

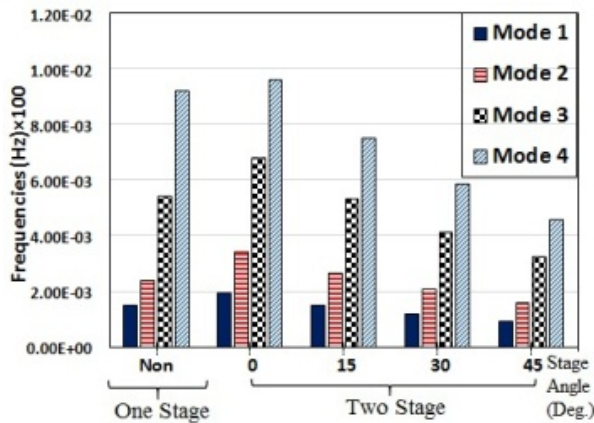

Fig. 17 Relation between natural frequencies and shift angle

VII. CONCLUSION

Clean renewable energy became the main concern of most countries in recent years for filling the gap between existing energy resources and their increasing needs. Moreover, generating energy from the sea's waves can be considered as one of the cheapest and cleanest renewable energy sources. This kind of renewable energy can be obtained from the motion of sea waves almost all the time as opposed to the wind and solar energies which depend only on the availability of appropriate wind speeds and sunny times.

There are many systems that can be used for generating power from the sea wave's energy. To assist the designer in selecting the most appropriate system, this paper proposed a multi-criteria model that has been built using AHP. Furthermore, the application of (AHP) revealed that the OWC system is the most preferable system for generating electricity from oceans and seas waves.

Analyzing and designing experimental prototype is the main concern of this research. This prototype is based on the idea of (OWC) which is more appropriate for implementation in countries with moderate climate conditions like Egypt.

Prototype modeling and experimental setup are used for improving the power generation capability of the OWC system. Power improvement can be achieved via selecting some effective design parameters such as the number of layers of Wells turbine fans and the intermediate distance between the fans. Experimental results revealed that the maximum generated power occurs at the shift angle ($\alpha=15^\circ$). Moreover, maximum generated power occurs at the intermediate distance (Y) of percentage ratio equals 20%.

REFERENCES

- [1] E. Michaelides, *Green Energy and Technology, Alternative Energy Sources*, Springer-Verlag Berlin Heidelberg, Deutschland, 2012, pp.33-63. (online). Available: www.worldenergy.org. (Accessed: 16- Jun- 2017).
- [2] B. Drew, A. Plummer and M. Sahinkaya, "A review of wave energy converter technology", *Journal of Power and Energy*, Proc. IMechE, vol. 223 Part A:JPE782, pp. 887-902, 2009.
- [3] S. Quershi, S. Danish and M. Khalid, "A new method for extracting ocean wave energy utilizing the wave shoaling phenomenon", *International Journal of Scholarly and Scientific Research & Innovation*, vol. 4, no. 12, pp. 667-673, 2010.
- [4] W. Council, *World Energy Council, Energy Resources-2016*, UK, pp.3-6. (online). Available: www.worldenergy.org. (Accessed: 05- Sept- 2017).
- [5] A. Musalam, "Design simulation station to produce electricity and water desalination to solve the problem of shortage of energy and drinking water in the gaza strip", *International Journal of Renewable Energy Research*, vol. 4, no.1, pp. 191-197, 2014.
- [6] I. Abo-Elnga, *New & Renewable Energy Authority in Egypt (NREA)*, Annual Report, Egypt, 2013, pp.12-13. (online). Available: www.nrea.gov.eg/annual%20report/Annual_Report_2012_2013_eng.pdf (Accessed: 10- Aug.- 2017).
- [7] K. Misra, *Handbook of Performability Engineering*, Springer Science & Business Media, London, UK, 2008, pp.1179-1180. (online). Available: <https://books.google.com.eg/books?id=cPgXg3GIMAsC&pg=PA1179&dq=%22#v=onepage&q&f=false>, (Accessed: 12- Jun.- 2017).
- [8] L. Rodrigues, "Wave power conversion systems for electrical energy production", in *Journal of RE&PQJ*, vol. 1, no. 6, p. 601-607, 2008.
- [9] K. Khader, "Power Generation from Sea Waves Using Experimental Prototype of Wells Turbine or Suggested Special Rotating Mechanism", *International Journal of Mining, Metallurgy & Mechanical Engineering (IJMME)*, vol. 3, no. 3, pp. 161-166, 2015.
- [10] J. Falnes, "A review of wave-energy extraction", *Journal of Marine Structures*, vol. 20, pp. 185-201, 2007.
- [11] C. Cargo, A. Plummer, A. Hillis and M. Schlotter, "Determination of optimal parameters for a hydraulic power take-off unit of a wave energy converter in regular waves", *Journal of Power and Energy*, Proc. IMechE, vol. 2263 Part A, pp. 98-111, 2011.
- [12] R. Yeung, A. Peiffer, N. Tom and T. Matlak, "Design, analysis and evaluation of the uc-berkeley wave-energy extractor", in the *29th ASME International Conference on Oceans Offshore and arctic Engineering OMAE210*, Shanghai, China, June 2010, p. 1-11.
- [13] L. Rodrigues, "Devices for sea wave power extraction to electrical energy conversion", *International Journal of Engineering and Industrial Management*, vol. 3, pp. 193-210, 2010.
- [14] A. Muetze and J. Vining, "Ocean wave energy conversion - a survey", in the *Conference of Industry Application IEEE*, Tampa, Florida, October 2006, pp.1410-1417.
- [15] A. Falcao and J. Henriques, "Oscillating-Water-Column Wave Energy Converters and Air Turbines: A review", *International Journal of Renewable Energy*, vol. 3, pp. 1-34, 2015.
- [16] J. Henriques, J. Portillo, L. Gato, R. Gomes, D. Ferreira and A. Falclao, "Design of Oscillating-Water-Column Wave Energy Converters with an Application to Self-Powered Sensor Buoys", *International Journal of Energy*, vol. 112, pp. 852-867, 2016.
- [17] A. Elhanafi, A. Fleming, G. Macfarlane, and Z. Leong, "Numerical Hydrodynamic Analysis of an Offshore Stationary-Floating Oscillating Water Column-Wave Energy Converter Using CFD", *International Journal of Naval Architecture and Ocean Engineering*, vol. 9, pp. 77-99, 2017.

- [18] I. López, B. Pereiras, F. Castro and G. Lglesias, "Performance of OWC Wave Energy Converters: Influence of Turbine Damping and Tidal Variability", *International Journal of Energy Research*, vol. 39, pp. 472-483, 2015.
- [19] S. Okamoto, T. Kanemoto, H. Bin and T. Umekage, "Flow around wells type runner installed in floating type unique ocean wave power station", *Journal of Energy and Power Engineering*, vol. 8, pp. 1974-1981, 2014.
- [20] H. Polinder and M. Scuotto, "Wave energy converters and their impact on power systems", in *International Conference of Future Power Systems*, Amsterdam, Netherlands, November 2005, p. 1-9.
- [21] M. French, "On the difficulty of inventing an economical sea wave energy converter: a personal view", *Proceedings of the institution of mechanical engineers, part M, Journal of Engineering for the Maritime Environmental*, vol. 220, no. 3, pp. 149-155, 2006.
- [22] A. Kumar, B. Sah, R. Singh, Y. Deng, X. He, P. Kumar and R. Bansal, "A review of multi criteria decision making (MCDM) towards sustainable renewable energy development", *Journal Renewable and Sustainable Energy Reviews*, vol. 69, pp. 596-609, 2017.
- [23] S. Pohekar and M. Ramachandran, "Application of multi-criteria decision making to sustainable energy planning—a review", *Journal of Renewable and sustainable energy reviews*, vol. 8, no. 4, pp. 365-381, 2004.
- [24] J. Wang, Y. Jing, F. Zhang, and H. Zhao, "Review on multi-criteria decision analysis aid in sustainable energy decision-making.", *Journal of Renewable and sustainable energy reviews*, vol. 13, no. 9, pp. 2263-2278, 2009.
- [25] T. Saaty, "Decision making with the analytic hierarchy process", *International Journal of services sciences*, vol. 1, no. 1, pp. 83-98, 2008.
- [26] D. Gravin, "Competing on the eight dimensions of quality", *Harvard Business Review*, vol. 65, no. 6, pp. 101-109, 1987.
- [27] Super Decisions Software v2.8, by *Creative Decisions Foundation*, Retrieved from, <https://www.superdecisions.com/>. (Accessed: 04- Sept.-2017).
- [28] T. Saaty, *Decision Making for Leaders: The Analytic Hierarchy Process for Decisions in a Complex World*, Third Revised Edition. Pittsburgh: RWS Publications, 2012.
- [29] L. Holthuijsen, *Waves in Oceanic and Coastal Waters*, Cambridge University, UK, 2010, pp.119.
- [30] K. Freeman, *Numerical Modelling and Control of an Oscillating Water Column Wave Energy Converter*, Ph.D. Thesis, Plymouth University, Plymouth UK, March 2014, pp.14.
- [31] L. Yeung, P. Hodgson and R. Bradbeer, *Report in: Generating Electricity Using Ocean Waves*, City University of Hong Kong, Hong Kong, 2007, pp.3-4. (online). Available: www.ee.cityu.edu.hk/~rtbrad/wave%20gen.pdf, (Accessed: 25- Jun.-2017).
- [32] T. Thorpe, *An Overview of Wave Energy Technologies: Status, Performance and Costs*, Wave Power: Moving towards Commercial Viability, Broadway House, Westminster, London, UK, 1999, pp.1-16.
- [33] M. Takao and T. Setoguchi, "Review article: air turbines for wave energy conversion", *International Journal of Rotating Machinery, Hindawi Publishing*, vol.1, pp. 1-10, 2012.
- [34] A. Garrido, M. Alberdi, I. Garrido and M. Amundarain, "Control of Oscillating Water Column (OWC) Wave Energy Plants", *Journal of Aout. XXXV Automatic, CEA-IFAC Valencia*, vol. Sept., pp. 1-7, 2014.
- [35] A. Darabi and P. Proiavali, "Guide of Vanes Effect of wells Turbine on OWC Wave Power Plant Operation", in *Proceedings of the World Congress on Engineering WCE*, London, U.K, vol. I, June 2007, p. 1-5.
- [36] Z. Carija, K. Kranjsivic, V. Banic and M. Cavarak, "Numerical Analysis of Wells Turbine for Wave Power Conversion", *Journal of Engineering Review*, vol. 32, no. 3, pp. 141-146, 2012.
- [37] S. Raghunathan and C. Tan, "Performance of the Wells turbine at starting", *Journal of Energy*, vol. 6, no. 6, pp. 430-431, 1982.
- [38] K. Takasaki, M. Takao and T. Setoguchi, "Effect of Blade Shape on the Performance of Wells Turbine for Wave Energy Conversion", *International Journal of Mechanical, Aerospace, Industrial, Mechatronic and Manufacturing Engineering*, vol.8, no. 12, pp. 2073-2076, 2014.
- [39] M. Lalanne and G. Ferraris, *Handbook of Rotodynamics Prediction in Engineering*, Wiley, London, UK, 1997, pp.95-187.
- [40] O. Yaakobi, Y. Ahmed, M. Mazlan, K. Jaafar and R. Muda, "Model Testing of an Ocean Wave Energy System for Malaysian Sea", *World Applied Sciences Journal*, vol. 22, no.5, pp. 667-671, 2013.
- [41] A. Falcao and A. Henriques, "Model-Prototype Similarity of Oscillating-Water-Column Wave Energy Converters", *International Journal of Marine Energy*, vol.6, pp. 18-34, 2014.
- [42] T. Kelly, T. Dooley, J. Campbell and J. Ringwood, "Comparison of the Experimental and Numerical Results of Modeling a 32-Oscillating Water Column (OWC), V-Shaped Floating Wave Energy Converter", *Journal of Energies*, vol. 6, pp. 4045-4077, 2013.
- [43] Y. Kuo, C. Lin, C. Chung and Yu-Kai Wang, "Wave Loading Distribution of Oscillating Water Column Caisson Breakwaters Under Non-Breaking Wave Forces", *International Journal of Marine Science and Technology*, vol. 23, no. 1, pp. 78-87, 2015
- [44] I. Crema, I. Simonetti, L. Cappiotti, H. Oumeraci, "Laboratory Experiments on Oscillating Water Column Wave Energy Converters Integrated in a Very Large Floating Structure", in the *11th International Conference of European Wave and Tidal Energy EWTEC2015*, Mantes, France, September 2015, p. 1-7.
- [45] E. Lijin and S. Ashok, "Design of vertical axis wind turbine for low wind speed application in highway", *International Journal of Power Systems & Microelectronics*, vol. 1, no. 2, pp. 11-20, 2016.