

# Comparative Parametric and Emission Characteristics of Single Cylinder Spark Ignition Engine Using Gasoline, Ethanol, and H<sub>2</sub>O as Micro Emulsion Fuels

Ufaith Qadri, M Marouf Wani

**Abstract**—In this paper, the performance and emission characteristics of a Single Cylinder Spark Ignition engine have been investigated. The research is based on micro emulsion application as fuel in a gasoline engine. We have analyzed many micro emulsion compositions in various proportions, for predicting the performance of the Spark Ignition engine. This new technology of fuel modifications is emerging very rapidly as lot of research is going on in the field of micro emulsion fuels in Compression Ignition engines, but the micro emulsion fuel used in a Gasoline engine is very rare. The use of micro emulsion as fuel in a Spark Ignition engine is virtually unexplored. So, our main goal is to see the performance and emission characteristics of micro emulsions as fuel, in Spark Ignition engines, and finding which composition is more efficient. In this research, we have used various micro emulsion fuels whose composition varies for all the three blends, and their performance and emission characteristic were predicted in AVL Boost software. Conventional Gasoline fuel 90%, 80% and 85% were blended with co-surfactant Ethanol in different compositions, and water was used as an additive for making it crystal clear transparent micro emulsion fuel, which is thermodynamically stable. By comparing the performances of engines, the power has shown similarity for micro emulsion fuel and conventional Gasoline fuel. On the other hand, Torque and BMEP shows increase for all the micro emulsion fuels. Micro emulsion fuel shows higher thermal efficiency and lower Specific Fuel Consumption for all the compositions as compared to the Gasoline fuel. Carbon monoxide and Hydro carbon emissions were also measured. The result shows that emissions decrease for all the composition of micro emulsion fuels, and proved to be the most efficient fuel both in terms of performance and emission characteristics.

**Keywords**—AVL Boost, emissions, micro emulsion, performance, SI engine.

## I. INTRODUCTION

It is well known that fossil fuel reserves are diminishing at an alarming rate, so the need is to work on various alternative technologies in order to avoid energy crises. Various alternative fuels are already in use and have been commercialized in many countries including India. The most commonly used fuel is Ethanol, as blended fuel in conventional gasoline. Ethanol is one of the alternative fuels obtained from sugar cane, starch (corn, wheat, grains). Ethanol

is classified into two groups: "First-generation" or conventional bio fuels are made from vegetable oil, starch, or sugar. Correspondingly, second generation ethanol is produced from biomass (straw, wood, and grasses) with scientific knowledge which are under technical description [1]. In 1989 ethanol-fuelled vehicles sales fell dramatically due to insufficient ethanol production and to high selling price at gas stations. Ethanol is an ecological fuel, as it is obtained from renewable energy sources. It contributes for CO<sub>2</sub> reduction in the atmosphere through photosynthesis of the vegetable source. In Brazil, anhydrous ethanol and hydrous ethanol are produced from sugar-cane. Anhydrous ethanol has a maximum water mass content of 0.7%, measured at the temperature of 20°C, and is added as an antiknock additive to regular gasoline at a concentration between 20% and 25%. The maximum water concentration of ethanol is 7.4% and is used as fuel in commercial vehicles and generators. Many vehicles that can run on gasoline and ethanol are actually responsible for sale of cars in Brazil and its commercialization will continue to remain in coming years. Thus, the objective of this work is to evaluate engine performance when hydrous ethanol (ethanol with 6.8% water mass content) or regular gasoline (with 22% v/v anhydrous ethanol) is used as fuel. A production 1.0-l flex-fuel engine was used for the investigation [2]. Micro emulsions, or  $\mu$ -emulsions, are isotropic mixtures of oil, water and surfactant; usually with a co-surfactant and the oil being a mixture of different hydrocarbons and olefins. The emulsions are kinetically stable although but they are unstable thermodynamically and there is phase separation. Micro emulsions, being stable thermodynamically for their formation they, do not require shear conditions and high inputs of energy micro emulsions are transparent crystal clear unlike emulsions which have milky appearance [3].

### A. Techniques for Finding Size of Micro Emulsions

In the course of development of micro emulsions, different techniques have played an important role in the process and helped scientists to understand the different aspects of micro emulsion science. Nuclear magnetic resonance (NMR) and infrared spectroscopy are among the oldest techniques used for the investigation of micro emulsions. Using NMR measurements, Gilberg and co-workers have indicated that in the case of micelles with a larger water core the packing density of surfactant molecules is low, and consequently, the stability of such micelles are lower than the micelles with

Ufaith Qadri is with the Department of Mechanical Engineering, Faculty of Engineering, National Institute of Technology Srinagar India 190006 (e-mail: ufaith.qadri@gmail.com).

M Marouf Wani is with the Department of Mechanical Engineering, Faculty of Engineering, National Institute of Technology Srinagar India 190006.

higher packing density [4]. Stilbs has demonstrated that by solubilisation of the short-chain n-alcohols in micro emulsions containing SDS micelles the  $^1\text{H}$  NMR line broadening occurs [5]. He concluded that the results are an indication of the highly disordered structures only, and the addition of the short-chain n-alcohols causes the breakdown of the micelles. Also, it was shown that by increasing of the surfactant concentration the growth in micellar size occurs progressively, and at higher concentrations long prolate-shaped aggregates form. The addition of water to the bicontinuous micro emulsions, studied by  $^{13}\text{C}$ -NMR chemical shift trends of C8G2 and pentanol carbons, indicated a reduction in the mean surfactant film curvature towards water [6]. The measurement of the rotational correlation time ( $\tau$ ) of a nitroxide labelled fatty acid probe, 5-doxy stearic acid, versus cetyltrimethylammonium bromide (CTAB) (as surfactant) concentration in aqueous solution has been done via ESR spectroscopy [7].

Micro emulsions play a great role in the everyday life of the human body. There are many final products which, in principle based on the micro emulsions and/or they are somehow in very close relation with the micro emulsions. Sometimes the micro emulsion formation is the important process that occurs at the final stage of the application. However, in every case, the formation of the micro emulsion results in the solubilisation of the chemicals which may be the active agent or the unwanted compound that its removal is the first task of the process. Or in some cases, this solubilisation helps to deliver the active agents to the required sites. Any formulation which is intended to be used in an industrial scale should be economical. Various types of cleaning processes are one of the main areas that relates to the application of the micro emulsions in big scales. Some of the other areas include: agrochemicals formulations [8], [9], solubilising organic agrochemicals in water, preparation of the vaccine adjuvants to improve the effectiveness of the active compounds [10], [11], micro and emulsion polymerization [12], [13], floatation process in the pulp and paper industry, concrete and asphalt production, and the petroleum industry (for example in enhanced oil recovery, natural gas dehydration and etc.) [14], [15], fire fighting foams, defogging agents, as well as decontamination of the media from chemical and biological agents, and many more [16]. Also, the formulation of cosmetics [17], and medical and food additives are the other important areas that require very exact control and analysis. According to statistics, in 2003 about 2 million  $\text{m}^3$  of surfactants, made from fatty alcohols had been consumed [18]. There are many more reports in the literature that indicate the importance and level of applications of these types of compounds [19].

## II. STRUCTURE AND DYNAMICS OF MICRO EMULSIONS [20]

Micro emulsions are not static, impenetrable structures but very labile systems where rapid exchanges of individual components between the various environments as well as spontaneous fluctuation of the interfacial film occur continuously. Droplets phases O/W micro emulsion: In the

case of oil- in-water (O/W) micro emulsions, droplets are formed with the surfactants head-groups oriented towards the continuous water phase and the non-polar tails grouped inside the hydrophobic core of the aggregate. O/W micro emulsion in oil-rich micro emulsions, water is solubilised as small droplets surrounded by a membrane of surfactant and co-surfactant molecules.

### A. Difference between Emulsions and Micro Emulsions [20]

Emulsions are stable dispersions of immiscible liquids, but they are not thermodynamically stable. Table I shows the difference between Emulsion and Micro emulsions.

TABLE I  
THE COMPARISON AND PROPERTIES OF EMULSIONS AND MICRO EMULSIONS

	Emulsions	Micro emulsions
<b>Appearance</b>	Cloudy	Transparent
<b>Microstructure</b>	static	dynamic
<b>Droplet size</b>	1-10 nm	10-100 nm
<b>Stability</b>	Thermodynamically Stable, Kinetically unstable	Thermodynamically Phases Biphasic Monophasic
<b>Formation</b>	Energy input required	Spontaneous, no energy input required
<b>Cost</b>	Higher cost	Lower cost
<b>Viscosity</b>	High Viscosity	Low viscosity with Newtonian behaviour
<b>Turbidity</b>	Turbid	Transparent
<b>Co-Surfactant used</b>	No	Yes
<b>Size range</b>	0.5-5 $\mu$	<0.1 $\mu$

## III. SIMULATION SETUP

TABLE II  
ENGINE SPECIFICATIONS

Criteria	Description
Make	Briggs & Stratton
Type	Air Cooled 4stroke OHV Gasoline
Displacement	206cc
Compression ratio	9
Bore & Stroke	65.09 $\times$ 61.91
Maximum HP	6.5
Cooling System	Air Cooled
Ignition System	Magnetron Electronic

The 1-Dimensional engine simulation model is developed using AVL BOOST software and has been used to study the engine performance and exhaust emissions working on propane-gasoline dual fuel blends. The engine model used in this simulation was a four stroke, single cylinder spark ignition engine without catalytic convertor. The engine model was calibrated by AVL and its layout is shown in Fig. 1, with engine specifications shown in Table II. The various elements of AVL BOOST software enables to develop a model of a one- dimensional engine test bench setup by using the pre-defined elements which are present in the software toolbox. All these elements are joined by various connectors for making the engine model complete by using pipelines. In Fig. 1, the engine is denoted by  $E_1$ , while C1 represent the single cylinder of the engine. MP1 to MP7 represent the measuring points. PL1 PL2 and PL3 represent the plenum. SB1 and SB2

are for the system boundary. The flow pipes are numbered 1 to 10. CL1 represents the cleaner. R1 to R3 represent flow restrictions [21].

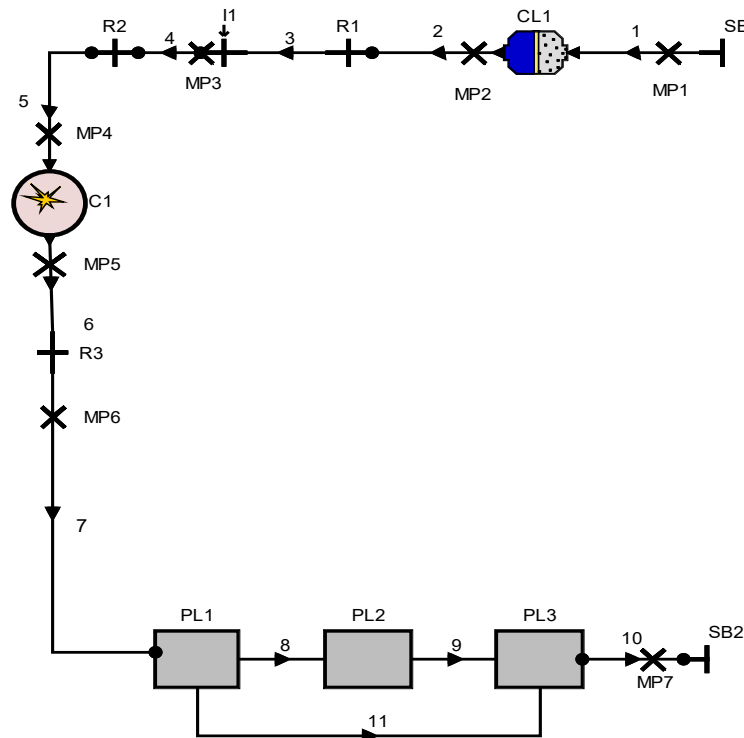

Fig. 1 Layout of single cylinder SI engine 1-Dimensional Gasoline Engine Model, SB1 (System boundary), MP1 (Measuring point), CL1 (Cleaner), R1 (Restriction in flow), C1 (Cylinder), PL1 (Plenum), E1 (Engine)

#### IV. MODEL FORMULATION

The basic equation for the engine model that is derived from first law of thermodynamics is:

$$\partial E = -\partial Q - \partial W + \sum_i h_i dm_i \quad (1)$$

where  $E$  is the internal energy of the cylinder gas mixture,  $Q$  is the heat exchange of the cylinder contents with the cylinder walls,  $W$  is the work,  $h_i$  is the specific enthalpy of gas which enters or leaves the cylinder, and  $dm_i$  is the mass flow into (+) or out of (-) the cylinder,  $\partial W$  can be expressed as  $P.dv$ , where  $P$  is the pressure and  $V$  is the cylinder volume [22].

##### A. Mathematical Model

Mathematical models for spark-ignition engines can be divided into two main groups: thermodynamic and dimensional models. Thermodynamic models can in turn be classified. In two sub groups - single and multi zone models - whereas dimensional models can be divided into one and multi dimensional models [23]. In single-zone models the cylinder charge is assumed to be uniform in pressure, temperature, and composition. These models can be used as diagnostic (heat release analysis) or predictive tools. Because of their simplicity, single zone models, can account for mass flows into and out of crevices. However, they ignore the flame propagation and combustion chamber geometry. Single zone

models can also be used as predictive tools if the mass burning rate is specified. The mass burning rate depends on the combustion duration, ignition angle, engine geometry, equivalence ratio, residual mass etc. Therefore, tuning may be required to predict the pressure diagrams in different engines or in the same engine operating under different conditions.

Multi zone models attempt to resolve the combustion phenomena in a more physical manner than do single-zone models. The combustion chamber is generally divided into burnt and unburnt regions; sometimes, the thermal boundary layers in the burnt and unburnt gases are also considered. The cylinder charge is frequently assumed to be composed of ideal gases (frozen in the unburnt-gas region and in chemical equilibrium in the burnt-gas region), and the first law of thermodynamics, equation of state, and conservation of mass and volume are applied to the burnt and unburnt gases [23].

##### B. Single - Zone Models

In single zone models, the pressure, temperature, and composition of the cylinder charge are assumed to be uniform. These models define the state of the cylinder charge in terms of average properties, do not distinguish between burnt and unburnt gases, and assume that the cylinder charge is homogenous. Multi zone models permit a more accurate treatment of the thermodynamic properties of the cylinder mixture; the burnt and unburnt gases are considered as

separate thermodynamic systems that are uniform in composition and state. However, the geometry of each zone must be tracked in order to calculate the heat transfer and composition of the burnt and unburnt gases are considered as separate thermodynamic systems that are uniform in composition and state. Combustion in single-zone models can be considered as a heat addition process, and the chamber charge is regarded as a simple fluid.

The first law of thermodynamics applied to an open system can be written as:

$$\frac{d(m_e)}{d\theta} = -p \frac{dV}{d\theta} - \frac{dQ}{d\theta} + \sum \dot{m}_i h_i = e^0 + \int_{T_0}^T C_v dT \quad (2)$$

where  $P$ ,  $T$ , and  $m$  are the pressure, temperature, and mass of the cylinder charge, respectively is the mixture specific internal energy;  $C_v$  is the specific heat at constant volume;  $V$  is the combustion chamber volume;  $dQ/d\theta$  represents the heat losses;  $h_i$  is the specific enthalpy of the gases flowing into the cylinder with a mass flow rate equal to  $\dot{m}_i$ ;  $T_0$  is a reference temperature;  $e^0$  is the internal energy of formation at the reference temperature  $T_0$ ; and  $\theta$  is the crank shaft angle. In the absence of injection and flows into crevices,  $dm/d\theta = 0$ . In premixed charge engines, there are flows into and out of crevices (i.e. volumes between the piston, cylinder wall, and piston rings and the spark plug threads). The crevices can be modelled as a single volume at the cylinder pressure or as a series of volumes, connected by restrictions to simulate the piston ring- cylinder wall region and blow by. Equation (1) can be written as:

$$\frac{dQ_{CH}}{d\theta} = m C_v \frac{dT}{d\theta} + p \frac{dV}{d\theta} + \frac{dQ}{d\theta} + (h - e) \frac{dm_{CR}}{d\theta} \quad (3)$$

where  $dQ_{CH}/d\theta$  represent the heat released by combustion,  $dm_{CR}/d\theta$  represents the mass flow rate into crevices, and  $h$  is the specific enthalpy.

Conservation of mass applied to the combustion chamber yields:

$$\frac{dm}{d\theta} = - \frac{dm_{CR}}{d\theta} \quad (4)$$

When the cylinder pressure is high,  $\frac{dm_{CR}}{d\theta} > 0$  and the value of  $h$  corresponds to that in the combustion chamber:

$$h = e + PV/m \quad (5)$$

However, during the expansion stroke,  $dm_{CR}/d\theta < 0$  and the value of  $h$  is that of the gases contained in the crevices.

If the crevice volume and temperature are assumed constant and the crevice pressure is equal to that of the cylinder charge, the mass flow rate into the crevices can be written as:

$$\frac{dm_{CR}}{d\theta} = V_{CR} \frac{dp/d\theta}{RTW} \quad (6)$$

where the crevice temperature was set equal to the temperature of the cylinder wall  $T_w$  and  $V_{CR}$  is the crevice volume.

Equation (5) can be substituted into (2) and (3) to obtain an equation for the heat released by combustion once the heat transfer losses  $dQ/d\theta$  are specified. Heat transfer correlations once the heat transfer losses  $dQ/d\theta$  are specified [24].

For the production of fuel, it is necessary to have a mixing device that is able to generate turbulence flow which is homogeneous and able allow to control the intensity of the turbulence. The mechanism formation of micro emulsion is shown in Fig. 2 [25].

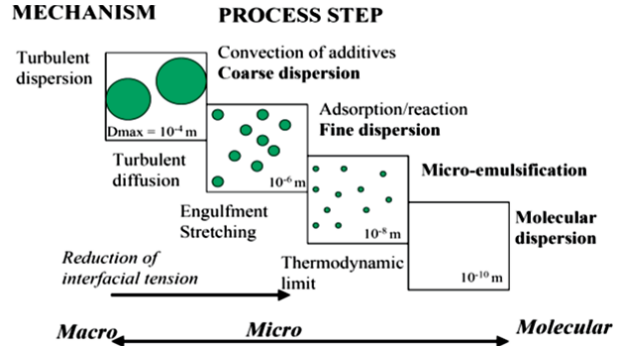

Fig. 2 Schematic of Micro emulsion production [25]

## V. RESULTS AND DISCUSSION

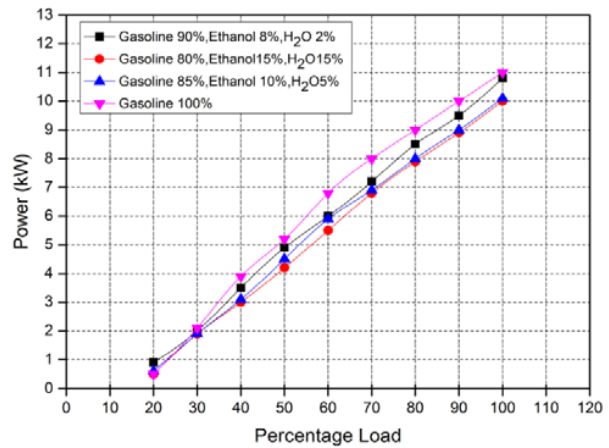

Fig. 3 Plot between power and varying percentage load under constant speed (rpm)

Fig. 3 shows the continuous increase in power with increase in load. Power increases for all the micro emulsion fuels with increase in load. As the load on the engine increases, the power shows increase for gasoline fuel more than micro emulsion fuel; however, the increase is slightly high, and this happens due to the higher heating value of the gasoline fuel. The most efficient composition of micro emulsion fuel in terms of power is when the gasoline is 90%, ethanol 8%, and water 2% because power shows some increase at higher loads.

In Fig. 4, the torque is continuously increasing for all the percentage variations, as load increases, the torque on the engine also increases. Since torque is directly related to power, the load on the engine is obtained in terms of power. So, with increase in load, torque also increases. For all the micro

emulsion fuels, torque shows continuous increase for varying percentage loads. The most efficient fuel although was found to be gasoline 90%, ethanol 8%, and water 2%, respectively.

This increase of torque increases the power of the engine, as torque is directly related to the power of the engine.

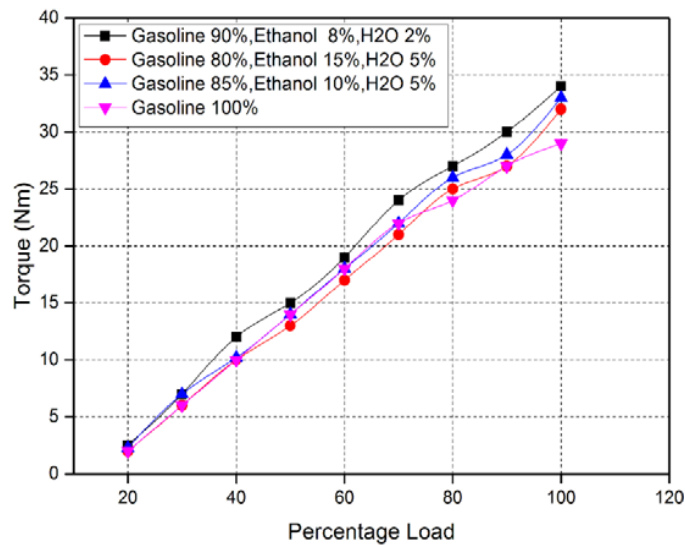

Fig. 4 Plot comparison between Torque and varying percentage load under constant speed

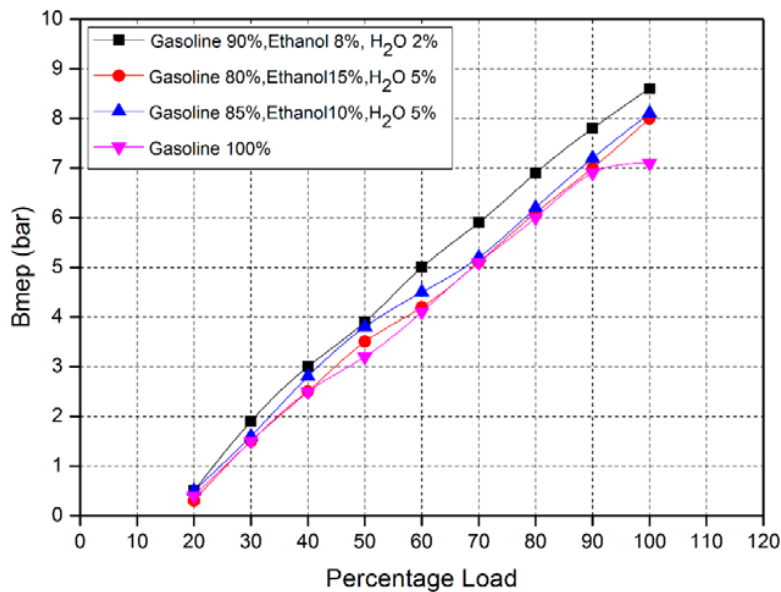

Fig. 5 Plot comparison between BMEP and percentage load under constant speed

Fig. 5 shows the variation of BMEP with load on the engine. As the percentage load increases, the BMEP also increases for almost all the micro emulsion fuels including conventional gasoline fuel. But the most increase in BMEP is for gasoline 90%, ethanol 8%, and water 2%, respectively. This increase in pressure explains that the work done by the engine per unit power is more; thus, the fuel is efficient.

In Fig. 6, we can see the variation of BSFC with increase in load. In this diagram, the BSFC is higher at lower loads for almost all the micro emulsion fuels. Again, we can see the

conventional gasoline fuel as having higher BSFC at lower loads. This happens because of the very rich mixture at the start of the combustion. Thus, BSFC also increases; however, we can see after the increase in the load that the mixture goes more towards the leaner side, and so, BSFC also decreases and combustion is also completed fully with lesser emissions. The BSFC is less for micro emulsion fuels, and therefore, fuels are more efficient in terms of fuel economy and the most efficient fuel was found to be gasoline 90%, ethanol 8%, and water 2%, respectively.

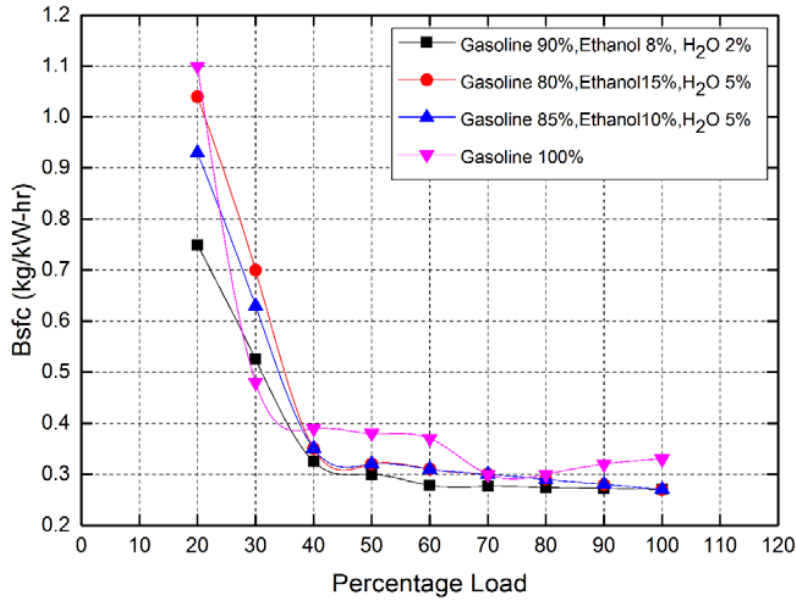

Fig. 6 Plot comparison between BSFC and varying percentage load under constant speed

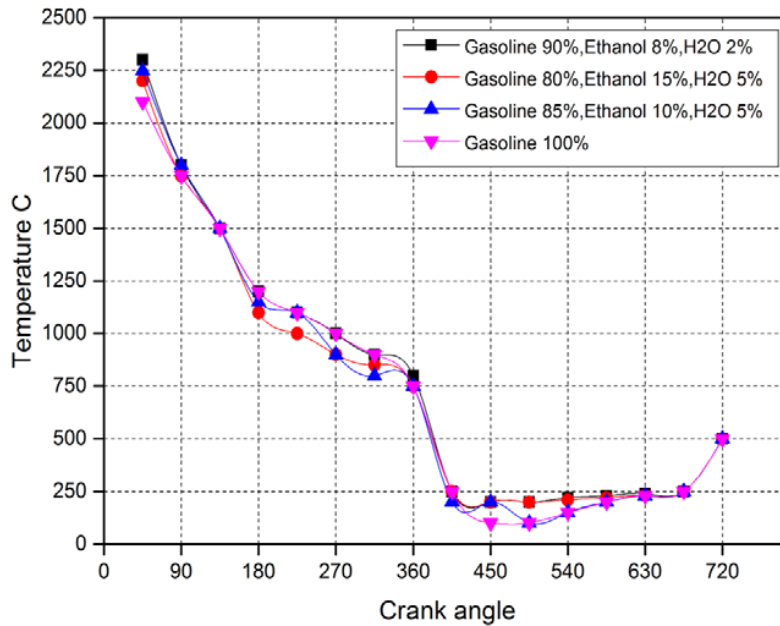

Fig. 7 Plot comparison between temperature and crank angle under constant speed

Fig. 7 shows the relation between temperature and crank angle, where the temperature shows continuously decrease with increase in the crank angle of the engine. The temperature at the start of combustion is highest, as during the compression stroke, there is more pressure present inside the combustion chamber. With the increase in pressure, the temperature also increases inside the combustion chamber resulting into the liberation of tremendous heat and energy, which then gives force to the piston for completing the power stroke. As can be seen from the plot that temperature is almost same for all the compositions of micro emulsion fuels, so we

can say that micro emulsion fuel is having the same energy as the conventional fuel has, and it can be used as fuel for the purpose of commercialization.

Fig. 8 shows a comparison is between the pressure and crank angle. Since the pressure is varying for all the four strokes of the engine, the maximum pressure, as can be seen, is at the start of combustion which is when the compression stroke starts. As can be noticed from the graph, the maximum pressure is for the composition of gasoline 85%, ethanol 10%.and water 5%. Therefore, it can be concluded that the most efficient fuel in terms of highest pressure and maximum

efficiency is the above micro emulsion compositions.

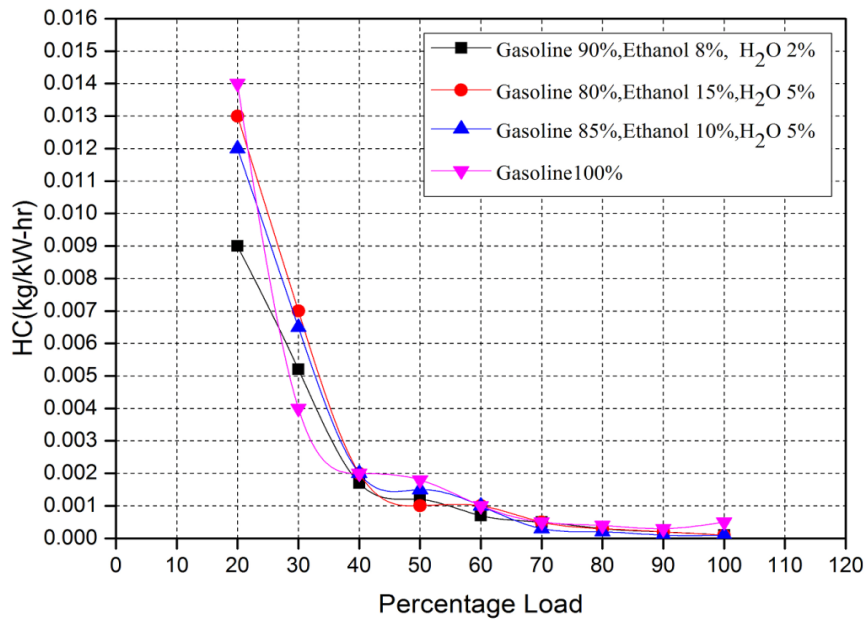

Fig. 8 Plot comparison between pressure and percentage load under constant speed (rpm)

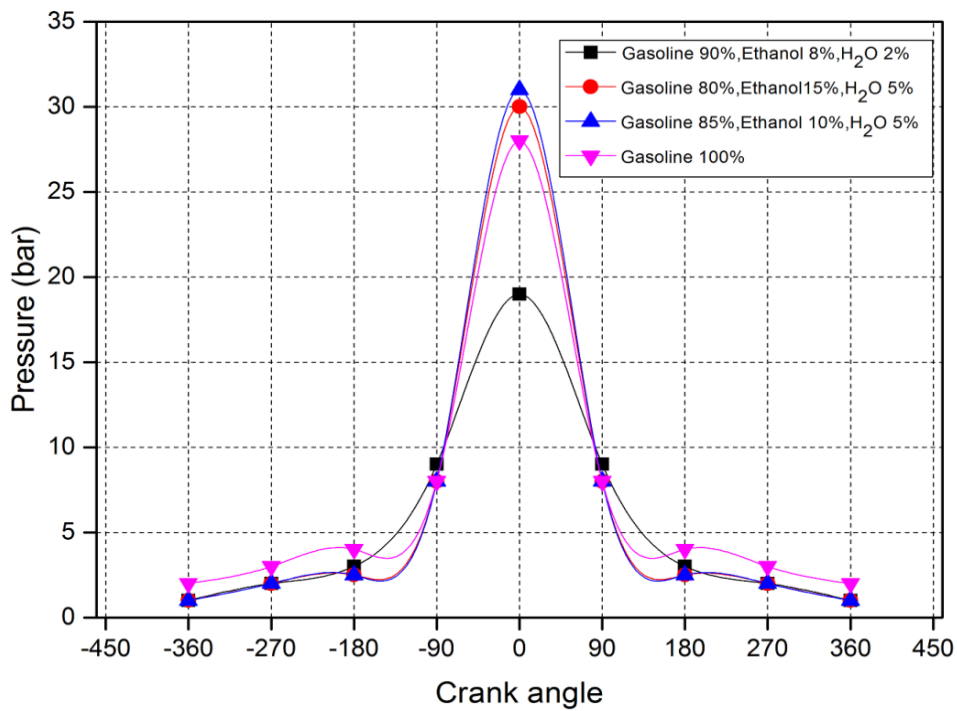

Fig. 9 Plot comparison between HC and percentage load under varying speed (rpm)

In Fig. 9, the plot clearly shows how hydro carbon emissions decrease with increase in load. As we start increasing the load, hydro carbon emissions also decrease for almost all the micro emulsion compositions. The highest hydro carbon emission formation is for the 100% gasoline fuel, which is the conventional fuel for SI engines, while the

most efficient fuel in terms of exhaust emissions is micro emulsion having composition of gasoline 90%, ethanol 8%, and water 2%. This increase in hydro carbon emissions is due to the fact that some fuel avoids the flame zones. Further, some regions of the combustion chamber may have a very weak flame; that is, they have either very fuel-lean or very

fuel-rich conditions, and consequently, they have a low combustion temperature and this results in the formation of aldehydes, alkenes to be emitted.

In Fig. 10, CO emissions are showing an increase with the increase in load. As the load increases, CO also increases for all the fuels, as seen from the plot, the carbon monoxide emissions are more for gasoline fuel. The micro emulsion fuel is more efficient fuel in terms of carbon monoxide emissions.

At the start of load there is very less emission formation for almost all the fuels, then it varies continuously and carbon monoxide emissions start increasing. The most efficient fuel is found to be gasoline 80%, ethanol 15%, and water 5%, respectively. As the fuel does not get sufficient time for complete oxidation, the incomplete combustion of the fuel in the combustion chamber produces carbon monoxide.

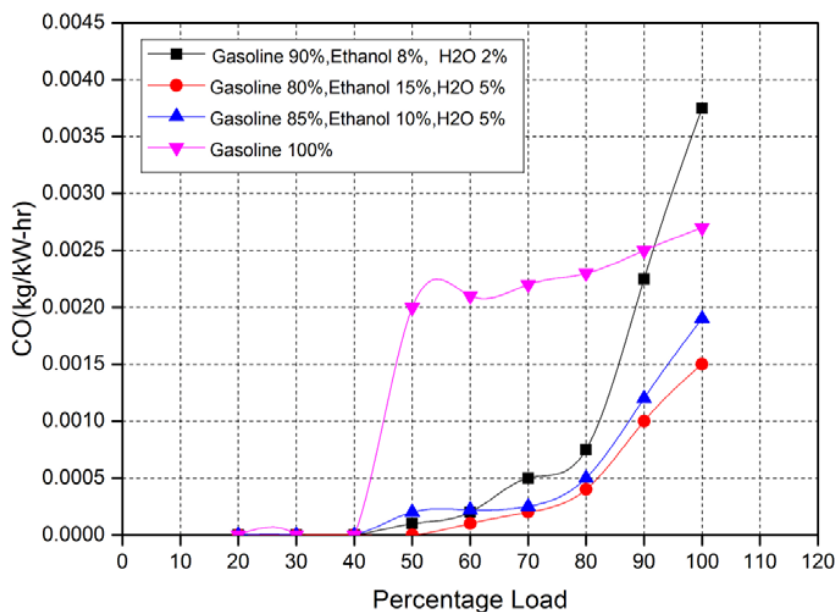

Fig. 10 Plot comparison between CO and varying percentage loads under constant speed

## V. CONCLUSION

This study focuses on the comparative parametric investigation on single cylinder SI engine using pure gasoline and various micro emulsion blends in order to see which composition is more efficient both in terms of performance and emission characteristics. The following conclusion can be drawn from the above investigation:

- The performance and emission characteristics of both gasoline and micro emulsions were checked using AVL Boost simulation software.
- Since the engine is designed to run on gasoline only, thus, power increases for gasoline more as compared to micro emulsion fuel.
- Micro emulsion fuels show overall increase in other performance parameters like Torque and BMEP.
- Micro emulsions show a decrease in emissions as compared to pure gasoline, and prove to be efficient and less harmful to the environment.
- The most efficient composition of micro emulsion fuel was found to be 90% Gasoline, 8% Ethanol and 2% H<sub>2</sub>O both in terms of performance and emission formations.

## REFERENCES

- [1] M. Eyidogan, A. N. Ozsezen, M. Canakci, A. Turkcan, Impact of alcohol-gasoline fuel blends on the performance and combustion characteristics of an SI engine, *Fuel*. 89 (2010) 2713–2720. doi:10.1016/j.fuel.2010.01.032.
- [2] R. C. Costa, J. R. Sodré, Hydrous ethanol vs. gasoline-ethanol blend: Engine performance and emissions, *Fuel*. 89 (2010) 287–293. doi:10.1016/j.fuel.2009.06.017.
- [3] B. K. Paul, S. P. Moulik, Applications and Use of Micro emulsions, *Curr. Sci.* 80 (2001) 990–1001. doi:10.1007/978-1-4614-1205-2.
- [4] Gillberg, G. Lehtinen, H. and Friberg, S. (1970). NMR and IR Investigation of the Conditions Determining the Stability" of Micro emulsions, *J. Colloid Interface Sci.*, Vol. 33, No. 1, pp.40-53.
- [5] Stilbs, P., (1982). Micellar breakdown by short-chain alcohols. A multicomponent FT-PGSE-NMR self-diffusion study, *J. Colloid Interface Sci.*, Vol 89, No 2, pp. 547-554.
- [6] Parker, W. O., Genova, Jr., C., and Carignano, G. (1993). Study of micellar solutions and micro emulsions of an alkyl oligoglucoside via NMR spectroscopy, *Colloids Surf. A: Physicochem. and Eng. Asp.* Vol. 72, pp. 275-284.
- [7] Li, F., Li, G.-Z., Wang, H.-Q., and Xue, Q.-Ji, (1997). Studies on cetyltrimethyl-ammonium bromide (CTAB) micellar solution and CTAB reversed micro emulsion by ESR and <sup>2</sup>H NMR, *Colloids Surf. A: Physicochem. and Eng. Asp.*, Vol 127, pp. 89-96.
- [8] Mulqueen, P., (2003). Recent advances in agrochemical formulation. *Adv. Colloid Interface Sci.*, Vol. 106, No. 1–3, pp. 83-107.
- [9] Chen, F., Wang, Y., Zheng, F., Wu, Y., and Liang W., (2000). Studies on cloud point of agrochemical micro emulsions. *Colloids Surf. A: Physicochem. Eng. Asp.* Vol. 175, No. 1–2, pp. 257-262.
- [10] O'Hagan, D. T., Ott, G. S., and Van Nest G., (1997). Recent advances in vaccine adjuvants: the development of MF59 emulsion and polymeric micro particles. *Molecular Medicine Today*, Vol, 3, No. 2, pp. 69-75.
- [11] Hariharan, K., and Hanna, N., (1998). Development and application of PROVAX™ adjuvant formulation for subunit cancer vaccines. *Adv. Drug Delivery Rev.*, Vol. 32, No. 3, pp. 187-197.
- [12] Xu, X.-J., and Gan L. M., (2005). Recent advances in the synthesis of



- nanoparticles of polymer latexes with high polymer-to-surfactant ratios by micro emulsion polymerization. *Current Opinion in Colloid & Interface Science*, Vol. 10, No. 5–6, pp. 239-244.
- [13] Capek I., (2001). Micro emulsion polymerization of styrene in the presence of a cationic emulsifier. *Adv. Colloid Interface Sci.*, Vol. 92, No. 1–3, pp. 195-233.
- [14] Santana, V. C., Curbelo, F. D. S., Castro Dantas, T. N., Dantas Neto, A. A., Albuquerque, H. S., and Garnica, A. I. C., (2009). Micro emulsion flooding for enhanced oil recovery. *J. Petroleum Sci. Eng.*, Vol. 66, No. 3–4, pp. 117-120.
- [15] Austad, T., and Taugbøl, K., (1995). Chemical flooding of oil reservoirs 2. Dissociative surfactant-polymer interaction with a negative effect on oil recovery. *Colloids Surf. A: Physicochemical. Eng. Asp.*, Vol. 103, No. 1–2, pp. 73-81.
- [16] Solans, C., and Kunieda, H., (1997), *Industrial Applications of Micro emulsions*. Marcel Dekker Inc., New York, and references cited therein.
- [17] Valenta, C., and Schultz, K., (2004). (Influence of carrageenan on the rheology and skin permeation of micro emulsion formulations. *J. Controlled Release*, Vol. 95, No. 2, pp. 257-265.
- [18] Brackmann, B., and Hager, C.-D., (2004). The statistical world of raw materials, fatty alcohols and surfactants, *Proceedings 6th World Surfactant Congress CESIO*, Berlin Germany.
- [19] R. Najjar, *Micro emulsions: An Introduction to Properties and Applications*, Intech. (2012) 1–30. doi:10.5772/2300.
- [20] M. A. Chordiya, *Organised Surfactant System: Micro Emulsion*, 1 (2017) 1–3.
- [21] A. Hans-List-Platz 1, A-8020Graz, AVL LIST GmbH, in: *AVL Boost*, 07/2009, 2009: p. 87. doi:07/2009.
- [22] A. M. Pourkhesalian, A. H. Shamekhi, F. Salimi, Alternative fuel and gasoline in an SI engine: A comparative study of performance and emissions characteristics, *Fuel*, 89 (2010) 1056–1063. doi:10.1016/j.fuel.2009.11.025.
- [23] J. I. Ramos, *Internal Combustion Engine Modelling*, CRC Press (3 August 1989), 1989.
- [24] S. Verhelst, C.G.W. Sheppard, Multi-zone thermodynamic modelling of spark-ignition engine combustion - An overview, *Energy Convers. Manag.* 50 (2009) 1326–1335. doi:10.1016/j.enconman.2009.01.002.
- [25] A. Jankowski, Influence of Chosen Parameters of Water Fuel Micro emulsion on Combustion Processes, Emission Level of Nitrogen Oxides and Fuel Consumption of Ci Engine, *J. KONES Powertrain Transp.* 18 (2011).