

# Thermo-Exergy Optimization of Gas Turbine Cycle with Two Different Regenerator Designs

Saria Abed, Tahar Khir, Ammar Ben Brahim

**Abstract**—A thermo-exergy optimization of a gas turbine cycle with two different regenerator designs is established. A comparison was made between the performance of the two regenerators and their roles in improving the cycle efficiencies. The effect of operational parameters (the pressure ratio of the compressor, the ambient temperature, excess of air, geometric parameters of the regenerators, etc.) on thermal efficiencies, the exergy efficiencies, and irreversibilities were studied using thermal balances and quantitative exergetic equilibrium for each component and for the whole system. The results are given graphically by using the EES software, and an appropriate discussion and conclusion was made.

**Keywords**—Exergy efficiency, gas turbine, heat transfer, irreversibility, optimization, regenerator, thermal efficiency.

## I. INTRODUCTION

IN gas turbine units, the temperature of the exhaust gases leaving the turbine is often considerably higher than the temperature of compressed air which leaves compressor [1]-[3]. Therefore, the high pressure air leaving the compressor can be heated up by transferring heat to it from the hot gases leaving the turbine by a heat exchanger called regenerator before expelling to atmosphere. The thermal efficiency of gas turbine cycle increases as a result of regeneration since the portion of energy of exhaust gases that is normally rejected to the surrounding is now used to preheat the compressed air entering the combustion chamber. This, in turn, decreases the mass of fuel required for the same turbine inlet temperature  $T_3$  [1], [3].

In thermodynamics, the concern is not only for the quantity of energy but also for the quality of energy [4]. The first law efficiency does not take into account the quality of energy. The current work is aimed to analyze the gas turbine efficiency with two different designs of regenerator also from the view of the second law. Exergy analysis has been widely applied to gas turbine cycles.

## II. SIMPLE AND REGENERATIVE GAS TURBINE CYCLES

In the simple cycle, from the compressor inlet point 1, the ambient air is compressed to reach the high pressure at point 2. No heat is added; however, the compression increases the air temperature, so that at the compressor outlet the air is at high temperature and pressure. Leaving the compressor, the

Saria Abed is with National engineering school of Gabes, Tunisia (corresponding author, phone: 0021655512034, e-mail: syria495@gmail.com).

Tahar Khir and Ammar Ben Brahim are with National engineering school of Gabes, Tunisia (e-mail: taherkhir@yahoo.fr, ammar.benbrahim@enig.rnu.tn).

air enters into the combustion chamber where the fuel is injected, and the combustion occurs practically at constant pressure. In fact, the temperature of exhaust gas exiting the turbine is usually much higher than the temperature of the air leaving the compressor. Therefore, the high pressure air leaving the compressor can be heated by heat transfer from the exhaust gas in a heat exchanger acting as a recuperator regenerator [5]. The gas turbine (GT) with regenerator is shown in Fig. 1.

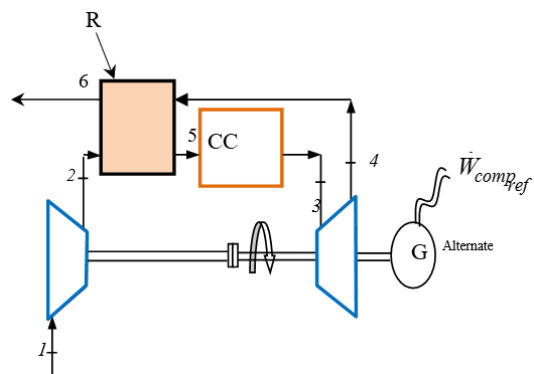

Fig. 1 Gas turbine cycle with regeneration operating mode

## III. ENERGY AND THERMODYNAMIC STUDY

The thermal efficiency is an effective criterion for judging the performance of a cycle, and thus, a thermodynamic study is conducted to determine the thermal efficiency for the simple and regenerative cycles.

The efficiency of simple cycle depends on the power of compressor ( $\dot{w}_{comp}$ ) and turbine ( $\dot{w}_t$ ) and the heat rate ( $\dot{Q}_h$ ). The efficiency is given by:

$$\eta_{cy} = \frac{\dot{W}_{net}}{\dot{Q}_h} = \frac{(\dot{w}_t - \dot{w}_{comp})}{\dot{Q}_h} \quad (1)$$

In function of pressure ratio PR, isentropic efficiencies of compressor and turbine, ambient and combustion temperatures ( $T_1$  and  $T_3$ ), the efficiency becomes:

$$\eta_{cy} = \frac{\eta_t \frac{T_3}{T_1} \left( 1 - \frac{1}{PR^{\frac{k-1}{k}}} \right) \frac{1}{\eta_c} (PR^{\frac{k-1}{k}} - 1)}{\frac{T_3}{T_1} - \left( \frac{PR^{\frac{k-1}{k}} - 1}{\eta_c} + 1 \right)} \quad (2)$$

k: The isentropic exponent of the gas;  $\eta_t$  and  $\eta_c$ : The isentropic efficiency of the turbine and the compressor.

In the cycle with regeneration, the amount of heat changes

and becomes ( $Q_{h,cy}$ ). it is in function of the effectiveness of regenerator ( $\varepsilon$ ):

$$\varepsilon = \frac{Q_{real}}{Q_{max}} \quad (3)$$

$Q_{real}$ : is the actual amount of heat at regenerator;  $Q_{max}$ : is the maximum amount of heat at regenerator

$$\eta_{cy,reg} = \frac{\dot{m}_g \eta_t c_{pg} T_3 \left(1 - \frac{1}{PR^k}\right) - \dot{m}_a \frac{c_{pa} T_1 (T_2 - T_1)}{\eta_c}}{\dot{Q}_{h-\varepsilon Q_{max}}} \quad (4)$$

The UNT method is used to calculate exchanger efficiency, output temperatures, maximum power, and real power. The effectiveness is calculated for a cross flow and unmixed fluids [6].

$$\varepsilon = 1 - \exp\left(\frac{UNT^{0.22}}{c_r}\right) \exp(-c_r(UNT)^{0.78} - 1) \quad (5)$$

UNT: number of transfer unit;  $c_r$  is the ratio of flow capacity.

The overall heat transfer coefficient is given by:

$$\frac{1}{U} = \frac{1}{h_f} + \frac{1}{h_c} + \frac{E}{\lambda_{alum}} + R_{air} + R_g \quad (6)$$

$h_f$  and  $h_c$  are the exchange coefficient hot and cold side;  $\lambda_{alum}$  is the thermal conductivity of aluminum;  $R_{air}$  and  $R_g$  are the resistances to fouling air and gas.

The heat transfer coefficient by convection is expressed using:

$$h = \frac{Nu \lambda}{D_h} \quad (7)$$

Nu: Nusselt number.

#### IV. EXERGY STUDY

For all equipment, the exergy efficiency is:

$$\eta_{ex,i} = \frac{\dot{E}_{p,i}}{\dot{E}_{f,i}} \quad (8)$$

Product and fuel are donated by p and f, respectively.

##### A. Exergy in the Compressor

$$\dot{E}_{p,c} = \dot{m}_a * ((c_{p,a} * (T_2 - T_1) - T_0 * ((c_{p,a} * \ln\left(\frac{T_2}{T_1}\right) - R_a * \ln\left(\frac{P_2}{P_1}\right))) \quad (9)$$

$$\dot{E}_{f,c} = \dot{W}_c = \dot{m}_a * c_{p,a} * (T_2 - T_1) \quad (10)$$

##### B. Exergy in the Combustion Chamber

$$\dot{E}_{f,cc} = \dot{E}_{fuel} \quad (11)$$

$$\dot{E}_{f,cc} = \dot{m}_f * PCI \quad (12)$$

$$\dot{E}_{p,cc} = \dot{E}_3 - \dot{E}_5 \quad (13)$$

$$\dot{E}_5 = \dot{m}_a * (c_{p,a} * (T_5 - T_0) - T_0 * (c_{p,a} * \ln\left(\frac{T_5}{T_0}\right) R \ln\left(\frac{P_5}{P_0}\right))) \quad (14)$$

$$ex_3 = ex_3^{ph} + ex_3^{chim} \quad (15)$$

$$ex_3^{ph} = \dot{m}_g * \left( c_{p,g} * (T_3 - T_0) - T_0 * \left( c_{p,g} * \ln\left(\frac{T_3}{T_0}\right) - R \ln\left(\frac{P_3}{P_0}\right) \right) \right) \quad (16)$$

$$ex_3^{chim} = \sum_{i=1}^n X_i * ex_i^{ch} + R * T_0 \sum_{i=1}^n X_i * \ln(X_i) \quad (17)$$

$$ex_i^{ch} = \mu_{i,0} - \mu_i^e \quad (18)$$

The reaction of combustion is:  $aCH_4 + bC_2H_6 + dC_3H_8 + eN_2 + kCO_2 + jO_2 \rightarrow lCO_2 + mN_2 + nO_2 + oH_2O + pNO$

##### C. Exergy in Regenerator

$$\dot{E}_{p,reg} = \dot{E}_5 - \dot{E}_2 \quad (19)$$

$$\dot{E}_{f,reg} = \dot{E}_4 - \dot{E}_6 \quad (20)$$

##### D. Exergy in the Turbine

$$\dot{E}_{p,t} = \dot{W}_t \quad (21)$$

$$\dot{E}_{f,t} = \dot{E}_3 - \dot{E}_4 \quad (22)$$

##### E. Exergy of the Cycle

$$\eta_{ex,cycle} = \frac{W_{net}}{E_{f,cycle}} \quad (23)$$

## V. REGENERATORS DESIGNS

### A. The First Studied Regenerator

The regenerator used is a cubic static heat exchanger where cold flow (compressed air) and hot flow (exhaust gas from turbine) intersect providing orthogonal cross flow.

The exchanger is treated as a matrix of aluminum plates forming channels of rectangular cross tubes as it is shown in Fig. 2.

The regenerator is interposed at the intersection of the exhaust gas and the compressed air. A suitable ventilator permits the admission of compressed air into the regenerator. The heat exchange between the two streams is provided by forced convection and conduction through the aluminum walls.

The gas and air flows pass through rectangular channels whose dimensions are given in Fig. 3.

### B. The Second Regenerator

This regenerator is a plate-fined heat exchanger and it is interposed in the same way of the first exchange. The overlay of plate is well described in Fig. 4.

The gas and air flows pass through triangular channels whose dimensions are given in Fig. 5:

To facilitate calculations for the corrugated plate exchanger, this exchanger was considered to be a plate exchanger with triangular fins (plate - fins heat exchanger), and a design margin was estimated for the total exchange area of one per cent.

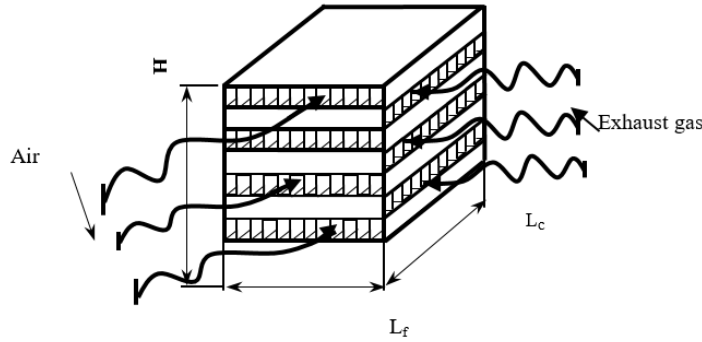

Fig. 2 The first regenerator design; H is the height of the exchanger;  $L_f$  is the length of channel traversed by the exhaust gas;  $L_c$  is the length of channel traversed by the compressed air

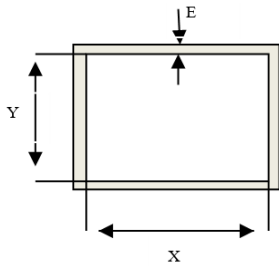

Fig. 3 Dimensions of a channel; X: channel width; Y: channel length; E: thickness of the separating plate

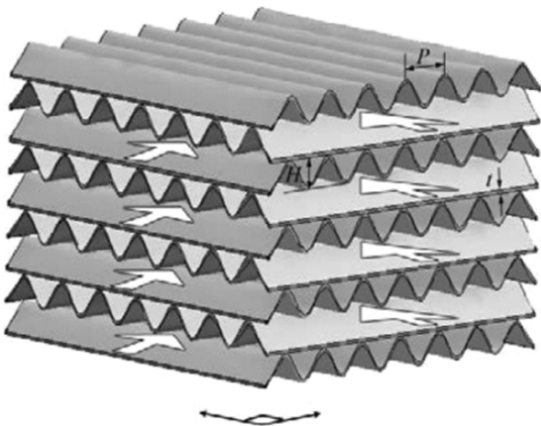

Fig. 4 The second regenerator design

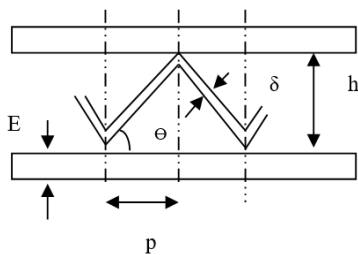

Fig. 5 Dimensions of a channel;  $\delta$ : Fin thickness, mm; E: Thickness of the separating plate; P: Fin pitch, mm; h: Channel height

VI. NUMERICAL SIMULATION AND RESULTS

The considered cycles for numerical simulation are the

simple Brayton cycle and the regenerative GT cycles. To analyze the influence of operating variables on the cycles performances, a simulation code is established using the software EES for a net power of 100 MW.

The operating conditions and the air properties are defined according to those usually considered for the STEG (Tunisian Society of Electricity and Gas) power plant installed in Bouchemma Gabes (South-Est of Tunisia).

The operating variables are: pressure ratio (PR), ambient temperature ( $T_1$ ), humidity (Hu), air excess and geometric parameters of the two regenerators. The range of variation is shown in Table II.

A comparison between the performances of the two heat exchangers was made, and the results are grouped in Table I.

A. Results

Regeneration is a reliable technique for improving the performance of a simple GT cycle, in fact for the operating conditions and the air properties which are defined according to those usually considered for the STEG (Tunisian Society of Electricity and Gas) power plant.

Regeneration improves the thermal efficiency of GT of at least 10%, and the second regenerator is more reliable for the thermal efficiency improvement as it is stated in Fig. 6.

A comparison between the two regenerators from a thermal efficiency point of view is shown in Table I.

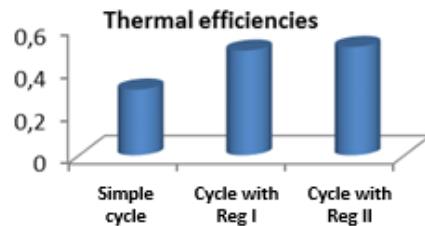

Fig. 6 Thermal efficiencies of cycles

TABLE I  
PERFORMANCES OF REGENERATORS

	$\dot{W}_{COMP}$ (MW)	$\dot{W}_t$ (MW)	$\dot{W}_{net}$ (MW)	$\eta_{th}$	$U$ ( $W/m^2.K$ )	$\epsilon$	$A_{tot}$ ( $m^2$ )
Reg I	93.511	220.542	127.03	0.488	89.59	0.7886	23.34
Reg II	93.511	234.551	141.04	0.505	275.6	0.8679	138.8

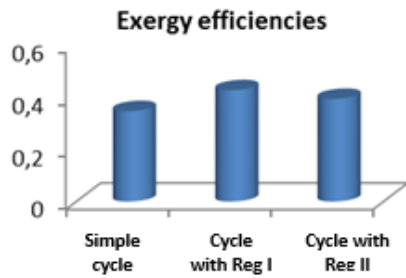

Fig. 7 Exergy efficiencies of cycles

The second regenerator has an overall heat transfer coefficient, higher exchange area, and greater effectiveness, which explains the important thermal efficiency in the second regenerative cycle.

*B. Influence of Operational Parameters*

Table II shows the range of variation of the various parameters.

TABLE II RANGE OF VARIATION	
Operational parameters	Range
Input temperature	10-45 °C
Air humidity ratio	0.45-0.5
Pressure rate	10-12
Excess air	0-0.3
Geometric parameters	
Range	
Regenerator 1: the ratio Y/X	1.5-1.95
Regenerator 2: h (mm)	0.06-0.095

1. Influence of Excess Air

The excess air is one of the parameters affecting the performance of the GT cycles. It was varied from 10% to 30% to analyze its influence on the thermal, exergy efficiencies, and irreversibilities of different cycles.

The excess air significantly affects the power of the turbine and the compressor, the variation of the compressor power with ex and different efficiencies are shown in Figs. 8 and 9, respectively.

Since the excess air increases the power of compressor, the thermal efficiencies and the exergy efficiencies of three cycle decrease as it is shown in Fig. 10.

GTs are designed to operate in ambient conditions, but the temperature and the relative humidity vary greatly between summer and winter. Thus, the performance of GT cycle is affected. So, we will study their influence on the performance of the GT cycles. Fig. 11 shows the variation of efficiency of simple and regenerative cycles with humidity and ambient temperature.

2. Influence of Ambient Temperature

Also, the variation of exergy efficiencies with  $T_1$  is shown in Fig. 12.

3. Influence of Pressure Ratio PR

The compression ratio is one of the parameters affecting the performance of the GT cycle.

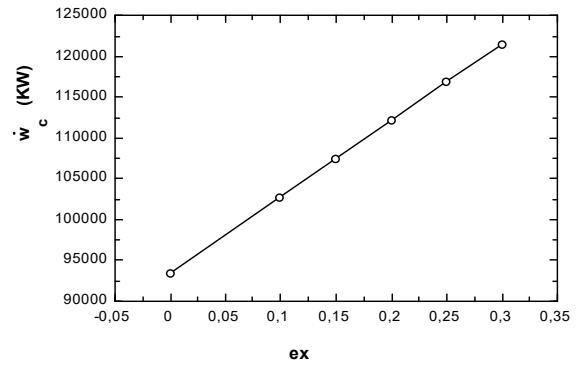

Fig. 8 Variation of compressor power with ex

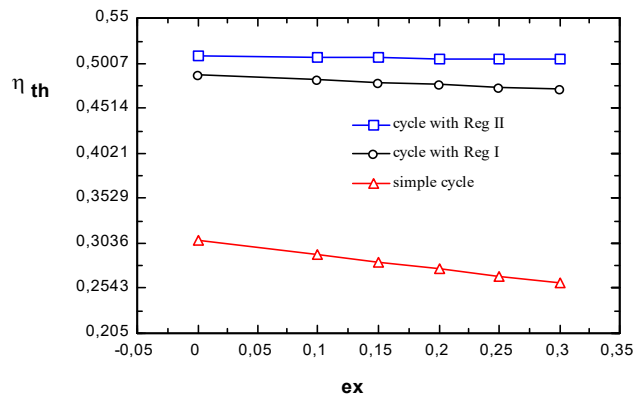

Fig. 9 Variation of thermal efficiencies with ex

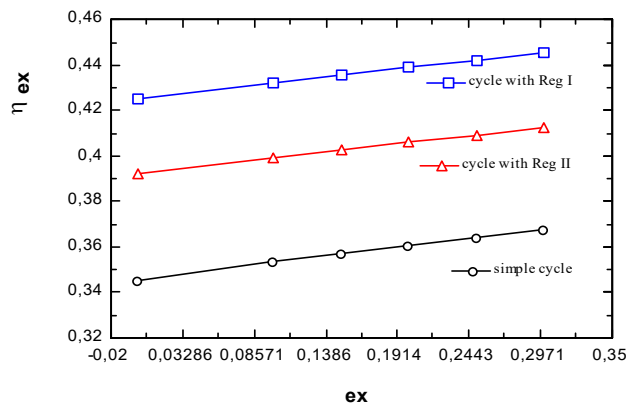

Fig. 10 Variation of exergy efficiencies with ex

For the simple cycle, the thermal efficiency increases with the increase of PR, but for the regenerative cycles, it decreases and the same thing for exergy efficiencies.

Since the energy yield decreases, the reversibility increases and if it increases the irreversibility decreases as it is shown in Fig. 14.

4. Variation of Geometric Parameters

The geometric parameters of the heat exchangers may also influence the efficiencies of the regenerative cycles. In fact, any variation of the design parameters of channels leads to a variation of the overall heat transfer coefficients, the total heat

exchange areas, and the pressures drop, which affects the cycles efficiencies.

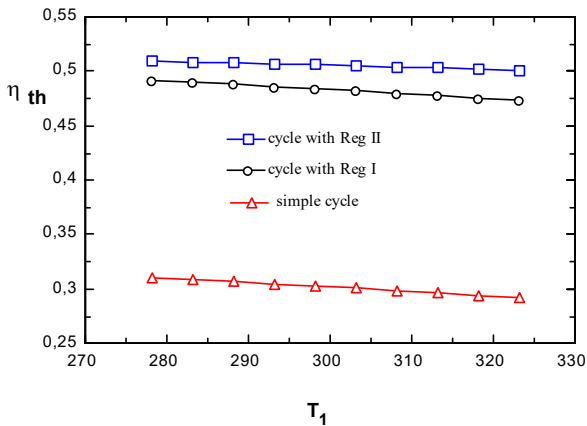

Fig. 11 Variation of thermal efficiencies with  $T_1$

The overall heat transfer coefficient decreases substantially with the increase of the ratio Y/X due to the change attributed to the fluid flow regime through the channels of exchanger. Indeed, when the ratio decreases, the fluid velocity increases, which increases the turbulence and subsequently promotes the

exchange of heat, and thus, the overall heat transfer coefficient increases. We can also show the variation of the thermal efficiency with Y/X in Fig. 16. The reduction of Y/X favors a greater exchange surface and a greater heat transfer, which improves efficiency of the regenerator, thus increasing cycle efficiency.

The pressure drop decreases substantially by increasing the ratio Y/X, which explains the increase of the exergy efficiency with the increase of the ratio in Fig. 18.

When the exergy efficiency increases, the irreversibility decreases as it is shown in Fig. 19. The same thing is also valid for the second regenerator. The overall heat transfer coefficient decreases substantially by increasing h due to the change attributed to the fluid flow regime through the channels of exchanger.

The reduction of h favors a greater exchange surface and a greater heat transfer, which improves efficiency of the regenerator, thus increasing cycle efficiency as it is shown in Fig. 21.

The pressure drop decreases substantially by increasing h, which explains the increase of the exergy efficiency with the increase of h and the decrease of irreversibility as it is shown in Figs. 22 and 23.

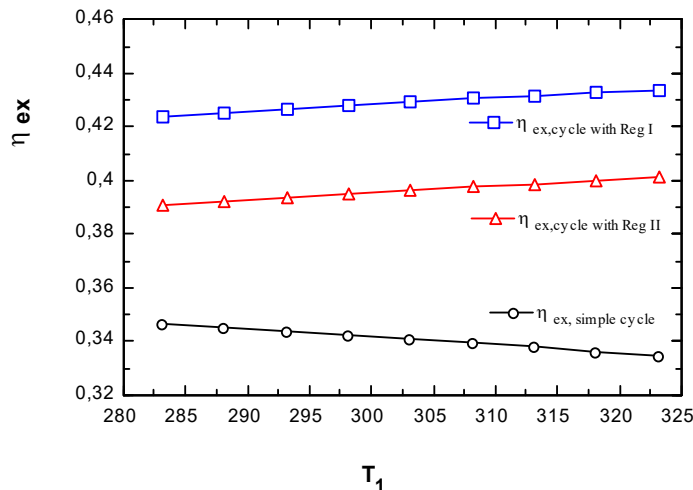

Fig. 12 Variation of exergy efficiencies with  $T_1$

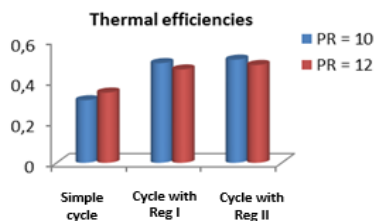

Fig. 13 Variation of thermal efficiencies with PR

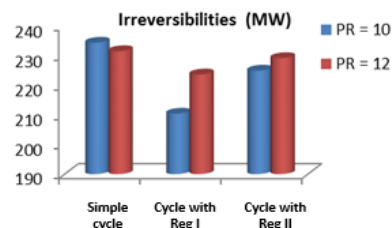

Fig. 14 Variation of irreversibilities with PR

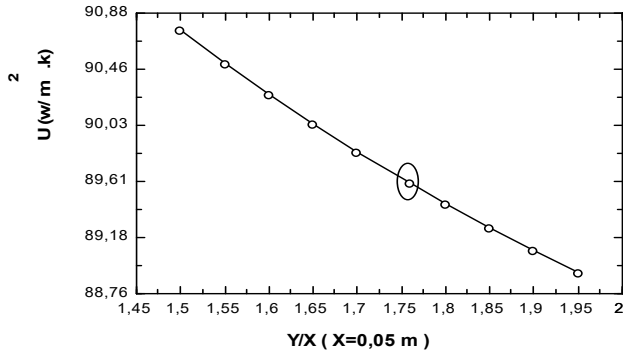

Fig. 15 Variation of overall heat transfer coefficient with Y/X

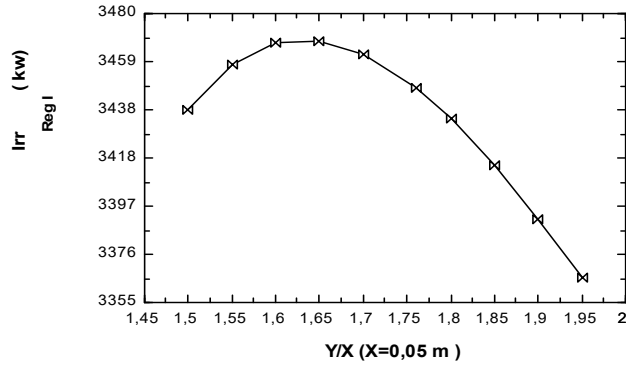

Fig. 19 Variation of irreversibilities with Y/X

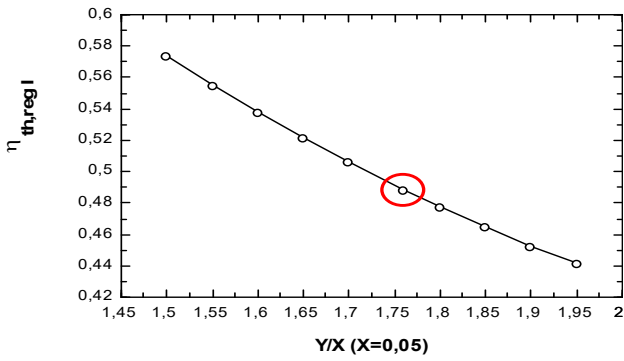

Fig. 16 Variation of thermal efficiency with Y/X

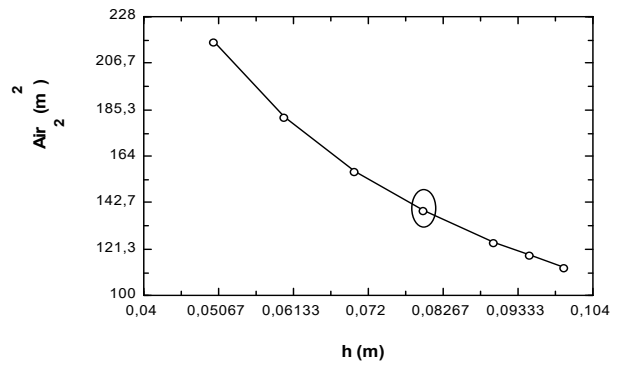

Fig. 20 Variation of exchange area with h

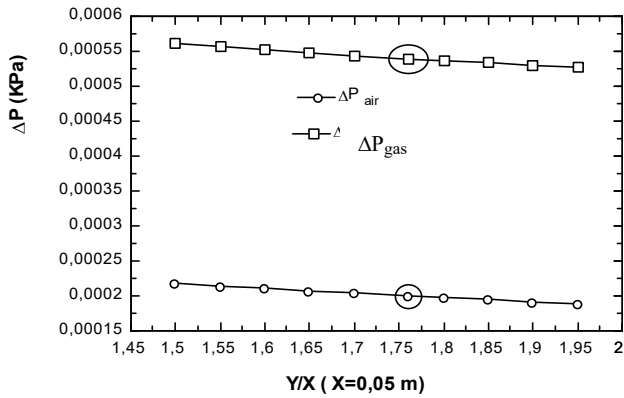

Fig. 17 Variation of pressure drop with Y/X

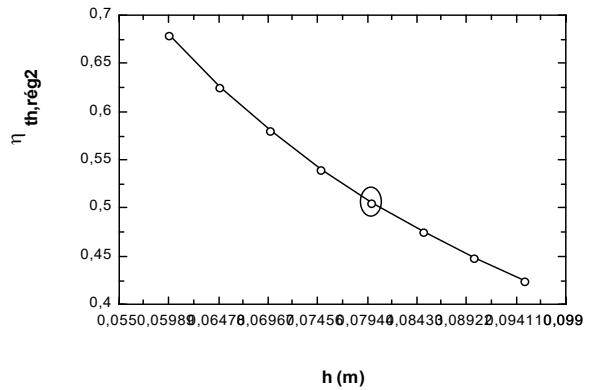

Fig. 21 Variation of thermal efficiency with h

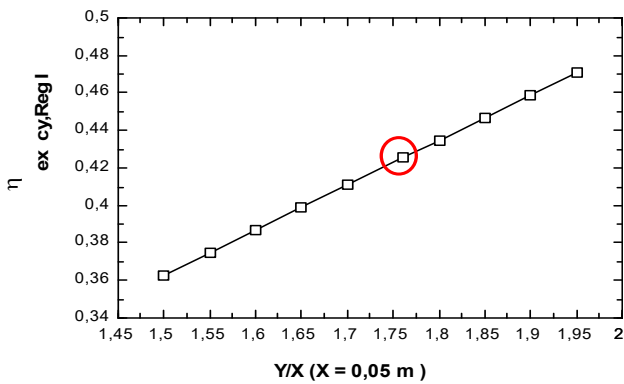

Fig. 18 Variation of exergy efficiency with Y/X

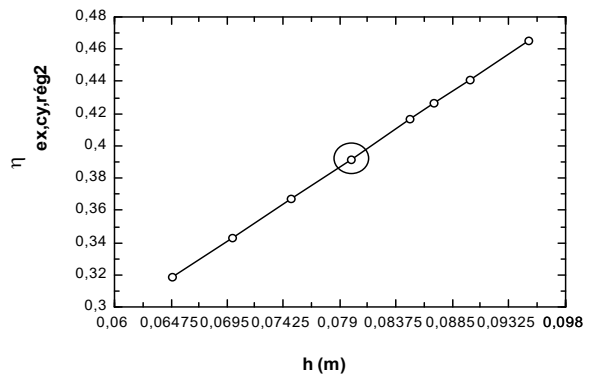

Fig. 23 Variation of exergy efficiency with h

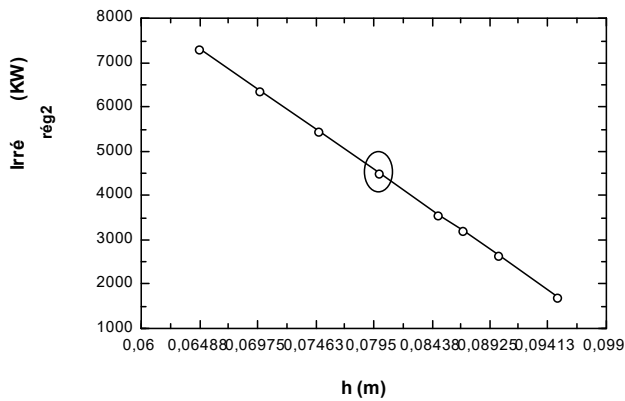

Fig. 24 Variation of irreversibility with h

## VII. CONCLUSION

A numerical simulation of a GT cycle with two regenerator designs is carried out. A program in EES software is developed. This study determines the influence of different operational parameters on the thermal and exergy efficiencies of the cycles such as ambient temperature, excess air, the pressure ratio, and the design parameters of the studied regenerators. The results obtained showed that regenerators have a capacity of an important heat exchange, which increases the cycle efficiencies (thermal and exergy). Conceptual variables of the studied regenerators have a significant influence on the performance of the cycle and the overall heat transfer coefficient air-gas. The second regenerator has an important effectiveness and then provides a greater thermal efficiency than the first one but it has also a greater pressure drop which leads to an irreversibility more important.

## REFERENCES

- [1] C.M. Soares, Gas Turbine in Simple Cycle & Combined Cycle Application. The Gas Handbook, ASME.USA, 2006.
- [2] AshockKumar, S S Kachhwaha and R S Mishra, Thermodynamics Analysis of a Regenerative Gas Turbine. *Cogeneration Plant, Journal of scientific and Industrial Research*, vol 69, pp 225-231, March 2010.
- [3] Alaandro Franco, Claudio Casarosa, *On some Perspective for Increasing The Efficiency of Combined Cycle Power Plants. Applied Thermal Engineering*, Vol.22, pp 1501-1518, 2002.
- [4] A. Cihan, O. Hacıhaafizogluo, K. Kahvesi, *Energy- exergy Analysis and modimization suggestions for a combined-cycle power plant. Int.J Energy Res* 2006; 30:115-26.
- [5] MJ. Ebadi, M. Corj-Bandpy, *Exergetic analysis of gas turbine plants. Int J Exergy* 2005; 2(1):31-9.
- [6] P.Frank, Incropera, P. David, De Witt, *Fundamentals of Heat and man transfer Handbook*, Third Edition, Chapter 11.