

An Experimental Study on the Optimum Installation of Fire Detector for Early Stage Fire Detecting in Rack-Type Warehouses

Ki Ok Choi, Sung Ho Hong, Dong Suck Kim, Don Mook Choi

Abstract—Rack type warehouses are different from general buildings in the kinds, amount, and arrangement of stored goods, so the fire risk of rack type warehouses is different from those buildings. The fire pattern of rack type warehouses is different in combustion characteristic and storing condition of stored goods. The initial fire burning rate is different in the surface condition of materials, but the running time of fire is closely related with the kinds of stored materials and stored conditions. The stored goods of the warehouse are consisted of diverse combustibles, combustible liquid, and so on. Fire detection time may be delayed because the residents are less than office and commercial buildings. If fire detectors installed in rack type warehouses are inadaptable, the fire of the warehouse may be the great fire because of delaying of fire detection. In this paper, we studied what kinds of fire detectors are optimized in early detecting of rack type warehouse fire by real-scale fire tests. The fire detectors used in the tests are rate of rise type, fixed type, photo electric type, and aspirating type detectors. We considered optimum fire detecting method in rack type warehouses suggested by the response characteristic and comparative analysis of the fire detectors.

Keywords—Fire detector, rack, response characteristic, warehouse.

I. INTRODUCTION

AS the industry becomes larger and more sophisticated, the amount of goods demanded by consumers is increasing and the variety of them is also becoming more diverse. Recently, a rack-type warehouse which can efficiently use a narrow space by mounting a vertically rack is rapidly increasing. These warehouses generally have a high floor height and various kinds of stored products, and the arrangement condition is complicated. Therefore, it is difficult to detect fire properly when installing a fire detection system like general building in rack-type warehouses. In addition, since many electric facilities such as motors, electric wires, and control devices are installed in the automated rack-type warehouse, there is a risk of ignition due to improper management of electric facilities. In most of the warehouses, there are many difficulties in fire-fighting activity because of narrow space, high fire load, and so on [1]-[3]. A number of fire detection studies have been researched to reduce fire in warehouses [4], [5]. However, researching method of exact fire detection in rack-type warehouses is still a major challenge in

fire detection. So, there is a need for an optimal method to detect fire early in the rack-type warehouses.

In this study, we analyze the response characteristics of various fire detectors and the temperature distribution characteristics of the height of each rack through fire experiments for heat and smoke flow which can occur in the warehouse fire. The fire experiment is conducted to real scale rack structure and various fire detector installed in rack structure currently in use. As a result of experiment, the optimum installation of fire detector is suggested in rack-type warehouses.

II. FIRE EXPERIMENT

We constructed a rack system of actual size in a warehouse and analyzed the response characteristics of fire detectors for heat and smoke generated by a fire source.

A. Experimental Setup

The rack structure for the experiment is reproduced as a model of the rack structure which is generally installed in Korea. The rack structure was constructed with four levels of ceiling height of 13.5 m, width of 2.5 m, and length of 3.1 m, and a fire detector was installed at each level at the top of each rack after arranging fire source on the floor. The installed fire detectors consisted of fixed temperature spot type detectors (nominal operating temperature 70 °C), rate of rise type detectors (15 °C/min), photoelectric type smoke detectors, flame detectors (UV/IR hybrid type), and air sampling smoke detectors (sensitivity setting value: 1%/m).

The spot-type detectors are installed with a total of 45 detectors (i.e., 1 to 9 detectors at 1 level, 10 to 18 detectors at 2 levels, 19 to 27 detectors at 3 levels, 28 to 36 detectors at 4 levels and 37 to 45 detectors at 5 levels (ceiling)). The flame detector was installed in the center of the ceiling to check the response characteristics of the viewing angle obstacle caused by the items loaded in the rack type warehouse. And the flame detectors were tested to be divided into the cases where the flame is visible within the viewing angle and the flame is not visible due to the product. Fig. 1 shows a schematic diagram of such a fire detector installation.

To measure the temperature, 0.65 mm diameter K-type thermocouples were installed at 45 locations in the same position of the spot-type fire detectors, and we used a data recording device (GRAPHTEC midi LOGGER GL820, Korea). The combustibles used for the fire experiment were those specified in ISO 7240-9 [6]. In order to analyze the response

Ki Ok Choi is with the Fire Insurers Laboratories of Korea, 12661 Korea (phone: +82-10-5141-8449; fax: +82-31-887-6660; e-mail: kochoi@kfpa.or.kr).

Sung Ho Hong is with the Fire Insurers Laboratories of Korea, 12661 Korea (phone: +82-10-2487-1219; fax: +82-31-887-6660; e-mail: hsho@kfpa.or.kr).

characteristics of the heat detectors, n-heptane was used as a typical combustible material of the oil fire and in order to

analyze the response characteristic of the smoke detectors, cotton was used as typical combustible materials.

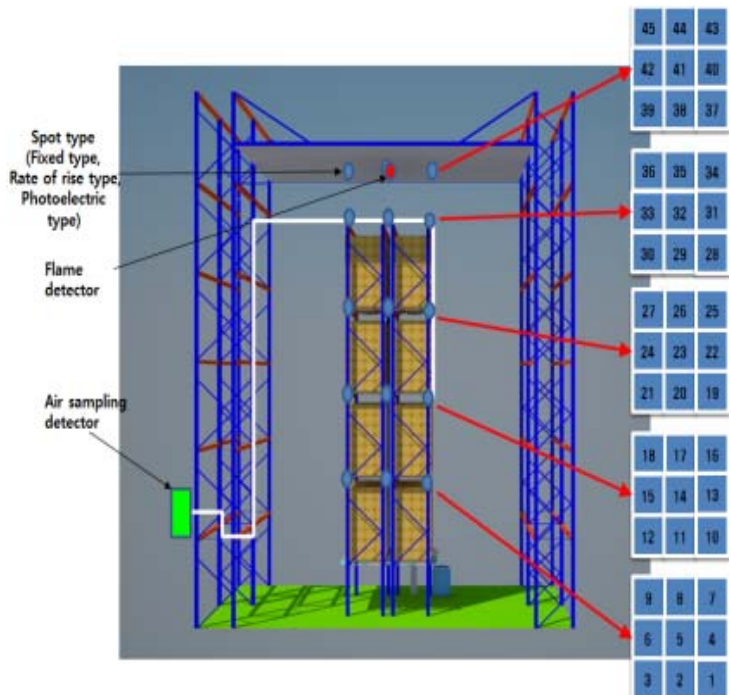

Fig. 1 Schematic of fire detector arrangement

B. Experimental Method

The smoke flow experiment is conducted in order to simulate the smoldering fire which generates high amount of smoke, and the response characteristics of smoke detectors is analyzed. 90 cotton wicks of length 80 cm and weight 3 g are used as shown in Fig. 2 and mounted above an incombustible plate and then ignited by the igniter to be continuously smoldering at the lower end of each wick. The position of the fire source is centered, and detector operating time was measured from the moment when the entire cotton wick was ignited.

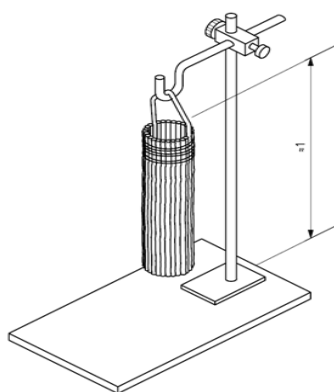

Fig. 2 Arrangement of cotton wicks

In the case of n-heptane, 650 g of n-heptane having a purity of 95% or more was poured into a square steel tray of 33 cm

(width) × 33 cm (length) × 5 cm (depth) and we confirmed the response characteristics of fire detectors after igniting by an igniting bar.

III. RESULTS AND ANALYSIS

Fig. 3 shows the scene of the smoke flow experiment by cotton. It can be seen that a large amount of smoke rises to the top without flames. In the warehouse, a variety of combustibles are loaded, but except for the oil combustibles, general combustibles that generate smoke and heat are stored. Therefore, in order to detect the fire early in the warehouse, as shown Fig. 3, it is important to detect early the occurrence of smoke at the fire.



Fig. 3 The cotton wick fire

This smoke flow characteristic shows that the fire detectors are not installed at each rack level, and even if smoke detectors are installed at certain rack level, the purpose of detecting the early fire can be achieved. Fig. 5 is the result of measurement of smoke concentration over time, and the fastest smoke detectors are in the middle of 4th, 5th, 6th, etc. at rack 1 level.

As a result of the smoke flow test, assuming that the fire is generated in the lower part of the rack, the smoke in the initial stage of the fire moves horizontally to outside of the box through the bottom of combustible boxes (see Fig. 4). In particular, more smoke was found to rise to the top of outside in the rack than to the top of the central flue.

Fig. 5 represents the time taken to rise to the highest detector detection concentration of 20%/m among the fastest detectors at each rack level in terms of early fire detection.



Fig. 4 Smoke flow by cotton fire

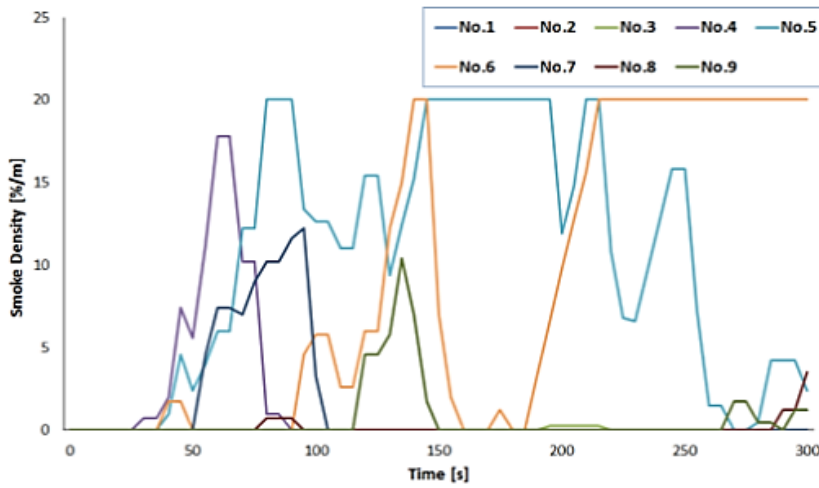

(a)

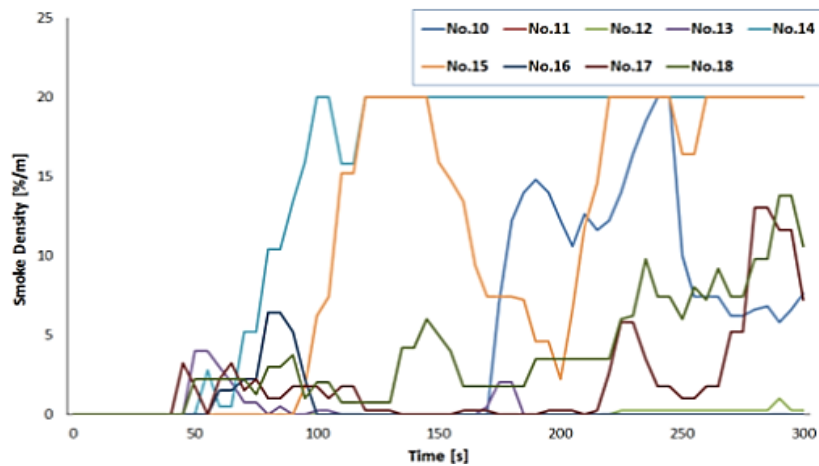

(b)

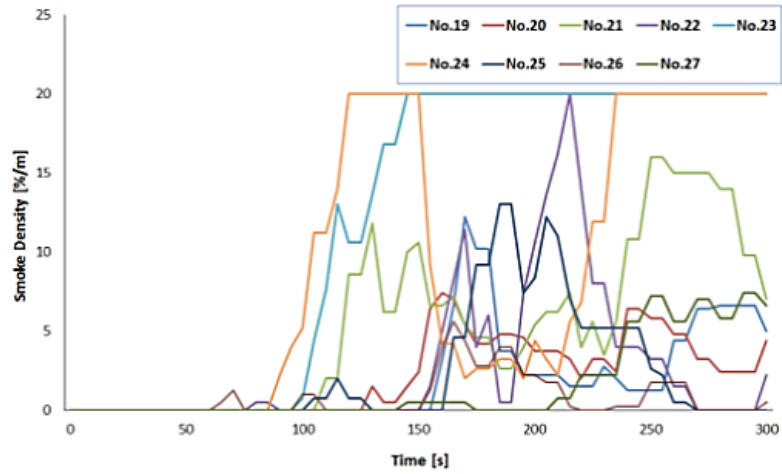

(c)

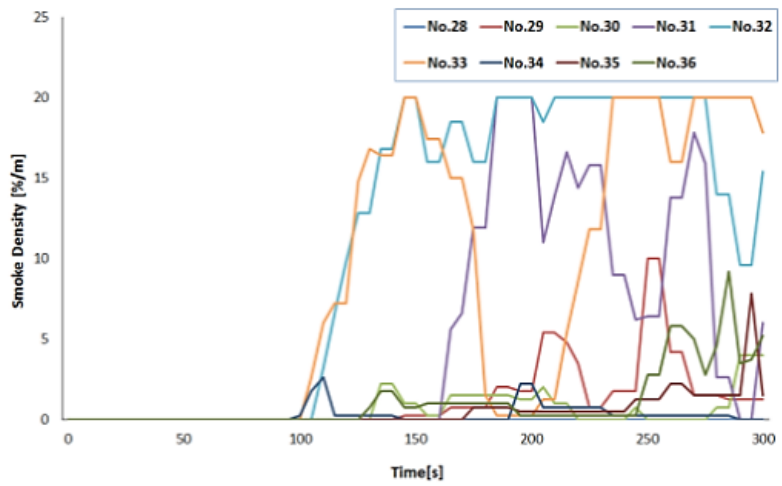

(d)

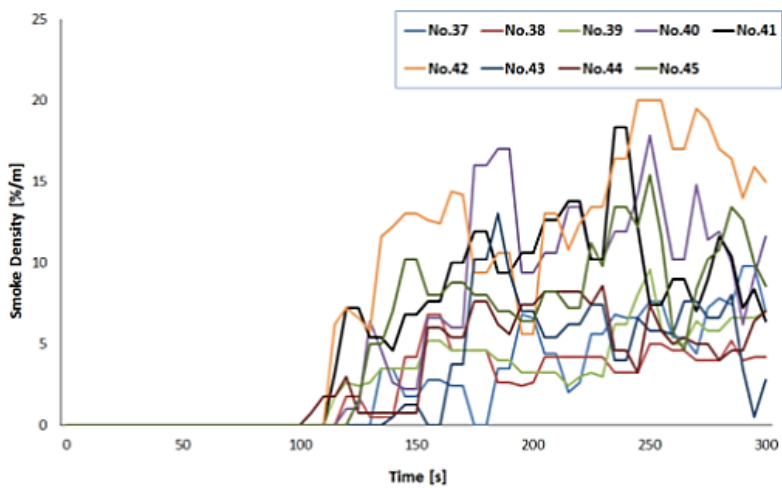

(e)

Fig. 5 Smoke density according to time for each rack level due to smoke generated from cotton wicks (a) Smoke density at 1st level (smoke detectors: no.1 ~ no.9), (b) Smoke density at 2nd level (smoke detectors: no.10 ~ no.18), (c) Smoke density at 3rd level (smoke detectors: no.19 ~ no.27), (d) Smoke density at 4th level (smoke detectors: no.28 ~ no.36), (e) Smoke density at 5th level (smoke detectors(ceiling): no.37 ~ no.45)

As one can see in Fig. 6, one can know that one needs to install a spot-type smoke detector at the 3rd level to detect a fire in 2 minutes. In addition, it was found that the fire detectors at the 4th level could detect fire early at 2 minutes and 25 seconds. These results indicate that sufficient early fire detection objectives can be achieved without installing a detector at each rack level. Of course, this conclusion is based on the response characteristics in the prescribed fire source, so the detector response characteristics may vary depending on the type and size of the fire source. Because the rack-type warehouse real fire usually has faster characteristics than this experiment, the response characteristics of real fire in the rack-type warehouse are faster than the test results. Therefore, it is considered appropriate to install the spot-type smoke detector at every 4 levels in order to detect the fire in the actual rack-type warehouse at an early stage. In the future, it is necessary to analyze the fire detection position more optimally through the fire test of the combustible material stored in the actual racks at the installation position of each level.

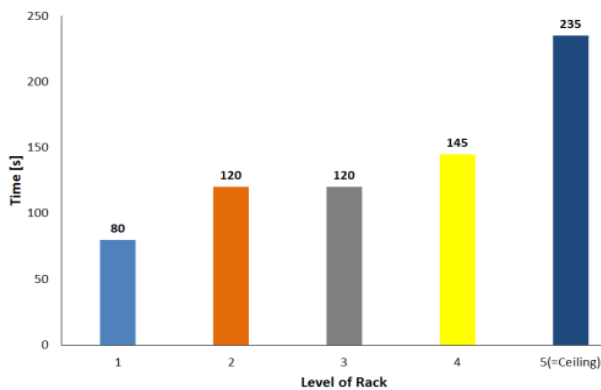

Fig. 6 The time required to reach the maximum smoke density

Fig. 7 shows the heat flow experiment with n-heptane, which shows a combustion scene with generating a constant flame. The maximum heat release rate of n-heptane burned in a 30 cm x 30 cm square container generates about 150 kW (measured by a calorimeter). The temperature distribution at each point by the heat generated is shown in Fig. 8.

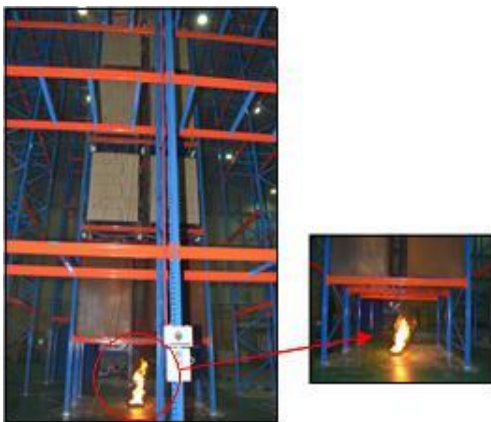

Fig. 7 The n-heptane fire experiment

Although it is a natural result, it can be seen that the closer to the fire source the higher temperature is formed and the rate of temperature rise is higher. Such a rapid temperature increase rate makes the operation of the rate of rise type detector faster, and in the case of a fire with a flame burning such as oil fires, a rate of rise type detector or a flame detector is more useful for detecting an early fire in a rack-type warehouse than a smoke detector.

Fig. 8 shows the temperature distribution over time for each rack level due to heat generated from n-heptane fire. As seen from Fig. 8, the temperature distribution at the point located in the center was the highest where the fire source is at the center of the rack. In particular, if detectors are not exposed to the central fire source, one can see that there is no temperature rise at all, which means that heat detectors can only work if they are exposed directly to the heat source. For installing fire detectors in the center of rack, many experiments and appropriate engineering approaches are needed.

Fig. 9 is the temperature rise rate at the point where the maximum temperature of each rack level is indicated. The temperature rise rate was considered for 2 minutes concerning the early fire detection. As shown in Fig. 9, it was appeared that there was very high temperature rise rate of 39.6 °C/min for 1st level, and 20.4 °C/min for 2nd level, so these results exceeded the temperature rise rate of rate of rise type detectors (2 class, 15 °C/min). Also at 3rd level, the temperature rise rate increase was 12.5 °C/min. Based on these results, it can be seen that the 1 class detector can be installed at every three levels, and 2 class detector can be installed at every two levels when a rate of rise type detector is installed at the middle level of the rack, assuming that the heat is directly exposed to detectors. However, this conclusion is the result of experimenting with a limited fire source, so it is rather difficult to generalize it to all rack-type warehouses. The proper mounting position of the rate of rise type detector at the middle level of the rack needs to be determined through more experiments and analysis.

TABLE I
THE RESULTS OF RESPONSE TIME FOR HEAT DETECTOR

Rate of rise type		Fixed temp. type		Air sampling type	Flame Detector
Detector no.	Response time [s]	Detector no.	Response time [s]	Response time [s]	Response time ^a [s]
23	92				
5	196	5	249	207	1
13	212				

a: The response time is in case of flame visible

Table I shows the detector response times for heat/smoke from n-heptane fires, and it shows that the heat detectors directly exposed to the fire source are operating well. In the case of a rate of rise type detector, the detector at the center of the 3-level was operated first, probably because the air flow around the detector at the 3-level center was more suitable for the detector operation as the thermoform formation increased. In the case of the fixed temperature type detector, only one level detector at the upper part of the fire source was operated and the operation time was much slower, which is not suitable

for the detection of early fire in the rack-type warehouse.

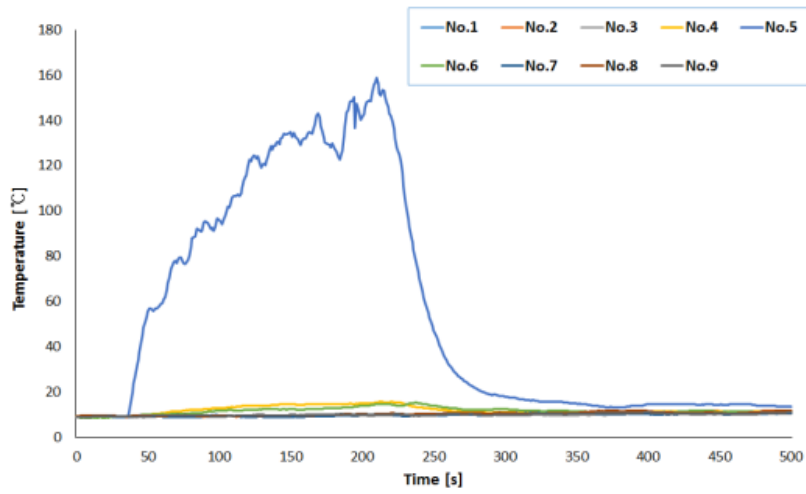

(a)

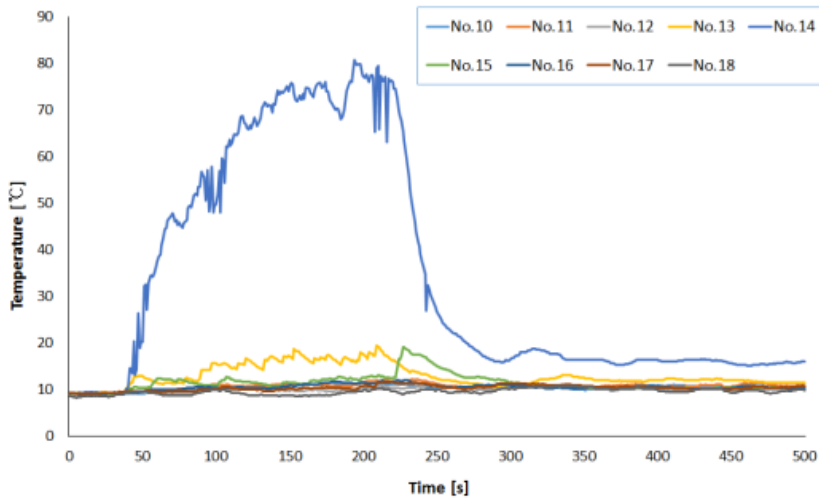

(b)

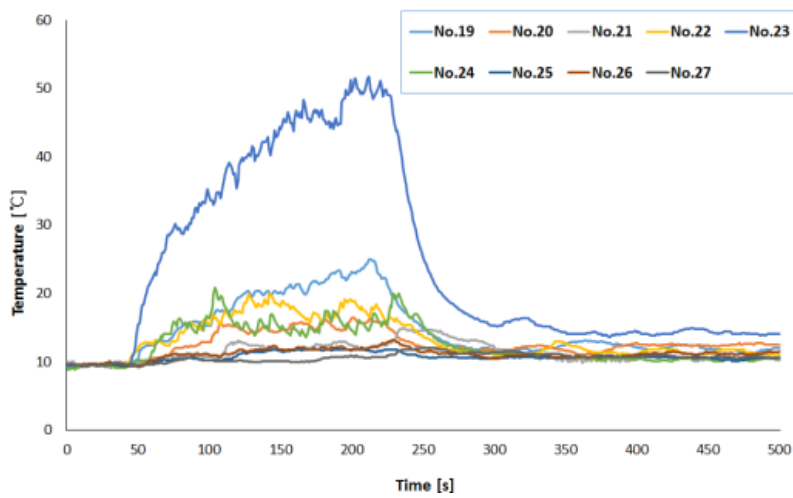

(c)

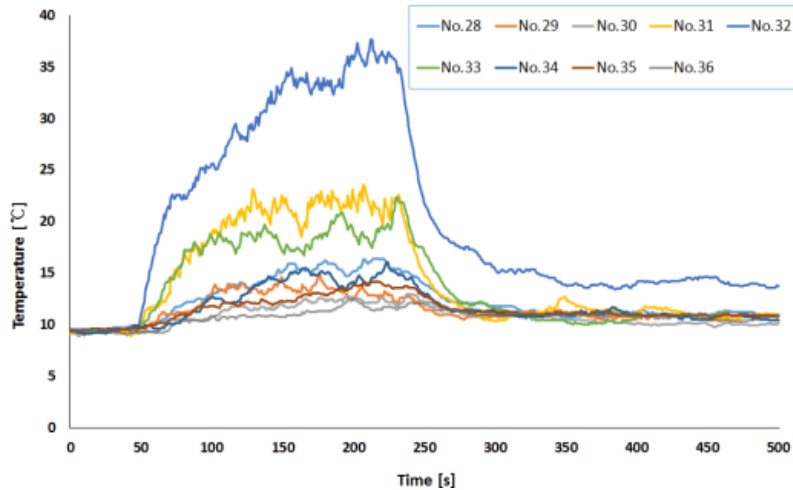

(d)

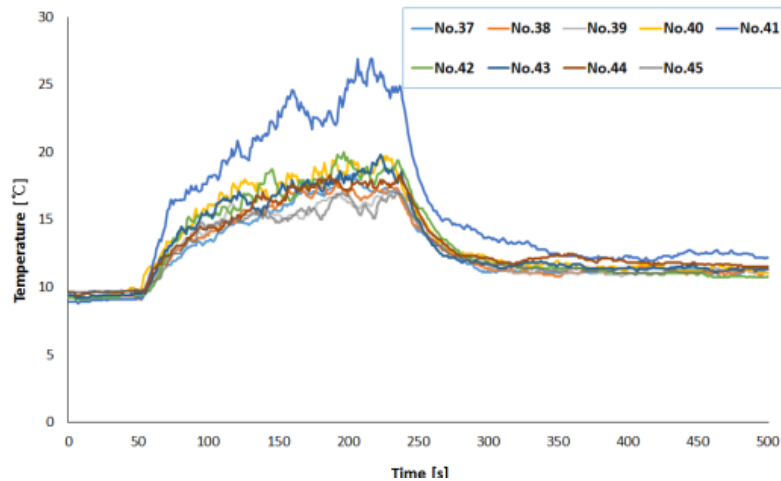

(e)

Fig. 8 The temperature distribution according to time for each rack level due to heat generated from n-heptane fire. (a) The temperature distribution at 1st level (no.1 ~ no.9), (b) The temperature distribution at 2nd level (no.10 ~ no.18), (c) The temperature distribution at 3rd level (no.19 ~ no.27), (d) The temperature distribution at 4th level (no.28 ~ no.36), (e) The temperature distribution at 5th level (ceiling, no.37 ~ no.45)

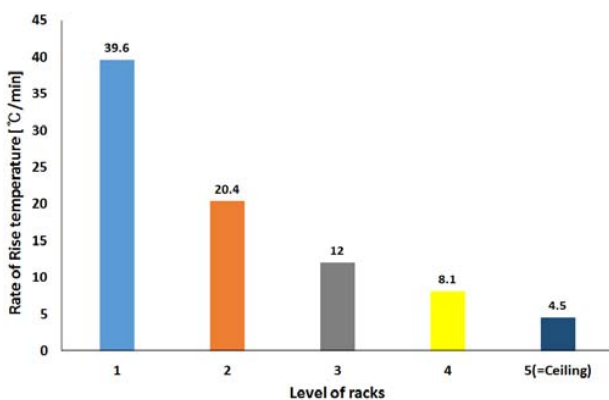

Fig. 9 The rate of temperature rise per minute

As shown in Table I, the flame detector immediately reacted when the flame was seen, but did not react when the flame was

not visible. Considering this response characteristic, it is necessary for the flamed detector to detect a fire in combination with another detector, rather than detecting a fire alone, in order to detect an early fire in a rack-type warehouse. The air sampling type detector detected early at the smoke test, but in the case of n-heptane, the detector showed a slow response characteristic as shown in Table I. In the case of n-heptane fire, smoke is also generated, but since it is a fire that generates a lot of heat, it is considered that the rate of rise type detector has a quicker response characteristic. However, if the sensitivity of the air sampling type detector is set to a lower value, this reaction time may appear faster, but unwanted-alarm problems may occur. Therefore, it is possible to detect the fire of the rack type warehouse early by using the air sampling type detector, but it may not be effectively used to detect the fire of the rack type warehouse unless the problem of the unwanted alarm problem is solved.

IV. CONCLUSION AND FURTHER RESEARCH

This study is an experimental study to find an optimal fire detection method for early detection of a rack-type warehouse fire. In this study, we constructed a rack structure with the same size as the actual one and installed a fire detector to analyze the response characteristics of each fire detector. As a result, the following conclusions are obtained under the experimental conditions in this study.

- 1) In the case that the heat detectors are installed at the intermediate level of the rack to detect the early fire of the rack-type warehouse, rate of rise type detectors may be installed at every two levels for early detecting, and fixed temperature type detectors are not suitable for detecting early fire in a rack-type warehouse.
- 2) In order to detect early fire in a rack-type warehouse, it was found to be best to install spot-type smoke detectors at the middle level of the rack. In this case, if the aimed detecting time is in 2 minutes, it is appropriate to install spot-type smoke detectors at every three levels, and if the aimed detecting time is in 3 minutes, it is appropriate to install spot-type smoke detectors at every four levels.
- 3) Air sampling type detectors can detect fire early in a rack-type warehouse by adjusting the sensitivity of the reaction, but the unwanted alarm problem must be solved first.
- 4) The flame detector showed the response characteristic to react instantly when the flame was seen; however, if the flame is obstructed by the obstacle, it cannot detect the fire. If the flame detector is applied to the rack-type warehouse, it should be installed in combination with other detectors to achieve the purpose of early fire detection.

The result of analyzing the response characteristics of the fire detectors by the heat/smoke behavior by the fire source specified above, and the response characteristic of the fire detectors may be different depending on the kind of the fire source. In the future, additional actual room fire testing and analysis that loads and burns the combustibles in the rack-type warehouse is needed.

ACKNOWLEDGMENTS

This research was supported by the Fire Fighting Safety & 119 Rescue Technology Research and Development Program funded by the Ministry of Public Safety and Security ((MPSS-Fire Safety-2015-67).

REFERENCES

- [1] Y. S. Kim, "A Study on the Application of Fire Prevention Facilities to Increase Fire Responsiveness of Rack-type Warehouses", Pusan National University, 2013.
- [2] W. H. Kim, Y. J. Lee, " An Improvement of Fire Safety Code for Rack-Type Warehouse in Korea", Journal of Korean Institute of Fire Science & Engineering, Vol.28, No.6, pp.69-75, 2014.
- [3] D. H. Kim, "A Study on the Establishment of the Fire Load by Building Occupancy", Konkuk University, 2003.
- [4] D. T. Gottuk, Fire Detection in Warehouse Facilities, NIST, 2012.
- [5] Xtrails Ltd., Warehouse Fire Tests Demonstration - ASD vs Point (spot-type) vs Beam Detectors, Case Study, 2008.
- [6] ISO 7240-9, Fire detection and alarm systems - Part 9: Test fires for fire detectors, 2006.