

Fuzzy Based Particle Swarm Optimization Routing Technique for Load Balancing in Wireless Sensor Networks

S. Balaji, E. Golden Julie, M. Rajaram, Y. Harold Robinson

Abstract—Network lifetime improvement and uncertainty in multiple systems are the issues of wireless sensor network routing. This paper presents fuzzy based particle swarm optimization routing technique to improve the network scalability. Significantly, in the cluster formation procedure, fuzzy based system is used to solve the uncertainty and network balancing. Cluster heads play an important role to reduce the energy consumption using particle swarm optimization algorithm, the cluster head sends its information along data packets to the heads with link. The simulation results show that the presented routing protocol can perform load balancing effectively and reduce the energy consumption of cluster heads.

Keywords—Wireless sensor networks, fuzzy logic, PSO, LEACH.

I. INTRODUCTION

WIRELESS sensor network (WSN) is used to monitor wide coverage area [1]. Features manipulating sensor network intend are blunder forbearance, reachability, working atmosphere, sensor network hierarchy, broadcast medium and energy utilization [16]. Hence, the important challenge for WSN is load balancing in the network. Several routing protocols have been proposed to increase the WSN lifetime [5]. Clustering routing protocols are developed by using a large amount of neighboring nodes which consist of cluster nodes and cluster heads (CHs). Clustering routing protocols can have the improved scalability, reduced load, reduced power consumption [8]. CHs of high level network are the combination of all the cluster members of a top level network with the communication to the Base Station of the WSN [31]. Low Energy Adaptive Clustering Hierarchy (LEACH) protocol has been proposed for clustering routing technique. The common path of LEACH is to improve the lifetime of a WSN by reducing the power consumption of the sensor nodes [6]. To solve the problem, the various levels of improved algorithms are implemented to increase the CH distribution [9].

Balaji S. is Associate Professor with the Department of Computer Science and Engineering, Francis Xavier Engineering College, India (e-mail: sbalajiphd@gmail.com).

Golden Julie is an Assistant Professor, Department of Computer Science and Engineering, Anna University, Chennai, India (e-mail: goldenjuliephd@gmail.com).

Prof. Dr. M. Rajaram is the Vice-Chancellor, Anna University Chennai, India (e-mail: rajaramget@rediffmail.com)

Harold Robinson Y. is Associate Professor with the Department of Computer Science and Engineering, SCAD College of Engineering and Technology, India (e-mail: yhrobinphd@gmail.com).

Multi-hop routing protocols are used to minimize the energy consumption for data communication [12]. In this initial phase, the node can generate a pseudo-random number from 0 to 1 [2]. LEACH-C is the centralized algorithm that means all CHs are formed by the base station [4]. An established Quality of Service scheme has been premeditated, where the neighbor assortment algorithm and the path assortment algorithm are used to choose a path by vehicles which are likely to move at comparable speeds and in the direction of comparable directions [13]. An innovative routing protocol is used to generate the channels with non-evaporation period for routing, and then it attempts to diminish packet failure. Due to evaporation reuse, the path with some protection strategies is used to enlarge the throughput in WSN [14].

Snooze and energetic of nodes will occasionally assist to preserve their power for more time. The occurrences happening in any ingredient of the network must be recognized by the nodes [15]. In I-LEACH, at the outset, the possibility based assortment criterion for a CH was substituted with conception of remaining energy [17]. Enhanced Cluster Based Key Management Algorithm is used to minimize the end-to-end delay by the way of increasing the throughput. The routing transparency is condensed and then it extends the network existence. Replication results demonstrated that the broadcasting technique is used to decrease the jitter by improving the Quality of Service [18]. In a clustering method, the nodes are separated into similar groups. They are frequently based on environmental properties. Each group has a CH and numerous regular nodes. A CH regularly provides the restricted controller for its adjacent cluster nodes [19]. CLENER algorithm [20] affords energy-efficiency by group arrangement using fuzzy logic and CH determination based on a possibility function. The disadvantage is that the foundation position has not been subjected to power limitations and is situated within the sensing meadow. Dominating set algorithm remains the initial node animated with larger amount of erstwhile protocols. Since the dominating set formations of every group of CHs are unswervingly associated to every node, the liveliness of the network is kept by eliminated transitional nodes in WSN [21]. Directional Flooding-based Routing (DFR) is used to increase the network connectivity [22]. The sink node is employed to acquire an invalidate path for the destination node and to transmit acknowledgement for the preceding demand. The generously proportioned maximum value will stay behind the route release [57].

Depth Based Routing protocol (DBR) [23] is used to choose the power, environmental or spatial data. In this technique, the sagacity data from the surroundings are routed to the regular descends [51].

A tree-based data fusion clustering routing algorithm (TBDFC) is proposed to minimize the consumed energy in WSNs [24]. Routing path is additionally recommended and calculated using meta-heuristic iteration based Bat algorithm [25]. The fundamental functioning attitude is based on hydraulic weight available along dissimilar strengths in the sea. Opportunistic routing has been performed to execute the adjacent paths for unappeasable procedure. For up-stream, broadcasting is another level of distributed systems; it is a controlled up-stream related to the planned time of every process of broadcasting that avoids divergence from creature source to the up-stream information, and improve the limited bandwidth utilization [26]. The new algorithm is used to improve Data Base Administrator with the relation of the Interleaved Polling with Adaptive Cycle Time (IPACT) methodology that involves a queue-based preparation scheme [28].

Tree Based Opportunistic Routing (TBOR) discovers a multipath routing scheme to achieve the threshold possibility of high throughput [27]. Geographical routing protocols afford extended detachment data forwarding and superior improvement across the destination [39]; direct to enlarge indicator reduction and packet failure problems in the system [29]. Assortment joining methods are used at the destination node to connect the data from assorted range of divisions [30]. Shifted assortment is the simplest diversity merging method amongst the channel position data of the route under reflection. In [32], the outage presentation is identified for the shifted assortment method in supportive DF communicating network over other related fading network channels. In [34], the supportive system uses switch-and-stay transmit assortment scheme for obtaining the outage possibility in a related fading network channel. In [35], the presentation of a solitary middle node supportive network is calculated using a harmonizing fault method [36].

A most favorable assortment joining method is scrutinized for the supportive system using complete network and an end to end symbol error possibility is calculated by shifting technique [37]. The consequence of association limitation (A_q) is glowing scrutinized for nakagami-m fading channel [38]. In [40], a bit fault possibility and outage possibility are calculated.

In [41], the Quality of Service is improved by using the cooperative system relays. The end to end delay is obtained with controlled and observe technique [43]. Virtual back bone path computation is based on the restrictions like message success rate, communication rate, and greatest connectivity [42], [66].

WSNs are susceptible to numerous hazards. Antagonists are accomplished of conciliating sensor nodes that snoop on information, insert fake information plus dissipate system supplies [33]. Consequently, cryptography methods have been proposed for handling security related problems efficiently in

WSNs [44]. There are numerous constraints in the implementation of cryptography methods in WSNs like storage, broadcasting, performance analysis and also dispensation capacities [48].

Design of cryptography based protocols requires understanding of the constraints and accomplishing sufficient encoding and decoding techniques [51]. Cryptography crashes are determined and evaluated by using the scalable parameters of improvements in WSNs, and such crashes possibly used by opponents [16]. But the substantial dismissal in WSNs escorts to exceptional probable in scheming them for progressing their stipulation of detailed provision regardless of crashes [60]. The organization should be able to acclimatize in narrative way that unanticipated damage when the organization is originally arranged [54].

Confidence establishment amongst nodes is a mandatory for appraising trustworthiness of other nodes since endurance of WSNs is dependent on combined in addition to unquestioning scenery of the nodes [64]. Cryptography in addition to confidence is two tremendously mutually dependent impressions and owing to the mutually dependence, the expressions are used as signatures, when developing protected networks [47]. But, cryptography is not the identical as confidence, the most important distinction being that it is additional complex and has superior overheads [46].

Confidence in WSNs has a momentous ingredient to engage in recreation in construction of systems and appending or reducing sensor nodes from systems, on account of the enlargement of the system, or substituting unreliable nodes in a horizontal in addition to translucent method [45]. The performance of the energetic non-linear schemes for WSNs are involving network arithmetical representations which may be griped in a specialized method by fuzzy logic. Real-time implementations like decision making systems, patterns recognition, control systems and network modeling may implement fuzzy if-then rules [49], [63].

A data-mathematical representation [50] is used for quantitative quantity of expectation in addition to build a new expectation structure with numerous conviction conclusion features. Fuzzy logic regulations calculation process is approved for modernizing node's conviction. [61]. The narrative confidence method proposes elastic in addition to practicable process in routing verdict making, believing both conviction constraints as well as nasty node recognition in multi-agent networks [65]. Performance evaluation was developed for generating effectiveness of trust model as well as multi-case trust improvement in recovering network communication dominance, trust energetic flexibility, malicious nodes recognition, attack confrontation as well as enhancements to network security [62].

In contradiction of previous methods, general experimentations have been developed for calculating effectiveness of the proposed battering resistance of system security [54].

Dissimilar behaviors are created to dissimilar behavioral data to distinguish malicious nodes and recognize their behavior data [52]. The cryptography of WSNs is then

improved by numerous parameters for switching several categories of un-trusted movement. Simulation results showed that the proposed conviction management structure can disconnect ordinary nodes and un-trusted nodes and discriminate dissimilar types of un-trusted nodes [53].

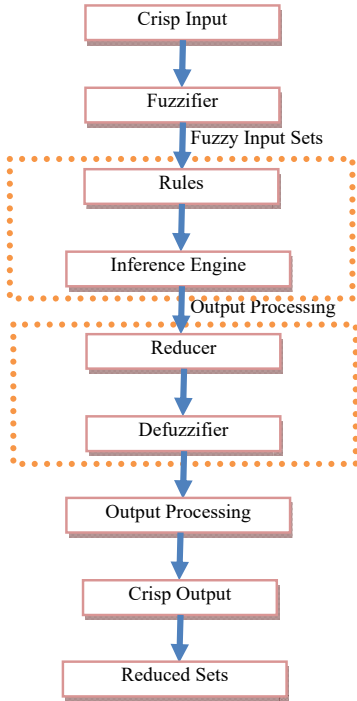

Fig. 1 Architecture of a FLS

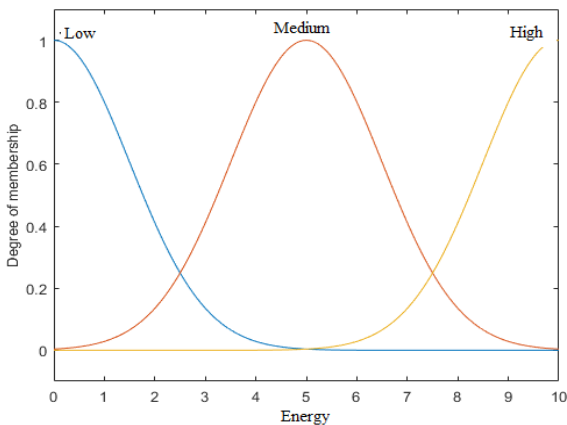

Fig. 2 Membership Function of input variable 'Energy'

On the origin of fuzzy active programming hypothesis, in trusted routing structure, [56] developed a trusted routing protocol that thrusts out untrustworthy nodes for attaining trustworthy route rescue path. A reactive routing algorithm is proposed for generating a lot of confidence links in a route discovery that finds dependable or confidence requisites of network data packets. Experimental results confirmed that the confidence-based routing algorithm is able to achieve the improvements in Packet Delivery Ratio [55], [58]. Confidence

method is a mathematical representation which identifies the estimation of one node by adjacent nodes in the network. In confidence based method, owing to the prejudice of conviction assessments, it has several uncertainties [59].

II. FUZZY BASED PARTICLE SWARM OPTIMIZATION

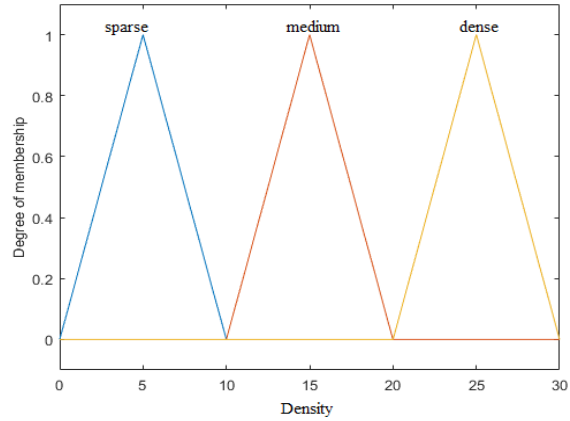

Fig. 3 Membership Function of input variable 'Density'

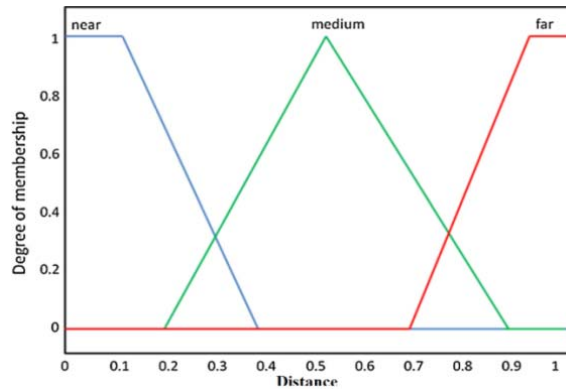

Fig. 4 Membership Function of input variable 'Distance'

Fuzzy based particle swarm optimization clustering routing protocol is implemented to find the CHs and particle swarm optimization is used for multihop routing. Importantly, three issues called residual energy; number of adjacent nodes, and the base station distance are the inputs to calculate the probability. The particle swarm optimization algorithm is used to create a link to all the CHs [10]. The fuzzy set is differentiated with different membership functions [7].

Base Station generates the network with FBPSO algorithm to computer the list of CHs, then finds and transmits control values to every sensor node and every initial node demonstrates the joining cluster based on the factor of distance and transmits control and data packets to their respective CHs.

FLS can compute the natural rules are executable in the system environment. The protocol based on LEACH uses the base station to find CHs based on three parameters. They are Centrality, Adaptation and Power Consumption [3]. If the pseudo-random number is less than the threshold value $\delta(n)$, the node will be the CH in the cluster groups. All the other

nodes can perform their cluster by finding the CH that needs the low energy communication.

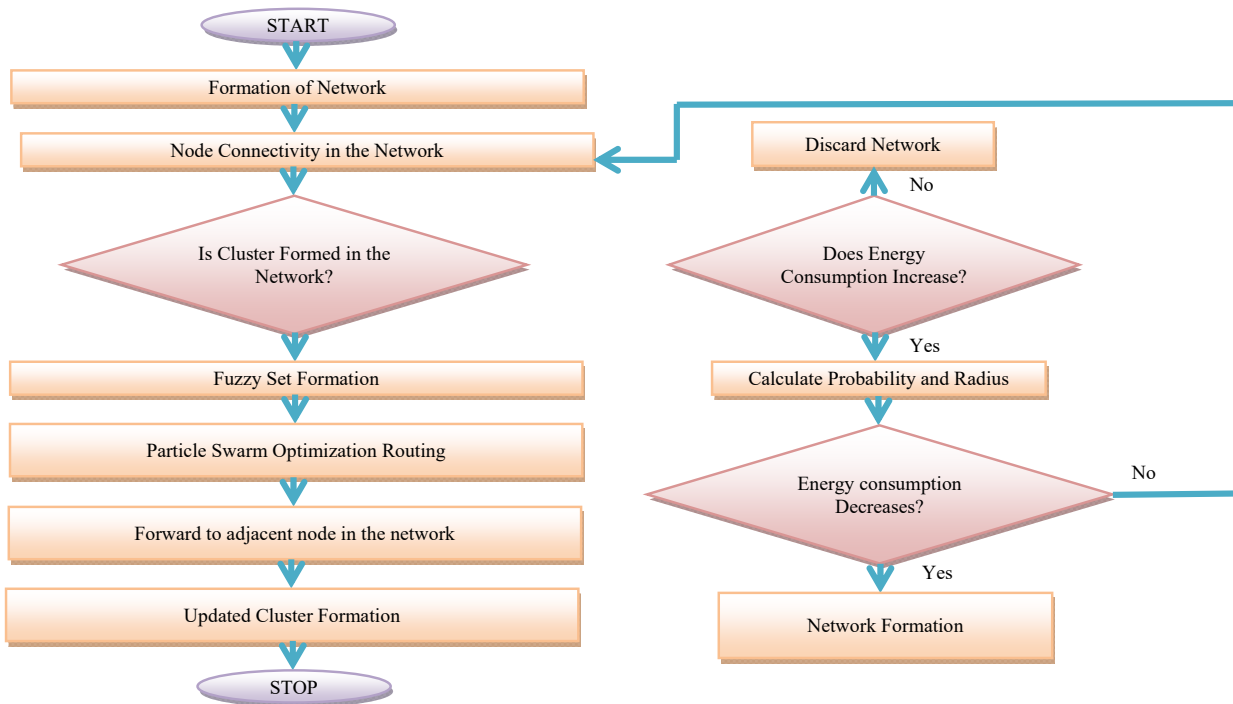

Fig. 5 Flowchart for the Proposed Work

In the second state, the CH can use the TDMA to communicate with the nodes in their clusters [11].

$$\delta(n) = \frac{P_{CH}}{1 - P_{CH} \times \left(g \bmod \frac{1}{P_{CH}}\right)} \quad (1)$$

where P_{CH} is the probability for CH, g is the number of groups and n is the group of sensor nodes.

The Fuzzifier can have every crisp input in the Fuzzy set. The crisp input vector $c' = (c_1', \dots, c_p')$.

$$\sigma_{C_i}(c_i) = 1, \text{ if } c_i = c_i' \quad (2)$$

$$\sigma_{C_i}(c_i) = 0, \text{ if } c_i \neq c_i' \quad (3)$$

The three inputs have the interval [0,1]. Figs. 2-4 demonstrate the membership functions of Energy, Density and Distance.

Let us assume that the input variable Energy as i_1 , the input variable Density as i_2 and the input variable Distance as i_3 . The Output variables are probability as j_1 and Radius as j_2 .

A. Rule

If i_1 is F_1
 i_2 is F_2
 i_3 is F_3

 i_n is F_n
 Then

j_1 is G_1
 j_2 is G_2

$\sigma_{F_i}(c_i)$ and higher membership functions $\sigma_{F_i}'(c_i)$

$$f(i) = \sigma_{F_1}(c_1) \times \dots \times \sigma_{F_p}(c_p) \quad (4)$$

$$f'(i) = \sigma_{F_1}'(c_1) \times \dots \times \sigma_{F_p}'(c_p) \quad (5)$$

Defuzzification using the average of

$$q_j(x) = \frac{q_{j_l}(x) + q_{j_r}(x)}{2} \quad (6)$$

The Extend Output can be calculated as

$$q_{\cos}^i(x) = [q_{ji}(x), q_{jr}(x)] \quad (7)$$

B. Algorithm

Step 1: Compute Probability and Radius
 If Base station receives sensor nodes information, then
 Calculate probability and radius using FLS
 Sensor node (x) is in alive
 $(fx.\text{probability}, fx.\text{radius}) = \text{FLS}(fx.\text{energy}, fx.\text{density}, fx.\text{distance})$

End If

Step 2: Calculate optimized Cluster Node

$$\text{Cocn} = [((xpn - xpd)/n) + 0.5] \quad (8)$$

Step 3: Calculate Path

$$\text{Path} = \text{Sort}([\text{f.probability}], \text{'descending'}) \quad (9)$$

Step 4: Generate CH

Path (i) = initialClusterHead
 increase the Cluster
 if distance of (Path (i), f_j) is less than
 $f_{\text{path}(i)} \times \text{radius}$ then
 f_j is notClusterHead
 increase the value of i
 otherwise f_j is the clusterHead
 If CH (QS =Small and CS=Near and RE=High)
 Then
 Selected CH is extra to optimal cost path to
 Accomplish sink
 If CH (QS =Large and CS=Far and RE=Low)
 Then
 Selected CH is added to below optimal cost path
 So it not selected to reach sink
 Step 5: Routing

For every connection do
 set beginning value $\beta_{i,j}(x) = 1$
 end for
 for every Cluster_Head do
 calculate the O_{ij}
 end for
 while not end do
 for every particle do
 randomly find a Cluster_Head
 for I = 1 to n do
 calculate possibility PO_{ij}
 choose alternate Cluster_Head
 with possibility PO_{ij}
 end for
 end for
 compute the routing path discovery length D_k of the k^{th} particle
 generate the shortest path into short_path_{ij}
 for every connection do
 Change beginning value $\beta_{i,j}(x)$
 end for
 end while
 Choose the shortest path into short_path_{ij}
 Find the alternate Cluster_Head nearest into the Base_Station as
 the new leader
 for every Cluster_Head do
 transmit packet using leader control function
 end for

Step 6: Energy Consumption

The Energy consumed while transmitting the node of x-bits packet
 with the distance can be calculated as

$$\text{Energy_Transmitted}(x, \text{distance}) = \text{Energy_Transmitted_send}(x) + \text{Energy_Transmitted_received}(x, \text{distance})$$

Step 7: Receiving Signal

SE_n: Number of Sensor nodes

SE_{ch}: CH

CF: Cluster shaped

Phase I:

1. for each SE_n to n-1 do
 2. CF_i = {SE₁, SE₂, SE_n}
 3. Choose SE_{ch}
 Transmit information to CH
 4. CF_i (SE₁, SE₂, SE_n) → SE_{ch}
 Transmit information to adjacent CH
 5. SE_{ch} → Adjacent SE_{ch}
 If (Energy_Consumed (SE_{ch} < Energy_Threshold)) then
 select new Sch within CF

Step 8: Network Formation

Let SY be the system where
 SY = {nu, SE_i, PR, CHE, NM}
 nu: Number of Sensor Nodes
 SE_i: Network Sink Node
 CHE: CH
 NM: Network
 nu = nu₁, nu₂, ..., nu_n
 SE_i = sink node count
 PR = PR₁, PR₂, ..., PR_n

Base Station generates the network with FBPSO algorithm
 to compute the list of CHs, then finds and transmits control
 values to every sensor node and every initial node
 demonstrates the joining cluster based on the factor of distance
 and transmits control and data packets to their respective CHs.

The sensor nodes are haphazardly allocated in the network.
 The sensor nodes and the base stations are the motionless of
 hypothesis phase. Sensor nodes are harmonized with energy
 restricted have the identical establishment energy,
 communication path is identical. Nodes have their own data
 such as location of the network node and energy consumption
 so they send to the Base station with particular energy levels
 during the network group stage.

To obtain the resource node's location using a network
 routing by representing the location optimization a_k which
 consumes reduced communication cost. The packet for data
 Communication follows some multihop sequential order.

$$a_i \rightarrow b_{i1} \rightarrow b_{i2} \rightarrow \dots \rightarrow b_{iq} \rightarrow d \quad (10)$$

The communication cost between a_i and d can be obtained
 by creating the network route c_i as cost (a_i, c_i). The
 communication cost optimization solution can be obtained by

$$X_0 = \min \sum_{i=1}^N [p(a_i) \min \text{cost}(a_i, c_i)] \quad (11)$$

Modified cost reduction function given by

$$X = \sum_{i=1}^N p(a_i) \sum_{i=1}^M p(c_i | a_i) \text{cost}(a_i, c_i) \quad (12)$$

The probability distribution function that improves the
 communication cost by

$$G = - \sum_{i=1}^N p(a_i) \sum_{i=1}^M p(c_i | a_i) \log(\text{cost}(c_i | a_i)) \quad (13)$$

Such that

$$X = \sum_{i=1}^N p(a_i) \sum_{i=1}^M p(c_i | a_i) cost(a_i, c_i) = X_0 \quad (14)$$

The remaining energy can be obtained using the cost based function

$$cost(c_i | a_i) = \frac{e^{-\theta \cdot x \cdot cost(a_i, c_i)}}{\sum_k e^{-\theta \cdot x \cdot cost(a_i, c_i)}} \quad (15)$$

Fuzzy Based radius procedure is used to fix the rules for creating the CH selection and distribution. It takes several round, output of the preceding round will be the input for the successor round.

FBPSO can embrace uncertainties outcome from inaccurate inputs and compound rules that are used to select the CHs in the Routing protocol of clusters. Moreover, in this paper, we need to utilize a FLS to compact with uncertainties in WSNs.

Table I demonstrates the Possibility of Chance of the three parameters Distance, Density and Energy based on Competition Radius Process using Fuzzy Inference Rule.

C. Tailback Node Selection

```

tailback_Node_Selection(Tb)
Max_Energy = -∞;
tailback_node = NULL;
for x = 1 to n
    
```

```

    if branch_node(i)=NULL then prolong;
    else
        calculate max_dist(max_dist(x), max_node(x));
        compute energy_consumed (energy(x));
        if energy(x) > Max_Energy
            Max_Energy = energy(x);
            tailback_node = x;
        end if
    end if
end for
return tailback_node;
    
```

III. PERFORMANCE EVALUATION

The solution for energy consumption and trust evaluation was found using 200 nodes in a certain area. The nodes were clustered using FBPSO algorithm. The simulation was done in NS2 tool. Table II illustrates the simulation parameters for the network model.

Fig. 6 shows total number of route discovery, Fig. 7 shows packet delivery ratio versus number of paths, Fig. 8 shows delays obtained in the network, Fig. 9 shows routing overload versus number of paths, Fig. 10 shows load balancing and Fig. 11 shows energy consumption ratio. The simulation result shows that the presented algorithm worked well.

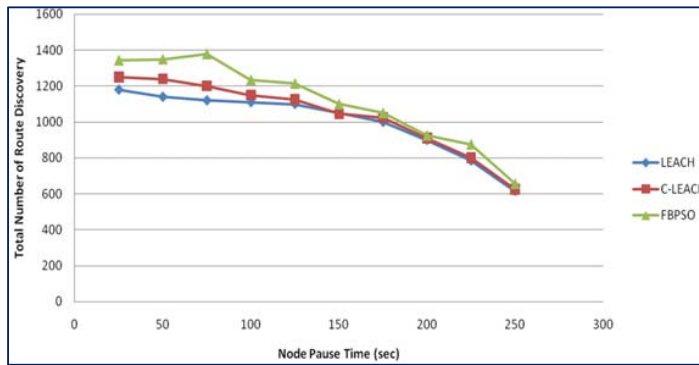

Fig. 6 Total Number of Route Discovery

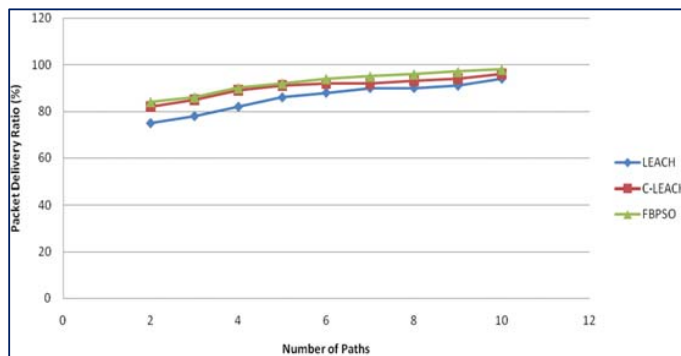

Fig. 7 Packet Delivery Ratio versus Number of Paths

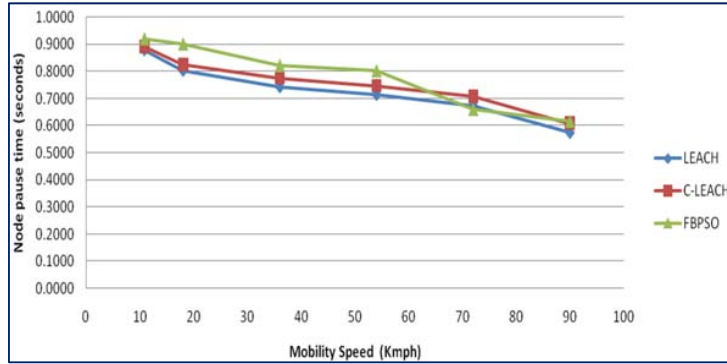

Fig. 8 Delays obtained in the Network

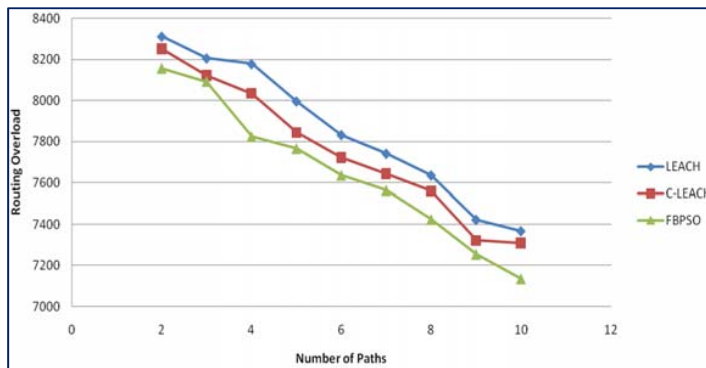

Fig. 9 Routing Overload versus Number of Paths

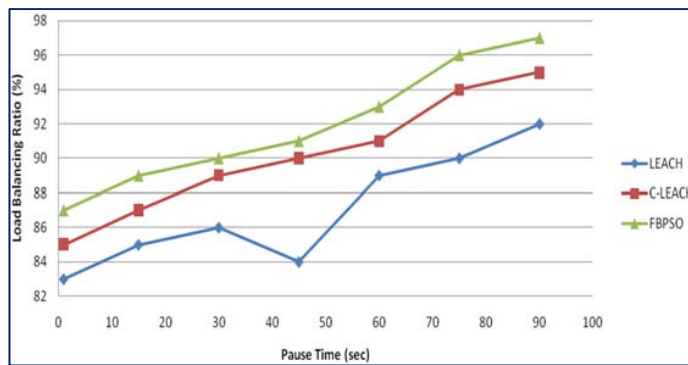

Fig. 10 Load Balancing

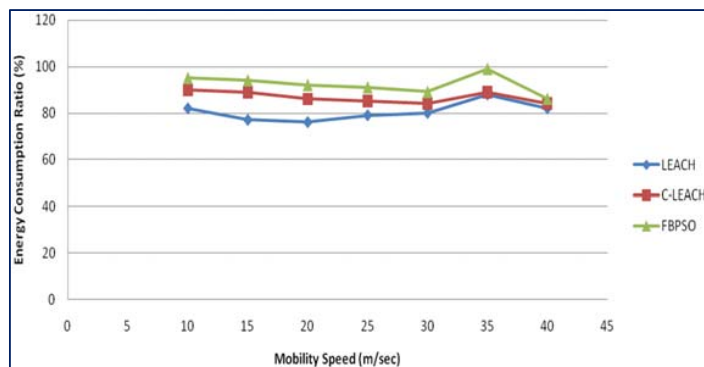

Fig. 11 Energy Consumption Ratio

IV. CONCLUSION

To increase the load balance and of the network in WSNs, this paper recommends an improved routing protocol Fuzzy Based Particle Swarm Optimization. FBPSO improves three important factors of distance, energy and density. Distance to the Base station as the input to compute the possibility of a node for CH and Radius. The fuzzy logic is used to decrease

the uncertainties of existing in WSNs. The fuzzy introduction and Multi-hop routing method for transmission of data can handle the load balancing and reduce the consumption of the energy frequently. Better performance of our recommended algorithm has been exhibited by the simulation results. FBPSO algorithm can efficiently load balancing in the network and network lifetime.

TABLE I
FUZZY INFERENCE RULE

S.NO	DISTANCE	DENSITY	ENERGY	PROBABILITYCHANCE	COMPETATIONRADIUS
1	Low	Spare	Far	Very Weak	Medium
2	Low	Spare	Medium	Weak	Little Small
3	Low	Spare	Near	Little Weak	Little Small
4	Low	Medium	Far	Weak	Little Small
5	Low	Medium	Medium	Little Weak	Little Small
6	Low	Medium	Near	Lower Medium	Small
7	Low	Dense	Far	Little Weak	Little Small
8	Low	Dense	Medium	Lower Medium	Small
9	Low	Dense	Near	Medium	Small
10	Medium	Spare	Far	Little Weak	Little Large
11	Medium	Spare	Medium	Lower Medium	Little Large
12	Medium	Spare	Near	Medium	Medium
13	Medium	Medium	Far	Lower Medium	Little Large
14	Medium	Medium	Medium	Medium	Medium
15	Medium	Medium	Near	Higher Medium	Medium
16	Medium	Dense	Far	Medium	Medium
17	Medium	Dense	Medium	Higher Medium	Little Small
18	Medium	Dense	Near	Little Strong	Little Small
19	High	Spare	Far	Medium	Large
20	High	Spare	Medium	Higher Medium	Large
21	High	Spare	Near	Little Strong	Little Large
22	High	Medium	Far	Higher Medium	Little Large
23	High	Medium	Medium	Little Strong	Little Large
24	High	Medium	Near	Strong	Medium
25	High	Dense	Far	Little Strong	Little Large
26	High	Dense	Medium	Strong	Medium
27	High	Dense	Near	Very Strong	Medium

TABLE II
SIMULATION PARAMETERS

Parameter	Value
Number of nodes	200
Size of the Network	225 m x 225 m
Energy in the beginning	0.50 J
Length of the Data packet	4000 bits
Length of the Control packet	100 bits
Sender Transmitter expand	1.1dBi
Receiver transmitter expand	1.1dBi

REFERENCES

- [1] Blaho, M., Urban, M., Fodrek, P., & Foltin, M. (2012). Wireless network effect on PI and type-2 fuzzy logic controller. *International Journal of Communications*, 6(1), 18–25.
- [2] Harold Robinson, Y., & Rajaram, M. (2015). "Trustworthy link failure recovery algorithm for highly dynamic mobile adhoc networks", *World Academy of Science, Engineering and Technology, International Journal of Electrical, Computer, Energetic, Electronic and Communication Engineering*, vol.9, no.2, 233–236.
- [3] Li, C., Ye, M., Chen, G., & Wu, J. (2005). An energy-efficient unequal clustering mechanism for wireless sensor networks. In *IEEE international conference on mobile adhoc and sensor systems conference (MAHSS)* (pp. 597–604).
- [4] Bagci, H., & Yazici, A. (2010). An energy aware fuzzy unequal clustering algorithm for wireless sensor networks. In *Proceeding of IEEE international conference on fuzzy systems (FUZZ)* (pp. 1–8).
- [5] Lindsey, S., & Raghavendra, C.S. (2002). PEGASIS: Power-efficient gathering using in sensor information systems. In *Proceeding of IEEE aerospace conference* (pp. 1125–1130). Big Sky: Montana.
- [6] Handy, M., Haase, M., & Timmermann, D. (2002). Low energy adaptive clustering hierarchy with deterministic cluster-head selection. In *The 4th international workshop on mobile and wireless communications network* (pp. 368–372).
- [7] Wang, L. X. (1996). *A course in fuzzy systems and control*. Englewood Cliffs: Prentice-Hall Inc.
- [8] Harold Robinson, Y., & Rajaram, M. (2016), "A memory aided broadcast mechanism with fuzzy classification on a device-to-device mobile Ad Hoc network", *Wireless Personal Communications*, 1–23, doi:10.1007/s11277-016-3213-0.
- [9] Colorni, A., Dorigo, M. & Maniezzo, V. (1991). Distributed optimization by ant colonies. In *Proceedings of ECAL91-European conference on artificial life* (pp. 134–142). Paris, France: Elsevier.
- [10] Zhang, F., Zhang, Q. Y., & Sun, Z. M. (2013). ICT2TSK: An improved clustering algorithm for WSN using a type-2 Takagi–Sugeno–Kang fuzzy logic system. In *2013 IEEE symposium on wireless technology and applications (ISWTA)*, September 22–25 (pp. 153–158). Malaysia: Kuching.
- [11] Harold Robinson, Y., & Rajaram, M. (2015), "Energy-aware multipath routing scheme based on particle swarm optimization in mobile ad hoc networks", *The Scientific World Journal*, 1–9. doi:10.1155/2015/284276.
- [12] Harold Robinson, Y., & Rajaram, M. (2015), "Establishing pairwise keys using key Predistribution schemes for sensor networks", *World Academy of Science, Engineering and Technology International Journal of Computer, Electrical, Automation, Control and Information Engineering*, 9(2), 608–612.

- [13] Ayyasamy, A., and K. Venkatachalapathy. "Context aware adaptive fuzzy based QoS routing scheme for streaming services over MANETs." *Wireless Networks* 21.2 (2015): 421-430.
- [14] Ayyasamy, A., and K. Venkatachalapathy. "Increased Throughput for Load based Channel Aware Routing in MANETs with Reusable Paths." *International Journal of Computer Applications* 40.2 (2012): 20-23.
- [15] Balaji, S., Harold Robinson, Y. and Rajaram, M. (2016) SCSBE: Secured Cluster and Sleep Based Energy-Efficient Sensory Data Collection with Mobile Sinks. *Circuits and Systems*, 7, 1992-2001. <http://dx.doi.org/10.4236/cs.2016.78173>
- [16] Estrin, D., Govindan, R., Heidemann, J. and Kumar, S. (1999) Next Century Challenges: Scalable Coordination in Sensor Networks. *Proceedings of the 5th Annual ACM/IEEE International Conference on Mobile Computing and Networking*, 263-270.
- [17] Kang, S.H. and Nguyen, T. (2012) Distance Based Thresholds for Cluster Head Selection in Wireless Sensor Networks. *IEEE Communications Letters*, 16, 1396-1399.
- [18] Robinson, Y.H., Balaji, S. and Rajaram, M. (2016) ECBK: Enhanced Cluster Based Key Management Scheme for Achieving Quality of Service. *Circuits and Systems*, 7, 2014-2024. <http://dx.doi.org/10.4236/cs.2016.78175>.
- [19] Rijin, I.K., Sakthivel, N.K. and Subasree, S. (2013) Development of an Enhanced Efficient Secured Multi-Hop Routing Technique for Wireless Sensor Networks. *International Journal of Innovative Research in Computer and Communication Engineering*, 1, 506-512.
- [20] Neto, A. (2013) A Cluster-Based Approach to Provide Energy-Efficient in WSN. *International Journal of Computer Science and Network Security*, 13, 55-62.
- [21] Harold Robinson, Y., Rajaram, M., Golden Julie, E. and Balaji, S. (2016) Dominating Set Algorithm and Trust Evaluation Scheme for Secured Cluster Formation and Data Transferring. *World Academy of Science, Engineering and Technology, International Journal of Computer, Electrical, Automation, Control and Information Engineering*, Vol. 10, No. 2, pp. 388-393.
- [22] Hwang, D., & Kim, D. (2008). DFR: Directional flooding-based routing protocol for underwater sensor networks. In *OCEANS 2008*. IEEE
- [23] Yan, H., Shi, Z. J., & Cui, J. H. (2008). DBR: depth-based routing for underwater sensor networks. In *International conference on research in networking* (pp. 72–86). Springer Berlin Heidelberg.
- [24] Harold Robinson, Y., Rajaram, M., Golden Julie, E. and Balaji, S. (2016), "Tree Based Data Fusion Clustering Routing Algorithm for Illimitable Network Administration in Wireless Sensor Network", *World Academy of Science, Engineering and Technology, International Journal of Computer, Electrical, Automation, Control and Information Engineering* Vol:10, No:6, pp. 1123 – 1130.
- [25] Yang, X.-S., & He, X. (2013). Bat algorithm: Literature review and applications. *International Journal of Bio-Inspired Computation*, 5(3), 141–149.
- [26] Lee, U., et al. (2010). Pressure Routing for underwater sensor networks. In *INFOCOM*.
- [27] Harold Robinson, Y., Rajaram, M., Golden Julie, E. and Balaji, S. (2016), "TBOR: Tree Based Opportunistic Routing for Mobile Ad Hoc Networks", *World Academy of Science, Engineering and Technology, International Journal of Computer, Electrical, Automation, Control and Information Engineering* Vol:10, No:6, pp. 1115 – 1122.
- [28] Moradpoor, N., Parr, G., McClean, S., Scotney, B., & Owusu, G. (BT Laboratories). Interleaved polling with adaptive cycle time (IPACT) Implementations using OPNET MODELER. *India-UK Advanced Technology Centre of excellence in next generation networks, systems and services*.
- [29] Singh, S., & Agrawal, S. (2014). VANET routing protocols: Issues and challenges. In *2014 Recent Advances, Engineering and Computational Sciences (RAECS)* (pp. 1–5). IEEE
- [30] Ramalakshmi, S., & Robinson, Y. H. (2014). "ATMPH: Attaining optimal throughput capacity of MANET with power control in heterogeneous network", *Programmable Device Circuits and Systems*, 6(4), 111–115.
- [31] Rappaport, T. S. (1996). *Wireless communications: Principles and practice* (Vol. 2). New Jersey: Prentice Hall PTR.
- [32] Yang, L., & Yang, H-C. (2005). Cooperator switch diversity in cooperative networks. In *2005 IEEE Pacific rim conference on communications, computers and signal processing*, 2005. PACRIM, pp. 308–311, IEEE.
- [33] Robinson, Y. H., & Rajeswari, S. R. (2011). "Energy-based dynamic encryption for wireless sensor networks. *Wireless Communication*", vol.3, no.9, pp. 661–663.
- [34] Miller, A., & Speidel, J. (2010). Switch-and-stay transmit diversity for cooperative decode-and-forward systems. In *Wireless communications and networking conference (WCNC)*, pp. 1–6.
- [35] Selvaraj, M. D., & Mallik, R. K. (2009). Error analysis of the decode and forward protocol with selection combining. *IEEE Transactions on Wireless Communications*, 8(6), 3086–3094.
- [36] Harold Robinson, Y., & Rajaram, M. (2014). "A novel approach to allocate channels dynamically in wireless mesh networks", *World Academy of Science, Engineering and Technology, International Journal of Computer, Electrical, Automation, Control and Information Engineering*, vol. 8, no.10, pp. 1865–1868.
- [37] Selvaraj, M. D., & Mallik, R. K. (2012). Performance of full CSI selection combining for cooperative diversity systems'. *IEEE Transactions on Communications*, 60(9), 2482–2488.
- [38] Ko, Y.-C., Alouini, M.-S., & Simon, M. K. (2000). Average SNR of dual selection combining over correlated Nakagami-m fading channels. *IEEE Communications Letters*, 4(1), 12–14.
- [39] Golden Julie, E., Tamil Selvi, S., & Harold Robinson, Y. (2014). "Opportunistic routing with secure coded wireless multicast using MAS approach", *World Academy of Science, Engineering and Technology, International Journal of Computer, Electrical, Automation, Control and Information Engineering*, vol. 8, no.7, pp. 1247–1250.
- [40] Li, G., et al. (2012). Performance analysis of incremental relaying for amplify-and-forward cooperative networks in Nakagami-m channels. In *2012 2nd international conference on computer science and network technology (ICCSNT)*, IEEE, pp. 1681–1685.
- [41] Kim, Y., & Beaulieu, N. (2015). SEP of decode-and-forward cooperative systems with relay selection in Nakagami-m fading channels. *IEEE Transactions on Vehicular Technology*, 64(5), 1882–1883.
- [42] Golden Julie, E., Tamil Selvi, S., & Harold Robinson, Y. (2016). "Performance Analysis of Energy Efficient Virtual Back Bone Path Based Cluster Routing Protocol for WSN", *Wireless Personal Communications*, Springer, 1–19, DOI 10.1007/s11277-016-3520-5.
- [43] Swaminathan, R., Roy, R., & Selvaraj, M. (2015). Performance comparison of selection combining with full CSI and switch-and-examine combining with and without post-selection. *IEEE Transactions on Vehicular Technology*, 65(5), 3217–3230.
- [44] Yick, J., Mukherjee, B., & Ghosal, D. (2008). *Wireless sensor network survey*. *Computer networks*, 52(12), 2292–2330.
- [45] Harold Robinson, Y., Rajaram, M., Golden Julie, E. and Balaji, S. (2016), "Detection of Black Holes in MANET Using Collaborative Watchdog with Fuzzy Logic", *World Academy of Science, Engineering and Technology, International Journal of Computer, Electrical, Automation, Control and Information Engineering* Vol:10, No:3, pp. 575 – 581.
- [46] Stankovic, J. A., Wood, A. D., & He, T. (2011). Realistic applications for wireless sensor networks. In S. Nikolettseas & J. D. P. Rolim (Eds.), *Theoretical aspects of distributed computing in sensor networks* (pp. 835–863). Berlin: Springer.
- [47] Momani, M., & Challa, S. (2010). Survey of trust models in different network domains. *arXiv preprint arXiv:1010.0168*.
- [48] Golden Julie, E., & Tamil Selvi, S. (2016). Development of energy efficient clustering protocol in wireless sensor network using neuro-fuzzy approach. *The Scientific World Journal* 2016, Article ID 5063261, 1–8.
- [49] Sakthidevi, I., & Srievidhyajanani, E. (2013). Secured fuzzy based routing framework for dynamic wireless sensor networks. In *International conference on circuits, power and computing technologies (ICCPCT)* (pp. 1041–1046). IEEE.
- [50] Xia, H., Jia, Z., & Sha, E. H. M. (2014). Research of trust model based on fuzzy theory in mobile ad hoc networks. *IET Information Security*, 8(2), 88–103.
- [51] E. Golden Julie, E. Sahaya Rose Vigita, S. Tamil Selvi (2014), "Distributed Self-Healing Protocol for Unattended Wireless Sensor Network", *World Academy of Science, Engineering and Technology, International Journal of Computer, Information, Systems and Control Engineering* Vol:8 No:10, pp. 1680 – 1683.
- [52] Xia, H., Jia, Z., Ju, L., Li, X., & Zhu, Y. (2011). A subjective trust management model with multiple decision factors for MANET based on AHP and fuzzy logic rules. In *2011 IEEE/ACM international conference*

on green computing and communications (GreenCom) (pp. 124–130). IEEE.

- [53] Yu, L., Liu, Z., Gao, Y., & Samba, D. (2012). Trust evaluation model based on behavior space classification for ad hoc networks. *Tsinghua Science and Technology*, 17(2), 179–185.
- [54] S. Balaji, M. Rajaram (2014), "EUDIS-An Encryption Scheme for User-Data Security in Public Networks", *World Academy of Science, Engineering and Technology, International Journal of Computer, Information, Systems and Control Engineering* Vol:8 No:11, pp. 1825 – 1830.
- [55] Luo, J., Liu, X., Zhang, Y., Ye, D., & Xu, Z. (2008). Fuzzy trust recommendation based on collaborative filtering for mobile ad-hoc networks. In *33rd IEEE conference on local computer networks (LCN)* (pp. 305–311). Montreal.
- [56] Xia, H., Jia, Z., Ju, L., & Zhu, Y. (2011). Trust management model for mobile ad hoc network based on analytic hierarchy process and fuzzy theory. *IET Wireless Sensor Systems*, 1(4), 248–266.
- [57] G. Arun SamPaul Thomas, R.Karthik Ganesh, A.Kandasamy, S.Balaji, Y. Harold Robinson, (2011) "An Advanced Controlled-Flooding Routing with Group Organization for Delay Tolerant Networks using A-SMART", *Emerging Trends in Electrical and Computer Technology (ICETECT)*, 978-1-4244-7926-9/11, IEEE.
- [58] Li, X., Jia, Z., Zhang, P., & Wang, H. (2010). A trust-based multipath routing framework for Mobile Ad hoc NETWORKS. In *2010 Seventh international conference on fuzzy systems and knowledge discovery (FSKD)* (Vol. 2, pp. 773–777). IEEE.
- [59] Liao, X. F. (2011). Research on subject trust evaluation based on fuzzy theory. In *Advanced engineering forum* (Vol. 1, pp. 52–56). Trans Tech Publications.
- [60] S. Balaji, M. Rajaram (2016), "SIPTAN: Securing Inimitable and Plundering Track for Ad Hoc Network", *Wireless Personal Communications*, Springer, 1-21, DOI 10.1007/s11277-016-3187-y.
- [61] Abouelfadl, A. A., El-Bendary, M. A. M., & Shawki, F. (2014). Enhancing transmission over wireless image sensor networks based on ZigBee network. *Life Science Journal*, 11(8), 342–354.
- [62] El-Bendary M. A. M., Kasban, H., & El-Tokhy, M. A. R. (2014). Interleaved reed-solomon codes with code rate switching over wireless communications channels. In: *International Journal of Information Technology and Computer Science (IJITCS)* (<http://www.ijitcs.com>) on, 16(1).
- [63] Harold Robinson, Y. Golden Julie E, Balaji S, Ayyasamy A, (2016), *Energy Aware Clustering Scheme in Wireless Sensor Network Using Neuro-Fuzzy Approach*, *Wireless Personal Communications*, Springer, 1-19, Doi: 10.1007/s11277-016-3793-8
- [64] Y. Xu, A. Saifullah, Y. Chen, C. Lu, S. Bhattacharya, Near optimal multiapplication allocation in shared sensor networks, in: *Proceedings of the Eleventh ACM International Symposium on Mobile Ad Hoc Networking and Computing, MobiHoc '10*, ACM, New York, NY, USA, 2010, pp. 181–190. doi:10.1145/1860093.1860118. URL <http://doi.acm.org/10.1145/1860093.1860118>.
- [65] R. Huang, X. Chu, J. Zhang, Y. H. Hu, Energy-efficient monitoring in software defined wireless sensor networks using reinforcement learning: A prototype, *International Journal of Distributed Sensor Networks* 2015. doi:10.1155/2015/360428.
- [66] S Balaji, M Rajaram, Y Harold Robinson, E Golden Julie (2016), 'A Hypercube Social Feature Extraction and Multipath Routing in Delay Tolerant Networks', *International Journal of Computer, Electrical, Automation, Control and Information Engineering, World Academy of Science, Engineering and Technology*, Vol. 10, No. 6, pp. 1212 – 1221.



Mrs. E. Golden Julie received her B.E degree in Computer Science and Engineering in 2005 from Anna University Chennai and ME degree in Computer Science and Engineering in 2008 from Anna University Chennai. Currently she is Pursuing her Ph.D from Anna University Chennai. Presently she is working as assistant professor in Regional centre Anna University, Tirunelveli, India She has published many research papers in various fields. Her research area includes Wireless Sensor Adhoc Networks and Image Processing. She is a member of ISTE.



Prof. Dr. M. Rajaram M.E., Ph.D. is the Vice-Chancellor of Anna University, Chennai. As a research guide, Dr. M. Rajaram produced 30 Ph.D.'s and four M.S. scholars in various fields. At present, 10 research scholars are pursuing their Ph.D. under his direct supervision. He has contributed to the areas of Computer Networks, High Voltage Engineering, Measurement and Instrumentation, Adaptive Controller, Electro-Magnetic Theory, and Intelligent Computing with his 157 publications in renowned research journals, 111 research publications in International Conferences, 73 research publications in National Conferences, more than 100 technical reports and six technical books some of which he has co-authored.



Dr. Y. Harold Robinson, M.E., Ph.D., is currently working as an Associate Professor, Dept of CSE in SCAD College of engineering and Technology, Tirunelveli. He completed Ph.D. in Anna University Chennai. He finished ME degree in Anna University, Chennai. His research interests are Wireless Networks Mobile Computing, Wireless Sensor Networks. He has published several Research papers in International Journals. He has presented many papers in National and International conferences in Network security, Mobile Computing and Cloud Computing.



Dr. S. Balaji, M.E, MISTE., Ph.D., completed Ph.D in Anna University, Chennai and currently working as an Associate Professor in Dept of CSE at Francis Xavier Engineering College, Tirunelveli. His research interests are Wireless Networks Mobile Computing, Network Security with apps, Wireless Sensor Networks, Cloud Computing. He has presented many papers in National and International conferences in network security, Mobile Computing, network security, and Cloud Computing. He has organized and conducted various national and international conferences, International Seminars and National Workshops. And also his methodology of teaching about TCP & UDP is hosted on Wipro Mission 10x portal. He is a life time member of ISTE.