

# Gas Lift Optimization Using Smart Gas Lift Valve

Mohamed A. G. H. Abdalsadig, Amir Nourian, G. G. Nasr, M. Babaie

**Abstract**—Gas lift is one of the most common forms of artificial lift, particularly for offshore wells because of its relative down hole simplicity, flexibility, reliability, and ability to operate over a large range of rates and occupy very little space at the well head. Presently, petroleum industry is investing in exploration and development fields in offshore locations where oil and gas wells are being drilled thousands of feet below the ocean in high pressure and temperature conditions. Therefore, gas-lifted oil wells are capable of failure through gas lift valves which are considered as the heart of the gas lift system for controlling the amount of the gas inside the tubing string. The gas injection rate through gas lift valve must be controlled to be sufficient to obtain and maintain critical flow, also, gas lift valves must be designed not only to allow gas passage through it and prevent oil passage, but also for gas injection into wells to be started and stopped when needed. In this paper, smart gas lift valve has been used to investigate the effect of the valve port size, depth of injection and vertical lift performance on well productivity; all these aspects have been investigated using PROSPER simulator program coupled with experimental data. The results show that by using smart gas lift valve, the gas injection rate can be controlled which leads to improved flow performance.

**Keywords**—Effect of gas lift valve port size, effect water cut, and vertical flow performance.

## I. INTRODUCTION AND LITERATURE REVIEW

RESERVOIR pressure declines with time and consequently, production rate decreases. Gas lift is used to increase oil production rates and to enable non flowing wells to flow by reducing the density of the fluid column in the well. Gas lift systems can also mitigate the effects of high water cut and help to maintain tubing head pressure in subsea wells [1]

The concept of gas lift system is injection of high pressure gas from the surface through the annular to the tubing. This may be done by continuously supplementing the reservoir energy by injecting relatively small volumes of high pressure gas (continuous flow), or by the injection in a short period of time of a relatively large volume of gas underneath an accumulated slug of liquid in order to move the slug intact to the surface (intermittent lift) [2].

The optimum design of gas lift system is dependent upon the critical combination of a quantity of pertinent variables, including gas lift valve performance, reservoir pressure, water cut, productivity index, gas oil ratio, tubing size and injection gas pressure. The economic performance of the optimum design is dependent upon maintaining a minimum injection gas rate which led to improve oil production rate [3].

The determination of gas passage through a certain valve is the most important factor of gas lift string design. The main

criteria for an unloading valve is that it will permit sufficient gas to unload the well to the extent that the next (lower) valve can be uncovered, and that it will close and remain closed once lift gas is injecting deeper in the tubing string [4]

There are many types of gas lift valves available on the market. Some are designed for use in continuous gas lift, some for intermittent lift. Both types are manufactured for either tubing flow or annular flow. The closing force in some valves is generated by nitrogen pressure enclosed in a chamber within the valve. In others, a spring provides the closing force. A third type uses a combination of spring and nitrogen charge to provide the closing force. [4]

In a traditional gas lift system, the tubing is fitted with a side pocket mandrel, where the side pocket can have a gas lift valve; the gas-lift valve can be pre-installed or placed in the side pocket by means of wire line. [5] These technologies have design limitations on gas lift valve such as, multi-point of injection, nitrogen charge also, pressure operated valve is very sensitive to well performance condition such as pressure, temperature and casing pressure [5], [6].

An efficient gas lift technique is directly related to an increased production rate. Therefore, the proper selection of a gas lift valve is of significant importance in the recovery process. In this paper, gas lift valve port sizes and their effect on the well production performance has been carried out by using smart gas lift valve.

Yadav et al. reviewed several typical smart well systems and defined the smart completion as a system capable of collecting, transmitting and analyzing well bore production, reservoir and completion integrity data, then enabling remote action to enhance reservoir control and well performance [7].

Laing [8] studied extensively an overview of gas lift valve performance analysis and shows that significant improvement of production can be achieved by solving gas lift performance problems.

Stewart et al. decreased orifice sizes of the gas lift valves and redesigned the gas lift headers to remove the problems of slugging and hydrate formation. Capucci et al. developed a true transient unloading model [9]. Bertovic et al. described theoretical analysis supported by experiments to determine a practical model for gas lift valve performance [10]. Yula et al. presented a new transient model and dynamic simulator that describe the complicated characteristics of the gas lift unloading process [11]. Faustinelli et al. studied a new unified model that predicts the flow performance of nitrogen charged injection pressure operated gas lift valves [12]. Shahri applied method for measurement of injection gas throughput of gas lift valve before the well installation [13].

Elldakli et al. studied theoretical design which indicated that the stem travel from the modified design was improved from 5 to 58% compared to using conventional sharp-edged

Mohamed A. G. H. Abdalsadig is with the School of Engineering, University of Salford, United Kingdom (e-mail: M.A.Abdalsadig@edu.salford.ac.uk).

seat and the results shows that gas lift valve does not open fully in actual operated [14].

Gas-lift valves do not pop open, and thus, the static force balance equations that are used to calculate opening and closing pressures are not appropriate for calculating flow performance [15].

Proper function of gas lift valves is very important for the safety of the well and surface operations. If hydrocarbons flow through the incorrect path (i.e. backflow from the tubing into the annulus, through a gas lift valve leakage), they can reach the wellhead and create an undesired accumulation of high-pressure combustible material. Incorrect manipulation of surface valves, procedures and accumulation of gasses is thought to have caused the 1988 accident on the Piper Alpha North Sea production platform, which led to an explosion and fire killing 167 men [16].

From an extensive literature review that has been carried out which indicated that the gas lift valve often does not open fully in actual operation. Consequently, actual flow through the gas lift valve is considerably less than what would be predicted using full-open models. Also, the gas-lift system designer must be able to predict how far each valve will open under each condition of upstream and downstream pressure, and how much gas it will transmit under each condition.

## II. THE AIM AND OBJECTIVES

In this paper, smart gas lift valve was used to allow the port size of the gas lift valve to be remotely adjusted from the surface by a computer program which controls the gas passage through the valve. Furthermore, obtaining the optimum gas injection rate is important as a result of excessive gas injection decline production rate and consequently increases the operation cost.

The aim of the study is to analyse the effect of different valve port sizes on the well production performance by using experimental data and PIPSIM and PROSPER Softwares [17] [18].

This analysis will lead to investigate the following objectives:

- i. Identify the Pressure and temperature surveys
- ii. Study the vertical lift performance and water cut effect.
- iii. Identify how smart gas lift valve improve liquid flow rate from natural flow and gas lift wells.

## III. METHODOLOGY

Experiment Description: In order to facilitate the emulation of a real-world well, the following main components are presented. Realistic test for gas lift wells are preformed using gas lift well laboratory facilities. It is shown in Fig. 1.

Experimental equipment:

1. Plastic storage tank
2. Centrifugal pump
3. Hand valve
4. By pass line
5. Inflow digital
6. Check valve

7. Transparent tubing
8. Gas lift valve
9. Pressure Gauge
10. Outflow digital
11. Flow line
12. Gas compressor
13. Gas flow meter
14. Gas regulator
15. Gas lift line
16. Control line
17. Monitor system

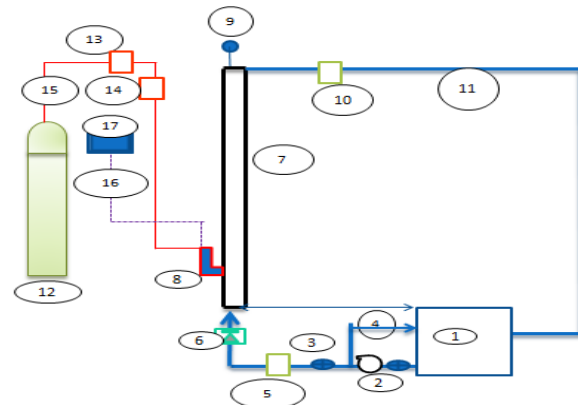

Fig. 1 The Experiment Flow Diagram

The production tube is PVC transparent to facilitate visual inspection of the flow regimes and changes at different locations. The length of the tube is 2 meters with an inner diameter of 66 mm; and outer diameter 76 mm. A pump is used to deliver high pressure water from plastic tank to the certain level into the transparent tube. The pump can be operated with a variable speed to produce proper pressure (referred to the reservoir pressure) and also can be controlled by using a manual valve at the discharge of the pump. When the pump pressure is not able to deliver the fluid to the surface, gas lift technique will be applied by injecting air into the tubing. Electric valve is used to inject air into the tubing. The valve is connected to control line to provide real opening or closing and can be operated with variable opening flow rate by the use of computer program. Air flow that fed into the tubing can be controlled at different flow rates and different injection pressures by using air injection regulator and air flow meter. As soon as the air is injected into the tubing, the fluid hydrostatic pressure and the density of the production fluid reduces and the fluid will be delivered out of the tubing. Inflow and outflow are measured by two digital flow meters and pressure gauges are also installed to monitor the inlet and out let pressure.

## IV. WELL MODEL CONSTRUCTION

The system has been modelled by using PIPSIM and PROSPER Softwares [17], [18]. Experimental results data were entered to the model. Input data including the deviation

survey, down hole completion, geothermal gradient, and the gas lift data were entered for the assumed wells.

V. RESULTS

A. Pressure Surveys

Subsurface static and flowing pressure surveys the best and most widely used method of properly analysing gas lift installation. Static bottom hole pressure will determine static fluid level, static gradient pressure gradient surveys have been performed by making station stops at various depths along the completion. A flowing pressure and temperature survey, on the other hand, will locate the point of gas injection, leak in the tubing, valve failures and multi-point injection. A flowing pressure survey will also determine the flowing gradient above and below the point of injection. Fig. 2 shows the experiment flow pressure surveys from the reservoir storage tank to the surface. The result in Table I shows the experiment results as compared with software results.

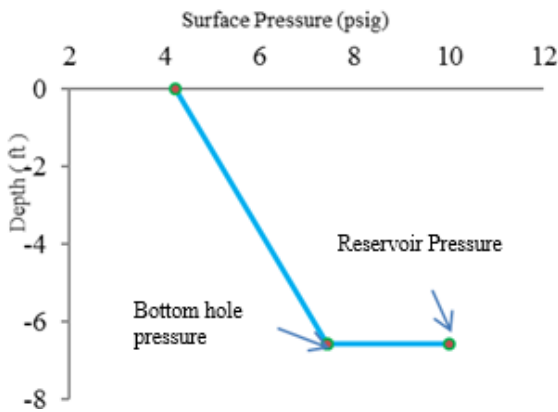

Fig. 2 Experiment Software Flowing Pressure Surveys

TABLE I  
THE SUBSURFACE STATIC AND FLOWING PRESSURE SURVEYS AND PRODUCTION LIQUID RATE VALIDATED WITH SOFTWARE

	Software	Experiment
Production rate average bbl./day	138	130
Outlet well head pressure psig	4	4
Reservoir pressure psig	10	10
Flowing bottom hole pressure psig	7.4	7
Flowing well head temperature °F	75	75

B. Predicting Accurate Temperature Pressure Profiles

Predicting accurate temperature and pressure profiles in flowing well scan greatly improves the design of production facilities in petroleum engineering. Temperature profiles help to calculate accurate two-phase-flow pressure-drop predictions, which in turn can improve an artificial-lift system design. Gas-lift design can be enhanced by more accurate prediction of temperature at valve depth. Fig. 3 shows the experimental gradient traverse that illustrated the pressure profile and flow regime types from bottom of the tubing to manifold. Table II clearly shows that the gas flow gradient 0.25 and water gradient is 0.449.

TABLE II  
PRESSURE PROFILE AND FLOW REGIME FOR THE EXPERIMENT

Bottom Measured Depth feet	Pressure psig	Gradient Psi/ft.	Flow Regime Types / location
0	1.50	0	Manifold
0	1.52	0.25	Choke
0	3.5	0.25	Well head
3.1	3.8	0.4491	Bubble
6.2	4.32	0.44918	Bubble
6.4	4.40	0.4491	Bubble
6.6	4.48	0.4419	Bubble

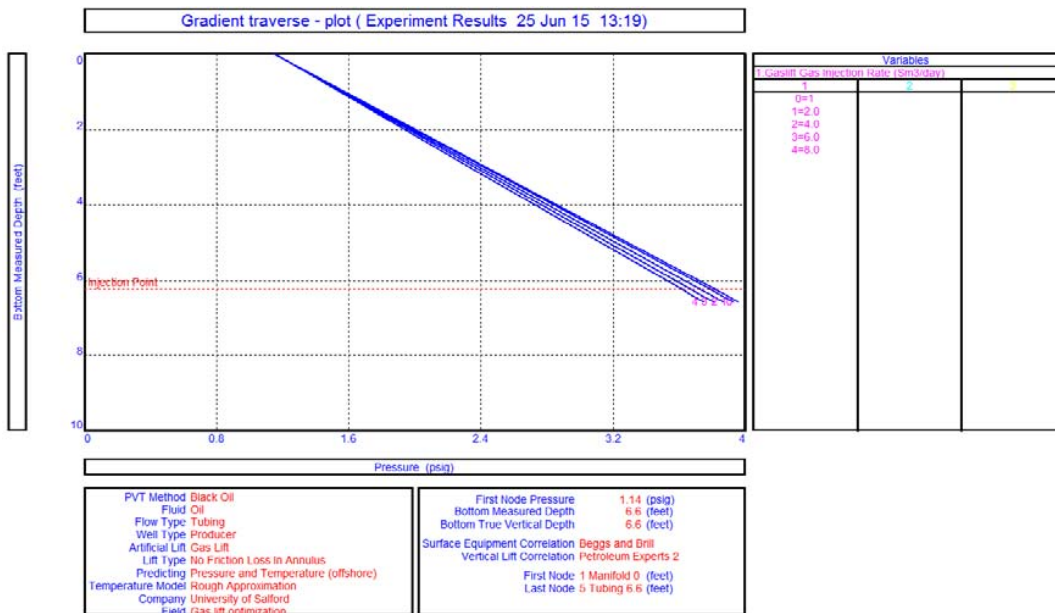

Fig. 3 The Experimental Gradient Traverse

**C. Effect of Water Cut**

One of the most important production issues in oil fields is high water production which may lead to wells killing and reduction in an economical production period. With the increment of water production or decrease of reservoir pressure, reservoir drawdown pressure reduces which causes reduction in oil production rate; however, the percentage of water cut produced should be controlled.

Experiment was carried out to investigate the effect of water cut in the well performance. The results indicated that increasing water cut will lead to an increase in the interfacial tension which resulted to decrease in liquid flow rate. Table III shows that increase water cut from 10 to 100% leads to

decrease bottom hole pressure from 7.55 psi to 4 psi. However, increasing water cuts results to an increase in liquid density, which in turn, increases hydrostatic forces and the bottom hole pressure as seen in Table III and Fig. 4.

TABLE III  
THE EFFECT OF WATER CUT

Water cut %	Oil rate stb/d	Water rate stb/d	Bottom hole pressure psi	Wellhead Interfacial Tension dyne/cm
10	45.7	5.1	7.55	27.4757
50	33	33	6.88	28.3242
100	0	132	4	71.8678

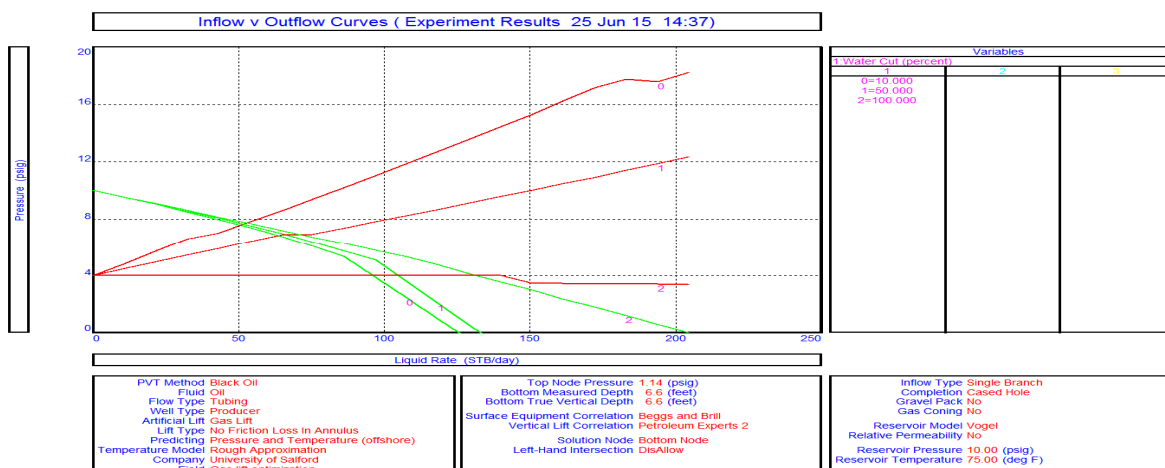

Fig. 4 The Effect of Water Cut

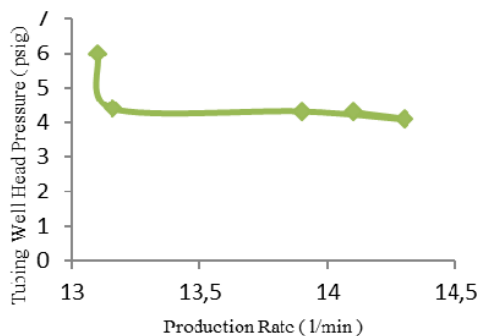

Fig 5 The Tubing Pressure Performance

**D. Vertical Lift Performance**

Oil wells normally produce a mixture of liquid and gas to the surface while phase conditions usually change along the path. At higher pressures, especially at the well bottom, flow may be single phase.

When the pressure decreases, there is subsequent release of the gases from the liquid flowing which is a major characteristic of multiphase flow. Therefore, the bottom hole pressure depends on the inflow and outflow performance and other factors such as liquid rate, fluid type, gas to liquid ratio, water cut, fluid properties and tubing size.

Fig. 5 illustrates the relationship between the tubing pressure and liquid production rate by using air injection lift. As soon as the air enters the tubing the pressure in the tubing falls from 6 psig to 4.1 psig and then remains constant and more increase of injection gas lift rate leads to increase tubing pressure which resulting in decline liquid flow rate decline can be achieved. Also, the results indicated that by using smart gas lift valve, tubing well head pressure can be controlled and optimum vertical flow pressure to get optimum production rate.

**E. The Effects of the Valve Port Size on Well Production**

Gas lift valve has been opened with different percentages to investigate the effect of the valve port size on liquid production. The results are presented in Fig. 6 as can be seen increasing the valve opening leads to decrease in liquid flow rate at both injection pressure. The optimum opening is at 50% for both injection pressure rates. Result analysis indicated that a larger orifice is increasingly unstable, whilst a smaller orifice provides a more stable performance.

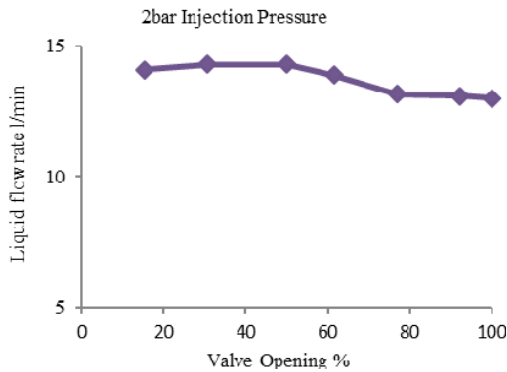

Fig. 6 The Effect of Valve Opening

#### F. Optimization of Tubing Size of Flowing Well

The fluid flow in tubing during flowing production can be analysed in accordance with the aforementioned vertical flow rule in tubing. The most sensitive factors affecting the pressure gradient distribution of multiphase vertical flow in tubing include tubing size, production rate, gas-liquid ratio, viscosity, and water cut. For a well design, the gas-liquid ratio, viscosity, and water cut are basically in a range, whereas the production rate can be controlled and changed.

In accordance with the theory of multiphase flow in tubing, each production rate value corresponds to the optimum tubing size so that the pressure gradient in tubing can be the minimum.

For a given production rate, an undersized tubing may have an excessive flow velocity so that the friction resistance maybe increased, whereas an oversized tubing may have a flow velocity on the low side so that a serious gas slippage effect may be caused. Also, the friction resistance and liquid phase loss due to slippage effect is at the optimum state when the appropriate tubing size is selected. Furthermore, selecting appropriate tubing size maximum energy utilization efficiency can be achieved which leads to improve in production rate.

In this study, different tubing sizes (1, 1.5, 2, 2.5 and 3) have been investigated and the results as shown in Fig. 6 indicated that increasing the tubing size will lead to an increase in the production rate. However, when the tubing size exceeds the critical tubing size, the increase in tubing size leads to insufficient improvement in production rate. From Fig. 6, it is clearly remarkable that increasing the tubing size from 2.5 psi to 3, inch provides slight enhancement in flow rate.

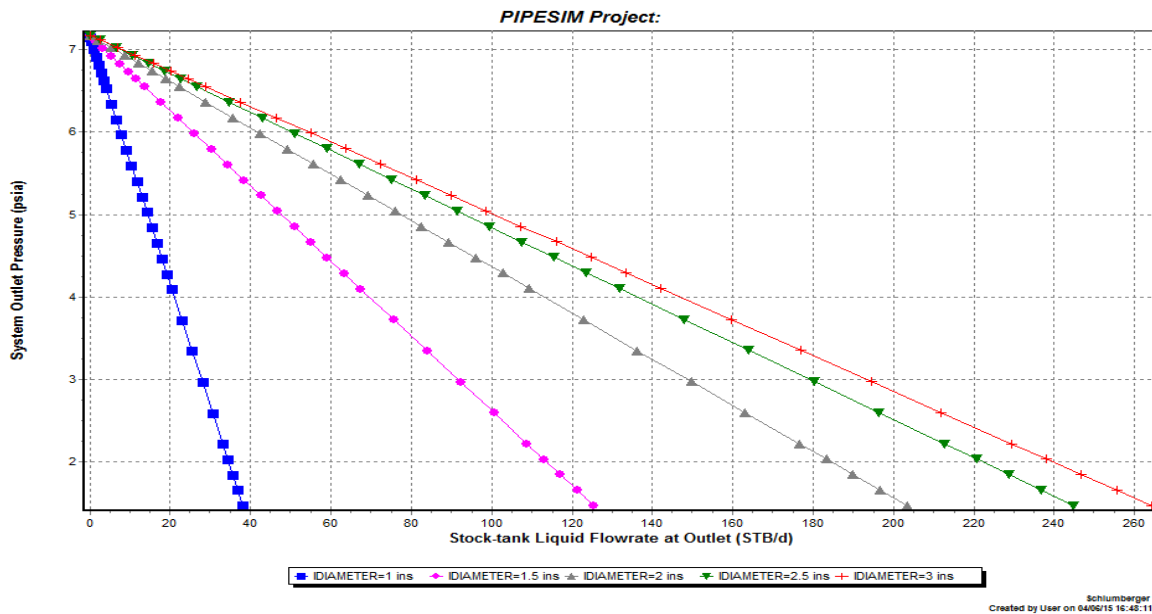

Fig. 7 Tubing Size Effect for Flowing Well

#### VI. CONCLUSION

1. This paper shows how smart gas lift valve can improve the performance of gas lifted wells by stabilizing the well flow and can be used for a long period of time over the life of the well.
2. Smart gas lift valve can be used to avoid gas lift wells instability under low lift gas injection, thus making it feasible to reduce the gas injection rate below the point where instability usually occur.

3. The effect of the valve port size on production performance has been studied and the results indicated that adjusted the gas lift port size from the surface leads to optimize well performance.
4. Smart gas lift valve technology eliminates multiple slickline trips or well intervention, reduces service costs.

#### REFERENCES

- [1] M. B. Mohamed A. G. H. Abdalsadig, Amir Nourian, G. G. Nasr, "Journal of Mechanical, Aerospace, Industrial, Mechatronic and

- Manufacturing Engineering Vol: 10, No:3, 2016.,” pp. 1–10, 2016.
- [2] J. L. Ortiz and S. A. Lagoven, “Gas-Lift Troubleshooting Engineering: An Improved Approach,” 1990.
- [3] R. W. Pittman, “Gas Lift Design and Technology,” *SPE,9981, Pet. Exhib. Tech. Symp. Soc. Pet. Eng. held Beijing, China, 18-26 March, 1982*.
- [4] G. Forero, K. McFadyen, R. Turner, B. Waring, and E. Steenken, “Artificial Lift Manual Part 2A,” Hague, 1993.
- [5] Z. Xu, B. M. Richard, J. H. Kritzler, and B. Hughes, “Smart Gas Lift Valves Enhance Operational Efficiency of Offshore Wells,” *SPE 166291*, no. October, 2013.
- [6] Weatherford Company Mnuual, “Gas-Lift Troubleshooting,” 2007.
- [7] V. Yadav and N. Surya, “Evaluating the Performance of Intelligent Completions,” *SPE 150408*, no. March, pp. 27–29, 2012.
- [8] D. J. Stewart, J. Goodacre, and C. Cruicksank, “Bass Strait: Production Decline Mitigation,” *SPE, 19467*, 1989.
- [9] E. C. Capucci and K. V. Serra, “Transient Aspects of Unloading Oil Wells through Gas-Lift Valves,” *SPE Annu. Tech. Conf. Exhib.*, 1991.
- [10] D. Bertovic, D. Tulap, R. Blais, and Z. Schmide, “Calculating Accurate Gas Lift Flow Rate Incorporating Temperature Effects.” Oklahome, 1997.
- [11] T. Yula, S. Zelimir, R. N. Blais, and D. R. Doty, “Transient Dynamic Characteristics of the Gas-Lift Unloading Process (includes associated papers 57662 and 57711),” *SPE J.*, vol. 4, no. 3, 1999.
- [12] J. G. Faustinelli, P. Epm, and D. R. Doty, “SPE 69406 Dynamic Flow Performance Modeling of a Gas-Lift Valve,” 2001.
- [13] M. A. Shahri and H. W. Winkler, “SPE 141055 Practical Method for Measurement of Injection-gas Throughput of Each Gas-Lift Valve before Well Installation,” pp. 1–7, 2011.
- [14] F. Eildakli, M. Y. Soliman, M. Shahri, H. W. Winkler, and T. Gamadi, “Improved Gas Lift Valve Performance using a Modified Design for GLV,” no. Winkler 1987, 2014.
- [15] K. L. Decker and O. E. Corp, “SPE 25444 Gas-Lift Valve Performance Testing Why do we need performance data? The need for,” pp. 347–356, 1993.
- [16] F. Hover, E. Colina, F. Mode, A. Engineering, V. Shanghai, and E. Gilbertson, “Failure Mode and Sensitivity Analysis of Gas Lift Valve.,” 2014.
- [17] L. Guide, “PIPESIM Suite,” *Network*, pp. 1–61, 2003.
- [18] M. Jamal, *Gas lift Manual*, no. May. Briga- Libya: Sirte oil company, 1995.