

Cost-Effective Private Grid Using Object-based Grid Architecture

M. Victor Jose, V. Seenivasagam

Abstract—This paper proposes a cost-effective private grid using Object-based Grid Architecture (OGA). In OGA, the data process privacy and inter communication are increased through an object-oriented concept. The limitation of the existing grid is that the user can enter or leave the grid at any time without schedule and dedicated resource. To overcome these limitations, cost-effective private grid and appropriate algorithms are proposed. In this, each system contains two platforms such as grid and local platforms. The grid manager service running in local personal computer can act as grid resource. When the system is on, it is intimated to the Monitoring and Information System (MIS) and details are maintained in Resource Object Table (ROT). The MIS is responsible to select the resource where the file or the replica should be stored. The resource storage is done within virtual single private grid nodes using random object addressing to prevent stolen attack. If any grid resource goes down, then the resource ID will be removed from the ROT, and resource recovery is efficiently managed by the replicas. This random addressing technique makes the grid storage a single storage and the user views the entire grid network as a single system.

Keywords—Object Grid Architecture, Grid Manager Service, Resource Object table, Random object addressing, Object storage, Dynamic Object Update.

I. INTRODUCTION

THE main purpose of grid systems is to produce a universal infrastructure for computing and gathering distributed heterogeneous resources in an economical way. The limitation of the existing grid is that the user can enter or leave the grid at any time without schedule, which affects the architecture more. To overcome this limitation, the object-based architecture for grid computing can be introduced to do a secure communication on a public platform. In Object-based Grid Architecture, resources connected are treated as single components [1], [2], [4]. Similarly, the resources connected to the environment such as memory are also treated as single space which is shown in Fig. 1. Therefore, there is no need of costly memories. The OGA treats resources as a single unit so that processing time of input and output is reduced much. Massive computational problems are solved by making use of unused resources of disparate computers. In this, local service active protocol is introduced, which can act as the interface of the local system and MIS for registering the system

availability. The random addressing algorithm is discussed for data security and privacy. The organization of this paper is as follows. Section II introduces the architecture related to past research works. Section III describes the proposed, local service active protocol and add-file response function. Section IV describes OGA architecture with file system. Section V describes the algorithms of random resource selection, grid manager service and monitoring and information service. Section VI describes the implementation details. Section VII presents conclusions and potential future directions.

II. MATERIALS AND METHODS

A specialized biometric grid framework to advance educational collaborations and biometric data sharing is proposed [9]. It consists of four layers such as portal layer for control services, specific services layer for deployment of web services, platform layer for authenticated access and resources layer for computation [8]. This architecture is not feasible to all middlewares of the grid and its security is not ensured. A medical data manager to handle medical data on grids is suggested [10]. It guaranteed patients' privacy by keeping private data in acquisition centers in the form of encrypted data. This approach leads to higher complexity, for the specification maintenance of the access policies. Providing full access right by different services in the form of access control list is tedious. Virtual organization (VO) architecture for personal data involvement in grid and enhancing privacy is described [11] which is formed from different real entities and probably also from different communities (e.g. physicians and researchers working in specific projects). Access to data is normally organized around VO membership [6]. Each group can manage multiple ontologies and each ontology can be managed by different groups. In membership, there is no restriction. The drawback of this model is complicated data organization for resource providers. Key management policies are not efficient. Load acting as a resource tool for ERCOT (Electric Reliability Council of Texas) grid improves the system security through load contribution [12]. Based on the operation experience, load contribution idea has been implemented. It permits only qualified scheduling entities. A semantic component to support explicit conceptualization for suitable grid resources is suggested [13]. This semantic element has been incorporated with conservative grid schedulers. An explicit conceptualization is called ontology that facilitates the interchange and incorporation of information. Currently, for ontology development, web ontology language is used. Semantic component should be competent to integrate with dissimilar grid middlewares.

M. Victor Jose is with the Computer Science and Engineering Department, Noorul Islam Centre for Higher Education, Kumaracoil, Tamil Nadu, India (phone: +919487112584; Fax: +914651257266; e-mail: victorjose@yahoo.com).

V. Seenivasagam is with the Computer Science and Engineering Department, National Engineering College, Kovilpatti, Tamil Nadu, India (phone: +919442622502; Fax: +914632232749; e-mail: yespee1094@yahoo.com).

Architecture of semantic grid consists of fabric layer, core middleware layer, high-level middleware layer and application layer. Fabric layer provides access to the resources. Middleware layer provides secure and unified access to remote resources. High-level middleware layer's primary component is scheduler that selects the suitable resources that fulfill the user requirements and schedule the job. The discovery portal enables the resources through resource access protocols. This semantic component performance is less compared with other security components. The drawback of this scheme is complex processing and less performance. A novel approach with advanced security mechanism, which permits the users to use custom software on demand, is discussed [14]. An automated dynamic firewall mechanism enables virtual organization and

user network security setups, not to allow network regions on demand. Additionally, to secure group of local resources, this environment is split into several zones. Using extension of business process execution language, this environment and existing business processes are integrated together. A proxy certificate creation and renewal are dealt by workflow engine. This is not tested for all environments. This needs a trusted domain. A privilege management infrastructure for healthcare grid is proposed [15]. Its tasks are provision of an efficient VO management of users, assignation of roles to users, assignation of privileges to roles, and definition of resource access policies [6]. In this model, security enhancement techniques are not discussed.

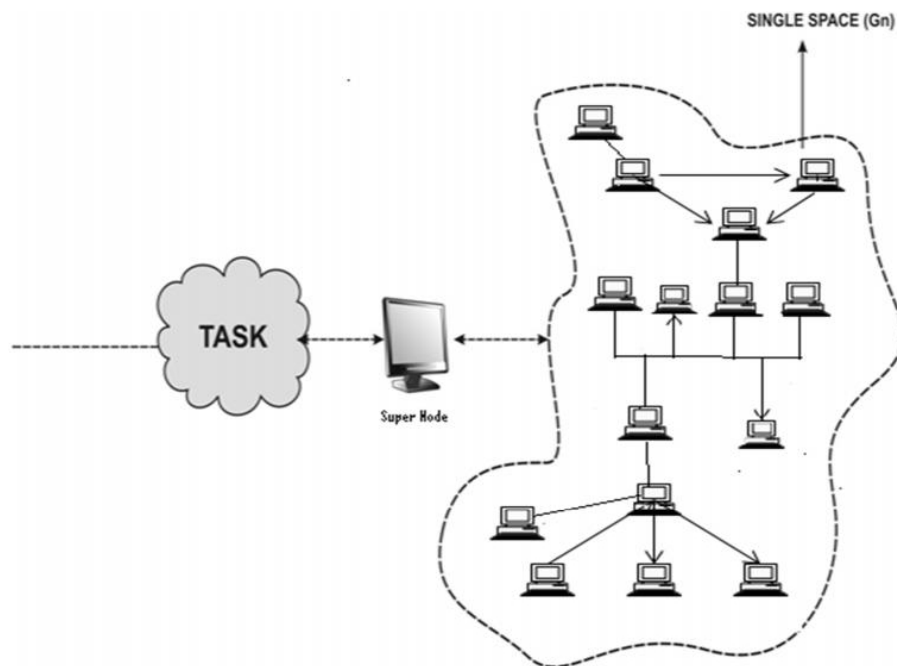

Fig. 1 OGA architecture

III. THE PROPOSED WORK

A. Local Service Active Protocol

In this design, the grid manager service running in local system can act as grid service [1]. When the system boots, grid manager service will get loaded into memory and send a registration message to the middleware or monitoring and information system. That message contains resource ID and the resource object. The resource object contains information about grid resources and response counter. The resource object table is a directory structure where object for each grid resource will be stored. The resource object table is maintained in MIS. For every two minutes, the response counter of resource sends registration message to MIS. After receiving the registration message, MIS sends the acknowledgement to the response counter of the resource. After receiving acknowledgement from MIS, the response

counter gets to reset and incremented, and this process is repeated. The whole task is done by Local Service Active Protocol (LSAP) which acts as a bridge between the local platform and MIS. Fig. 2 is the sequence diagram of LSAP which explains the detailed flow of the tasks.

B. Add-file Response Function

In the grid network, the user application should have information about the available resources and storage resources. The user should specify where the file could be stored. But in this design, the user need not mention the storage resources. MIS will take care of assigning storage resources to the user using the add-file response process. This function automatically checks the response of the resource. If the resource is active, then the MIS will randomly add the resource to storage. Therefore, the grid user has a virtual feeling to work as a single resource. For example, MIS will

take care of assigning resource-2 to user application as add-file response process is explained in sequence diagram as shown in Fig. 3. In this design, every grid node contains a grid

manager service. It contains timer service and response checking service.

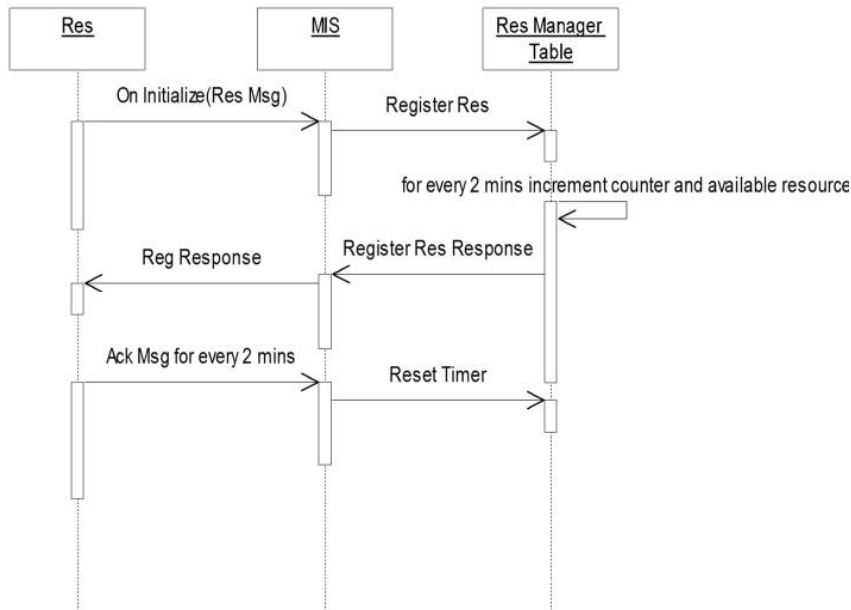

Fig. 2 Sequence Diagram of LSAP

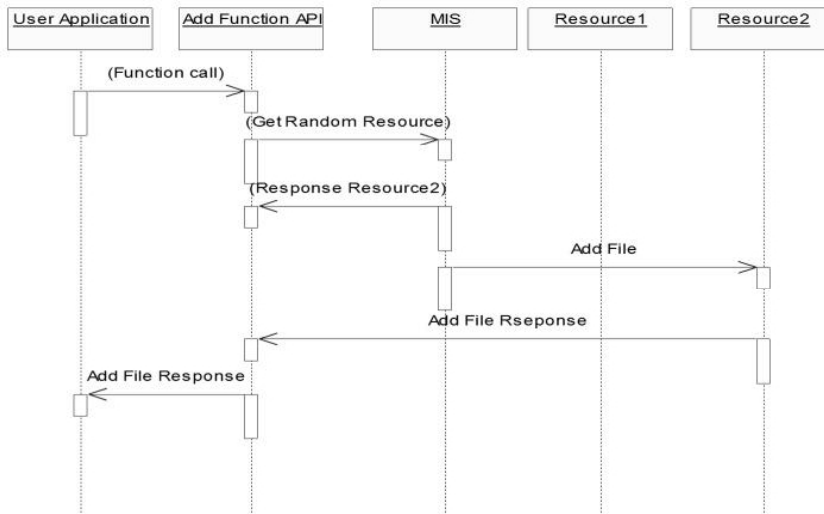

Fig. 3 Sequence diagram of add-file response

IV. OBJECT-BASED GRID ARCHITECTURE

A. Global Grid Strength

The global strength of the grid (G_i) is a collection of resources from the system platform. That is, $G_i = g_{N1} + g_{N2} + \dots + g_{Nn}$. In this node, (g_{Nn}) will get updated in a global object of the Monitoring and Information System (MIS) or a controlling middleware server. When the job allocation process begins, it can be reflected in the global strength of the objects. The object will get updated dynamically when the changes are made by the administrator. The change in the grid

resource is reflected in the middleware. The system platform carries the changes made by the resource administrator, and the grid platform handles the other events of the change made by the administrator. The global grid strength (G_i) of OGA is shown in Fig. 4.

B. Global Grid Platform

The OGA provides a single space grid platform to enhance the privacy in grid computing. Each node in the grid space is considered as the object in the MIS, and the authentication process will be done in the MIS [7]. During the authentication

process, the MIS will authenticate the requester with the grid node using the grid node objects [3].

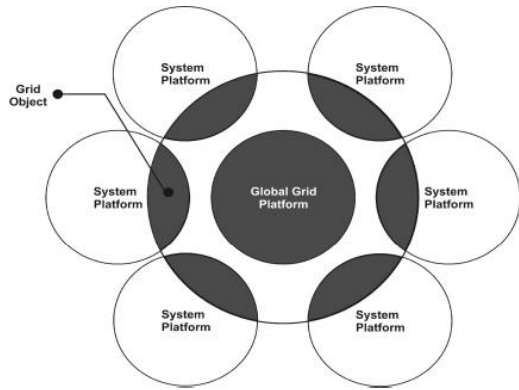

Fig. 4 Global Grid Strength of OGA

A user entering the grid space can feel the reality of grid through the MIS virtual interface, but this interface is a dynamic object maintained by the MIS and by the corresponding grid node. All the resources were treated in a single space. The node (gNn) connected with the grid environment has a separate partition for grid objects according to the resource administrator allocated, which is shown in Fig. 5.

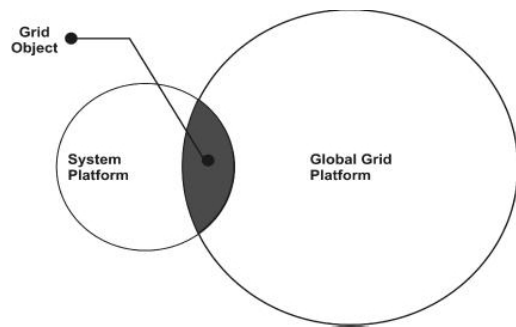

Fig. 5 Partition for grid objects

C. Grid File System

The grid file system is classified into global grid file system and local grid file system. In the global file system, the entire data will be partitioned according to the grid strength. After forwarding the data, it reaches the grid (Gi) and the grid will take care of the data to store (gNi) in its local partition. Each local grid node is partitioned into system data partition and grid data partition, according to the suggestion [5], which is shown in Fig. 6. In the same way, the grid platform will act as the separate operating system and perform the grid jobs in a secure way.

The global grid file system treats each gNi as a sector and makes it a virtual single track as shown in Fig 7. Suppose a file size of n needs to be stored, it can be divided into n parts according to the sector strength. Then, the file will be sent to each sector to store the data, and the address will be globally maintained in the global grid file system table in the control

server. The global grid file system runs on the grid environment along with each gNi. Since each gNi has its own data partition, the grid objects are considered as a single entity.

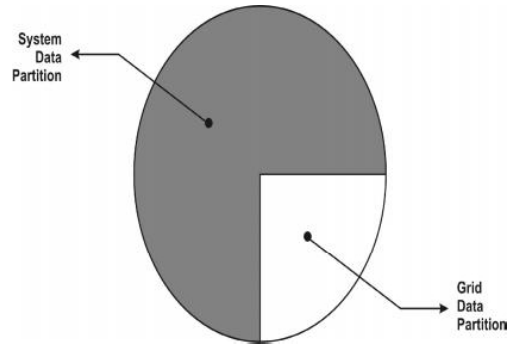

Fig. 6 Local grid system

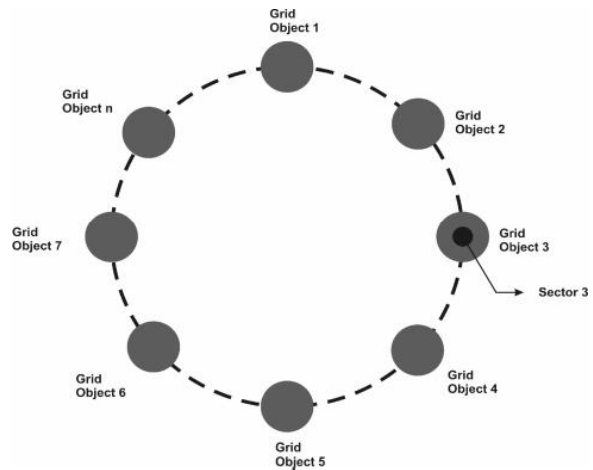

Fig. 7 Global grid file system

The local grid file system runs on appropriate nodes (gNi) only. The local grid file system is used to handle the incoming data or outgoing data to store locally on the memory devices such as hard disk. When the grid user requests the file, the global grid file system tracks the sectors and finds the file. That is returned locally by the local grid file system. The local grid file system also maintains a local grid file system table to process the data.

D. Local Grid Manager Protocol

Local grid manager protocol acts as the bridge between the local platform and grid platform that is shown in Fig. 8. When the grid user works on the local platform, the grid platform will get entirely detached from the control. When the user works on the global grid platform, the local grid node does not know what happens in the grid environment and the user has no provisions to read the data or trace the process. A grid object is responsible for the gNi node. The gNi object consists of all instances of resources. All the resources are invoked by using the grid object only.

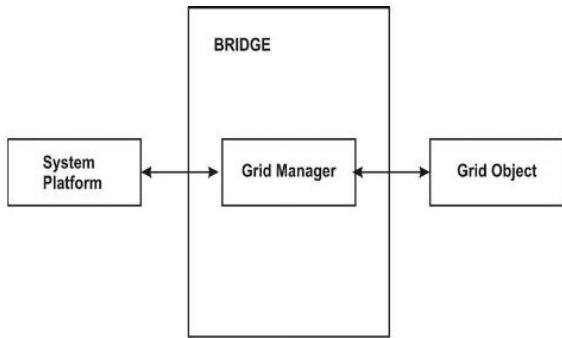

Fig. 8 Local grid manager protocol

E. Dynamic Object Update Process

Each object on the gNi can dynamically get updated to the MIS. The object consists of many resources associated within it such as memory, processor, etc. The administrator is the only person having the right to increase or decrease the resources based on usage. For example, the CPU usage is 25%, but the administrator is willing to increase the usage level to 35%. Then, the increased percentage value will get updated dynamically. The dynamic object update process is shown in Fig. 9. To handle the entire dynamic event, the dynamic object update is handled globally.

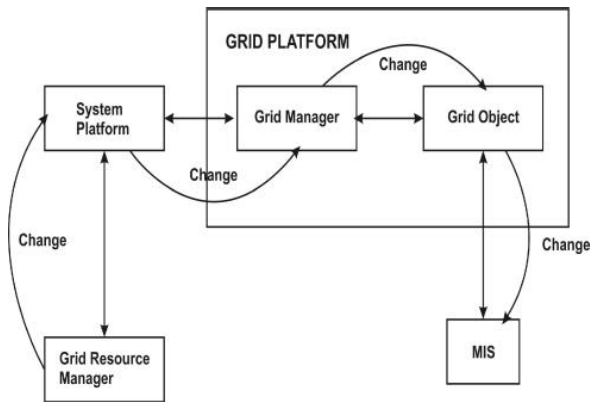

Fig. 9 Dynamic Object Update

V. ALGORITHMS

A. Random Resource Selection

The following is the pseudo code function of random resource selection to prevent stolen attack. Let Threshold = 2sec be an ideal time permitted by the designer.

```

Function Get_Random_Resource ( )
Random resources ← Rand (1, No. of resources)
Index ← READ Random resources
IF (Response count < Threshold)
THEN REMOVE Random resource
ELSE
Index ← Random resource
ENDIF
RETURN Resource index
End Function
    
```

B. Grid Manager Service

The following is the procedure of grid manager service in local node.

```

Procedure Grid_manager_service ( )
Activate Registration Message (Total allotted resources, Available resources)
Get (Acknowledgement from MIS, Unique resource ID)
Initialize Heartbeat Timer
Begin
Activate Heart Beat Message (Unique Resource ID, Total Allotted resources, Available resources)
End
Initialize Request_on_Queue
Begin
If (Request type = valid) then
Begin
If (Resource = Available) then Perform Received Request
Else Activate Response Message (Request Info, Identifier, ErrCode of Out of Resource)
If (System function fails) then Activate Response Message ( ErrCode of SysCall failure)
Else Activate Response (Request Info, Identifier, Success Code, Total allotted resources, Available resources)
End
Else Activate Response with ErrCode
End
End Procedure
    
```

C. MIS Service

In the middleware, the monitoring and information system service contains Resource Table Manager (RTM) and request processor service. The following is the procedure of monitoring and information system service in middleware.

```

Procedure of MIS Service ( )
Begin
Initialize Resource table
Initialize RTM
Activate RTM Timer
Begin
FOR i ← 1 TO No. of resources
Heartbeat Message counter (i) ← Heartbeat Message counter(i) +1
IF (Heartbeat Message counter < Threshold)
THEN REMOVE from Resource table
ENDIFOR
End
Initialize Request Processor
Activate Request Processor
IF (Message = 'Registration Request Message') then
Begin
Perform new resource ID using random addressing
Add resource table
Activate response with the new resource ID
End
Else IF (Message = 'Heartbeat Message') then
Begin
Perform Heartbeat Message counter ← 0
Append Resource table entry
End
Else IF (Message = 'Operation Request Message') then
Begin
    
```

```

IF (Valid User) then Activate response with request Identifier
Else Activate ErrCode Corresponding to Invalid User
IF (Valid Request) then Activate response with request Identifier
Else Activate ErrCode Corresponding to Invalid Request
End
Else IF (Message = 'Operation Response Message') then
Begin
IF (Response = 'Success' OR 'Error code') then Activate the
response to the Client
IF (Client info = Request info) Append the resource table information
End
Else IF (Find the required Resource) then
Begin
Perform the requested operation
Activate response with request identifier
End
Else
Activate ErrCode Corresponding to Out of resource
ENDIF
End
End Procedure

```

VI. IMPLEMENTATION AND DISCUSSION

The single storage grid is simulated in GridSim Toolkit 5.2 with various criteria and the results have been verified. In this design, the user is not aware of grid resources for the storage purposes. MIS will take care of assigning resources to the grid based on the availability of the local resources. That is why the grid user has a feeling to work as a single resource. The procedure Get_Random_Resource is used to select random resources for storage. The procedure of grid manager service in local grid node is used to minimize the entry to/ exit from the grid. The procedure of monitoring and information system service in middleware is used to manage all types of grid tasks, which is improving the security and privacy and prevents the attacks. The resource object table is a directory where the object of each grid resource will be stored. The RTM maintained in MIS for every two seconds is registered to MIS. After receiving the registration, the resource sends an acknowledgement to MIS then resets the response counter and the process is repeated. In this design, MIS would take care of assigning resource for storage purposes. To prevent the stolen attack, it uses random addressing.

VII. CONCLUSION

This paper contributes cost-effective private grid using OGA. This local service active protocol is used for grid data partition, session-based grid instance, random addressing technique and object-based conversion and access. Privacy has been increased, reducing the need for massive re-encryption. Our grid acts as middle layer of the grid and cloud. In future, it is possible to create economy cloud also by using this idea.

REFERENCES

- [1] M. Victor Jose, and V. Seenivasagam, "Object Based Grid Architecture for Enhancing Security in Grid Computing," in *2011 IEEE Proc. ICSCCN*, pp 414-417.
- [2] Foster, Ian, "Globus Toolkit Version 4: Software for Service-Oriented Systems," *IFIP Int. Conf. on Network and Parallel Computing*, Springer-Verlag LNCS 3779, pp 2-13, 2005.
- [3] Foster Ian, "WS-Resource Framework: Globus Alliance Perspectives," GlobusWORLD, Jan 2004.
- [4] I. Foster, C. Kesselman, and S. Tuecke, "The Anatomy of the Grid: Enabling Scalable Virtual Organizations". *International Journal of High Performance Computing Applications*, vol. 15, no. 3, pp. 200-222, 2001.
- [5] K. Keahey, T. Fredian, D.P. Peng, M. Schissel. Thompson, I. Foster, M. Greenwald, and D. McCune, "Computational Grids in Action: The National Fusion Collaboratory", *Future Generation Computer System*, vol. 18, no. 8, pp. 1005-1015, Oct. 2002.
- [6] I. Blanquer, V. Hern'andez, D. Segrelles, "Enhancing Privacy and Authorization Control Scalability in the Grid Through Ontologies" *IEEE Tansactions on information technology in biomedicine*, vol. 13, no. 1, PP 16-24, Jan 2009.
- [7] M. Victor Jose, and V. Seenivasagam, "Four Factor Secure Authentication and Authorization for Economic Grid," *Research Journal of Applied Sciences, Engineering and Technology*, vol. 7, no. 11, PP. 2253-2260, March 2014.
- [8] M. Victor Jose, and V. Seenivasagam, "Enhancing Security in Resource Sharing Using Key Holding Mechanism," *World Academy of Science, Engineering and Technology, International Journal of Computer, Information Systems and Control Engineering*, vol. 8, no. 10, pp. 1691-1697, Dec 2014.
- [9] Anlong Ming, and Huadong Ma, 'The Biometrics Grid: A Solution to Biometric Technologies', *IEEE Distributed Systems Online*, vol. 8, no. 9, pp. 1-14, 2007.
- [10] J. Montagnat, A. Frohner, D. Jouvenot, C. Pera, P. Kunszt, C. L. Texier, P. Guio, R. B. Rocha, S. Almeida, and, Z. Farkas, "A Secure Grid Medical Data Manager Interfaced to the gLite Middleware", *Journal of Grid Computing*, vol. 6, no. 1, pp. 45-59,2008.
- [11] I. Blanquer, V. Hernandez, and D. Segrelles, "Enhancing Privacy and Authorization Control Scalability in the grid through Ontologies", *IEEE Transactions on information technology in biomedicine*, vol. 13, no. 1, PP. 16-24, 2009.
- [12] Shun-Hsien Huang, John Dumas, Carlos González-Pérez and Wei-Jen Lee, "Grid Security through Load Reduction in the ERCOT Market", *IEEE Transactions on Industry Applications*, vol. 45, no. 2, pp. 555-559, 2009.
- [13] B. R.Amarnath, S. Thamaraiselvi, M. Ellappan, and R. Buyya, "Ontology-based Grid resource Management", *Software Practice and Experience*, vol.39, no.17, pp. 1419-1438, 2009.
- [14] M. Smith, M. Schmidt, N. Fallenbeck, T. Dörmemann, C Schridde, and B. Freisleben, "Secure on-demand grid computing", *Future Generation Computer Systems Journal*, vol. 25, no. 3, pp. 315-325, 2009.
- [15] J. Calvillo, I. Roman, S. Rivas, and L.M. Roa, "Privilege Management Infrastructure for Virtual Organizations in Healthcare Grids" *IEEE Transactions on information technology in biomedicine*, vol. 15, no. 2, pp. 316- 323, 2011.



M. Victor Jose received his BE degree in Computer Science and Engineering from Manonmaniam Sundaranar University, Tamil Nadu, India in 1995 and ME degree in the same discipline from Madurai Kamaraj University, Tamil Nadu, India in Nov. 1996. He is currently pursuing his Ph.D. degree at the Department of Computer Science and Engineering, Anna University, India. His research interests include Grid computing, Network security, Data base security, and Multimedia wireless communications. Email_id: mvictorjose@yahoo.com.



V. Seenivasagam is the Controller of Examinations in National Engineering College (Autonomous), Kovilpatti. He has obtained his B.E. Degree in Computer Engineering from Madurai Kamaraj University during the year 1989, M.E. and Ph.D degree in Computer Science & Engineering from Manomaniam Sundaranar University in 1997 and 2009 respectively. Dr.V.Seenivasagam has 24 years of experience in teaching and 12 years of experience in research. He has published 16 papers in International Journals, 1 paper in National Journal, and

presented 9 papers in International Conferences and 34 papers in National Conferences. He is the recognized supervisor in Anna University of Technology, Tirunelveli and Manonmaniam Sundaranar University, Tirunelveli. At present, 14 scholars are doing research under his guideship. He has attended many Faculty Development Training Programmes and chaired many international and national conferences and symposiums. He has delivered guest lectures on different topics of Image Processing at various Engineering and Arts Colleges. He has written books on Computer Graphics, Software Engineering, Digital Computer Fundamentals and Fundamentals of Computing and Programming. He is the reviewer for reputed international journals such as International Journal on Image and Video Processing, International Journal of Pattern Recognition and Artificial Intelligence, International Journal of Association of Modeling Simulation Enterprise and International Journal of Information Technology & Decision Making. He is the member of Board of Studies in the faculty of Computer Science and Engineering at Anna University of Technology, Tirunelveli. His areas of specializations are Image Processing, Compiler Design and Soft Computing, Email_id: yespee1094@yahoo.com