

Application of Artificial Neural Network in the Investigation of Bearing Defects

S. Sendhil Kumar, M. Senthil Kumar

Abstract—Maintenance and design engineers have great concern for the functioning of rotating machineries due to the vibration phenomenon. Improper functioning in rotating machinery originates from the damage to rolling element bearings. The status of rolling element bearings require advanced technologies to monitor their health status efficiently and effectively. Avoiding vibration during machine running conditions is a complicated process. Vibration simulation should be carried out using suitable sensors/ transducers to recognize the level of damage on bearing during machine operating conditions. Various issues arising in rotating systems are interlinked with bearing faults. This paper presents an approach for fault diagnosis of bearings using neural networks and time/frequency-domain vibration analysis.

Keywords—Bearing vibration, Condition monitoring, Fault diagnosis, Frequency domain.

I. INTRODUCTION

CONDITION MONITORING (CM) is used extensively in various industries which are continuously under economic pressure to reduce costs of service and productivity. Hence, CM is increasingly becoming an important asset management tool. Simulation of vibrations can be used to assist in the rolling bearing fault diagnosis strategies. Simulation and real-time testing results obtained can be effective in the diagnosis of various motor bearing faults. An introduction to vibration data analysis is discussed briefly along with the basic knowledge [1]. The acceleration signal emitted from ball bearing is processed as a simple method. Low cost equipments can be fabricated for monitoring the initiation and progress of the damage and predicting the necessity of bearing replacement [2]. The life prediction of a ball bearing's based on self-organizing map (SOM) and back propagation neural network methods was discussed in [3]. Sensors signals due to vibration are captured and compared with reference measurements to interpret bearing conditions. Among the different approaches, the frequency analysis approach is the most popular one and discussed [4]. The acceleration signals from a normal bearing and two different defective bearings under various loads and speed conditions are collected and processed further in a neural network efficiently [5]. An experiment has been conducted using vibration analysis for predicting shaft misalignment [9], [11]. The experimental and numerical frequency spectra were obtained and validated [6]. Application of artificial neural network and wavelet transform

S. Sendhil Kumar, Assistant Professor, is with the Karpagam Institute of Technology, Coimbatore, India (e-mail: ssk333c@yahoo.co.in).

M. Senthilkumar, Associate Professor, is with the PSG Institute of Technology, Coimbatore, India.

for vibration analysis is discussed for combined faults of unbalances & shaft bow [7]. Back propagation neural network has been used for prediction of a rotating mechanical system at the bearing points using real data for all directions. This kind of neural network predictors would be designed as a controller [8].

II. DESIGN OF EXPERIMENTAL SET UP

A bench top experimental setup has been used to detect the bearing defects as shown in Fig. 1, which consists of an AC motor (1), a self designed coupling (4), a single-disk rotor (6). The shafts of length 900mm, 12mm in diameter is supported by three identical pillow radial bearings (3, 5, and 7) located at a distance of 100,300 & 900 mm respectively. A disk of outer diameter 50 mm, weighing 1Kg is mounted on the mid-way of the bearing supports (5&7). The specifications of the bearings used in this test rig are shown in Table I.

TABLE I
SPECIFICATIONS OF BEARINGS

Type of bearing	UC202
No of Balls	8 Balls
Pitch diameter, mm	15
Ball diameter, mm	10
Inner diameter, mm	12
Outer diameter, mm	47

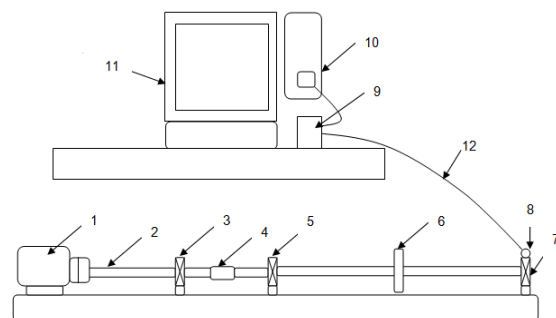

Fig. 1 Experimental Setup [10]

The steel base plate holds the bearing pedestals and motor support. Using the radial screws the disk is fastened to the rotor shaft. The speed is measured using a tachometer and is varied by adjusting the power supply to the motor. For the detection of the bearing defects, the accelerometer (8) make DyTran 3097 A2, 96.72mV/g sensitivity and Data acquisition card (9) DAQ NI 9234 are used to acquire and transform the vibration signals from bearing. The accelerometer is placed

vertically over the bearing mounting and the frequency response, Velocity RMS value, displacement value have been captured from the drive end, coupling end and non-drive end of test rig.

III. DIAGNOSIS OF THE BEARING DEFECTS

The ball bearings themselves act as a source of vibration, even in the absence of defects. The level of vibration can be increased due to the defects on one of the elements of a ball bearing. An impulse is created when a rolling element strikes to a defect on one of the races, which are periodic with a certain frequency due to the rotation. Inner or outer race defect, repeated after each rolling element striking is known as “Ball-pass frequency”. In a bearing–rotor system, the speed of the rotor (or shaft) F_s is very important for the movements of bearings. Ball pass inner raceway frequency FBPI, all pass outer raceway frequency FBPO are a function of this frequency. The value FBPO is a function of the number of bearing balls NB and the difference between the outer raceway frequency and the fundamental cage frequency F_c . The ball rotational frequency FB is the rate of rotation of a ball about its own axis in a bearing. This frequency can be calculated from either the ball pass inner raceway frequency FBPI or ball pass outer raceway frequency FBPO. The vibration signals from bearings with inner and outer race fault can be compared with fault-free bearing. Impulses from a defect in outer race have approximately equal amplitudes. Impulses created from a defect on the inner race have different amplitudes but still periodic. The behavior can be fulfilled as the impulses are amplitude modulated. The impulses arise due to resonance from bearing elements, the amplitude is directly related to the applied force on the ball bearing. Since the impulses are of short duration, the spectra exhibit many harmonics. The amplitude of the defect is useful for effective decision making.

$$F_{BPO} = \frac{N_B}{2} F_s (1 - \frac{D_b \cos \theta}{D_c}) \tag{1}$$

$$F_B = \frac{D_c}{2D_b} F_s (1 - \frac{D_b^2 \cos^2 \theta}{D_c^2}) \tag{2}$$

IV. PROGNOSIS OF THE BEARING DEFECTS

Back propagation (BP) is used as a learning algorithm to implement and often performs well in comparison to other methods [8]. In this paper neural networks is used to perform the bearing fault diagnosis based on the data’s captured through accelerometer. The neural network has been developed using a toolbox available in MATLAB. The details of the neural network are shown in the Table II. The development details of neural network are shown in Fig. 2.

TABLE II
DETAILS OF NEURAL NETWORK

Network	Parameters
Type of algorithm	Feed forward back propagation
Number of hidden layers	3
Number of neurons in each layer	10
Transfer function	TANSIG

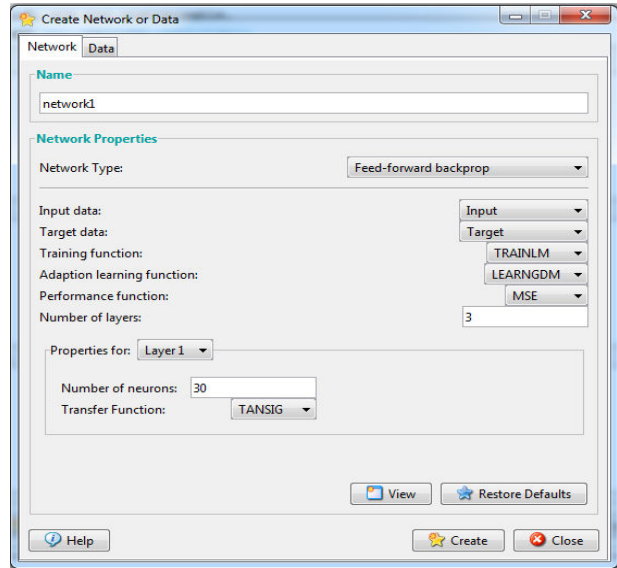

Fig. 2 Creation of Neural Network

V. RESULTS AND DISCUSSION

The design of experiment was done using the lab view program based on the literature review. The spectral comparisons were made across the three bearing ends (DE, CE & NDE). Defect frequencies can be computed analytically as a function of the shaft rotational speed, which rotates at a frequency depending on the running condition, and a function of the ball diameter, pitch diameter, and number of balls. The major objective of this research paper is to study the effects of bearing defects. A base line data is captured for a non-defective bearing, which can be used for further comparison of spectrum of the test rig while it is simulated with defects. The frequency spectrum of the non-defective bearing is shown in Fig. 3. A bearing having a defect in the outer race is placed in the coupling end of test rig; the spectrum is captured and shown in Fig. 4. Theoretical calculation is done using (1), and defective frequency is 36.12 Hz. Table III shows the analytical and experimental results for outer race defect for various running speeds. Later the bearing is replaced with the ball defective bearing and its spectrum is shown in Fig. 5. The analytical and experimental values of ball defect frequencies are tabulated in Table IV.

TABLE III
RESULTS OF OUTER RACE DEFECTIVE BEARING FREQUENCIES

S.No	Speed (RPM)	Theoretical Calculation Hz	Experimental Calculation Hz
1	750	36.12	38.12
2	1000	48.14	50
3	1300	64.03	62.24
4	1500	72.22	74

The performance of the developed neural network model is shown in Fig. 6. The bearing characteristic frequency was calculated and this value was found to be 48.14Hz, whereas the obtained practical value is 50 Hz. These values are

depicted in Table III. It summarizes the peaks obtained and the respective magnitudes obtained. The input to neural network is shaft speed, velocity RMS value, coupling misalignment value. Neural networks have been used to perform machine bearing fault diagnosis based on the extracted information features. Actual bearing vibration data collected in real-time were then applied to perform initial testing and validation of the approach. The regression plot of the neural network is shown in Fig. 7.

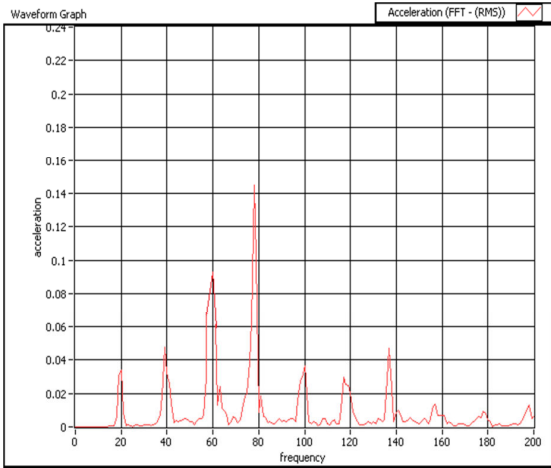

Fig. 3 Spectrum of Good bearing

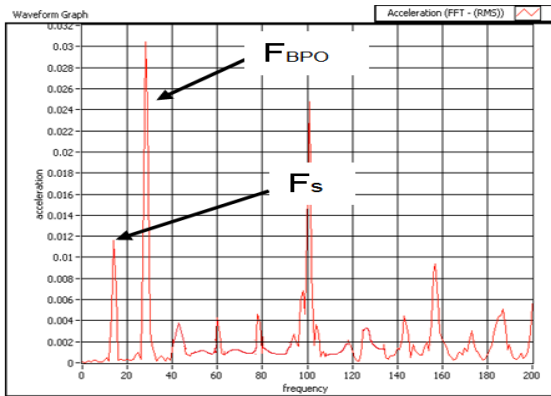

Fig. 4 Spectrum of Outer race defective bearing

TABLE IV
RESULTS OF BALL DEFECT BEARING FREQUENCIES

S.No	Speed (RPM)	Theoretical Hz	Experimental Hz
1	750	20.76	22.2
2	1000	27.68	29.2
3	1300	36.82	35
4	1500	41.52	42.44

The validation result is also shown in Fig. 8 which illustrates the results of ball defect bearing (0 0 1) and the outer race defect (0 1 0) the neural networks can be used in the diagnosis of various bearing faults.

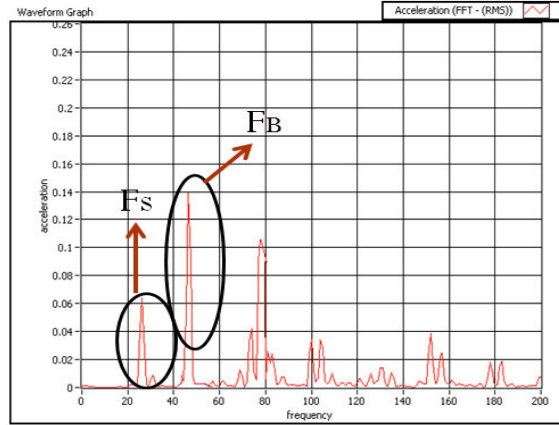

Fig. 5 Spectrum of Ball defect bearing

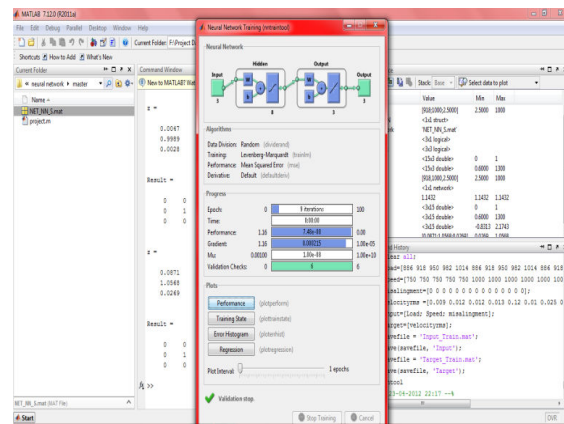

Fig. 6 Neural Network Train Model

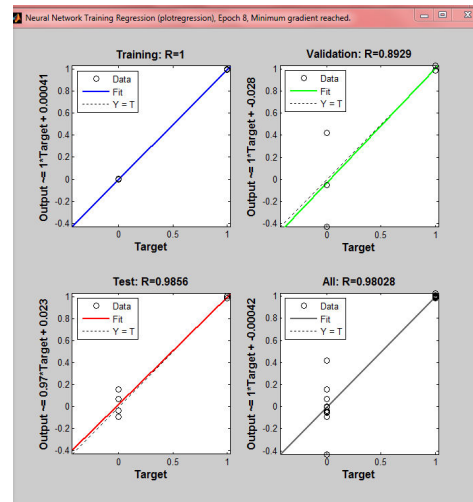

Fig. 7 Training Regression Plot

VI. CONCLUSION

The vibration monitoring test rig developed with various modes of machine failure is indeed capable of independently generating common machine faults. The base signal was found

to be within the safe limit as per the vibration severity chart. The various faults are stimulated in the test rig correspondingly; the vibration frequency signals are extracted. The theoretical predictions are in good agreement with the experimental measurements based on the results shown in Tables III & IV. This information gives the knowledge of the velocity pattern across the rotor. The results show that neural networks can be effectively used in the diagnosis of various machine bearing faults through appropriate measurement and interpretation of machine bearing vibration signals. The performance of the back propagation neural network in recognizing ball bearing states has been found to be exceptionally good. Moreover, the network is capable of estimating the different ball bearing states (having different localized defects) for diagnostic purposes.

- [8] Menderes Kalkat, Sahin Yildirim & Ibrahim Uzmay, Design of artificial neural networks for rotor dynamics analysis of rotating machine system, *J Brazil Soci Mech Engrs*,15, 573-588,2004 .
- [9] M.Senthil Kumar & S.Sendhil Kumar, Effects of misalignment & Unbalance in a vibration analysis of a rotor-bearing system, *National journal of Technology*, Vol 8, No 1,ISSN 0973 1334, 14-20, Mar 2012.
- [10] S.Sendhil kumar, M.Senthil Kumar, "Investigation of bearing faults using LABVIEW", *International journal of Information Technology & Computer sciences Perspectives* 2219-9016, Vol 1, No1, 208-211, Oct-Dec'2012
- [11] M.Senthil Kumar, S.Sendhil Kumar, "Condition monitoring of rotating machineries through vibration analysis" *Journal of Scientific and Industrial Research*, 0022-4456, Vol 73,258-261, April'2014.

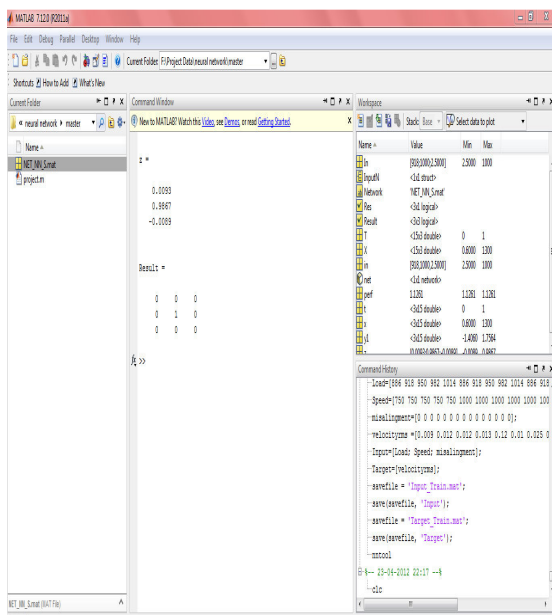

Fig. 8 Validation result

REFERENCES

- [1] R. Keith Mobley Boston, "Vibration Fundamentals Part II", Butterworth-Heinemann, 1999.
- [2] T. Hoshi, "Damage Monitoring of Ball Bearing", Technical Research, Toyohashi, Japan 2005.
- [3] Runqing Huang, Lifeng Xia, Xinglin Lib, C. Richard Liuc, Hai Qiud, Jay Lee, "Residual life predictions for ball bearings based on self-organizing map and back propagation neural network methods"
- [4] Sebastian Willwock and Henning Zoubek Student Member, IEEE, Mario Pacas Senior Member IEEE, University of Siegen "Rolling Bearing Condition Monitoring Based on Frequency Response Analysis" *Institute of Power Electronics and Electrical Drives Holder 3, IEEE 2007 vol no 4.1.0*
- [5] M. Subrahmanyam and C. Sujatha "Using neural networks for the diagnosis of localized defects in ball bearings" *Tribology International* Vol. 30, No. 10, pp. 739-752, 1997.
- [6] V. Hariharan and PSS. Srinivasan "Vibration Analysis of Shaft-ball Bearing System" *Indian Journal of Science and Technology*, Vol.2 No. 9 Sep 2009
- [7] H.K.Srinivas, K.S.Srinivasan & K.N.Umesh, Application of artificial neural network and wavelet transform for vibration analysis of combined faults of unbalances & shaft bow, *Adv.Theor.Appl.Mech*, Vol 3, 2010.