

# Transient Stability Improvement in Multi-Machine System Using Power System Stabilizer (PSS) and Static Var Compensator (SVC)

Khoshnaw Khalid Hama Saleh, Ergun Ercelebi

**Abstract**—Increasingly complex modern power systems require stability, especially for transient and small disturbances. Transient stability plays a major role in stability during fault and large disturbance. This paper compares a power system stabilizer (PSS) and static Var compensator (SVC) to improve damping oscillation and enhance transient stability. The effectiveness of a PSS connected to the exciter and/or governor in damping electromechanical oscillations of isolated synchronous generator was tested. The SVC device is a member of the shunt FACTS (flexible alternating current transmission system) family, utilized in power transmission systems. The designed model was tested with a multi-machine system consisting of four machines six bus, using MATLAB/SIMULINK software. The results obtained indicate that SVC solutions are better than PSS.

**Keywords**—FACTS, MATLAB/SIMULINK, multi-machine system, PSS, SVC, transient stability.

## I. INTRODUCTION

MODERN power systems are increasingly complex nonlinear interconnected networks comprising interconnected generator power plants, transformers and transmission lines with differences in loads. The interconnection of smaller subsystems is beneficial in reducing operating costs (e.g. fuel costs, sharing resources) and diversity of loads improves the reliability of the system [1]. However, this poses technical challenges such as low frequency electro-mechanical oscillation caused by electrical disturbances [2]. The power system stability is the ability of the system to return to its original operating condition after a disturbance [3]. In modern power systems, increased power demand result in long transmission lines being overloaded (above normal limits), exacerbating the problem of transient stability, which has become a serious limiting factor in electrical engineering.

The transient stability of a system defined as the ability of the system to maintain a stable condition after large disturbances, like fault and switching of lines. There are several methods for improving transient stability, including circuit breakers, fast-acting exciters and reduction in the transfer reactance of the system [1]. Under small disturbances, to remain synchronized the machine requires positive damping, generally from a power system stabilizer (PSS) provides positive damping to the system, which has been one

of the most common controls used to damp out oscillations,. The main role of PSS is to introduce modeling signal acting through the excitation system for oscillation damping [4]. It must be capable of providing stabilization signals over a broad range of operating conditions and disturbances; however, within nonlinear systems, the function of PSS is limited [5].

Many complex power systems are now stabilized using Flexible Alternating Current Transmission System (FACTS), which can control network conditions with optimum speed and enhance transient, voltage and steady state stabilities [6].

There are numerous categories of FACTS controllers, including shunt, series, combined series-series and combined series-shunt types. FACTS devices include a group of multiple controllers to control system parameters such as phase angle, damping oscillation at different frequency, voltage, current and impedance [7]. In this paper, the static Var compensator (SVC) is discussed. It is a shunt type, connected as a controller that enhances the transient stability and damping the power oscillation with more reliable operation [8], [9]. A MATLAB/Simulink mode is developed for a multi-machine system consisting of a four machine six bus test system used to perform the simulation studies. The results obtained with SVC are very reliable for damping oscillation with disturbances and other parameters such as terminal voltage can be explored.

The organization of this paper is as follows: Section II explains power system stability; Section III power system stabilizer PSS structure and the effect of damping oscillation; Section IV models of static Var compensator SVC and explains SVC principles and its effectiveness to improve damping oscillation and explain the structure of the SVC controller; the system is explained by using MATLAB/Simulink to create a three phase fault in the test system, as explained in Section V; and Section VI presents the conclusion of the work.

## II. POWER SYSTEM STABILITY

The property of a power system that enables it to remain in state operating equilibrium under normal operating condition and revert to an acceptable state of equilibrium after being subjected to a disturbance is defined as its stability. There are many different sources of instability in a power system, depending on configuration and operating mode. In the evaluation of stability, the main concern is the behavior of the power system when subjected to a transient disturbance [3].

Khoshnaw Khalid Hama Saleh, Ergun Ercelebi are with the Department of Electronic Engineering, Gaziantep University, Gaziantep, Turkey (e-mail: khoshnaw982@yahoo.com, ergun.ercelebi@gmail.com).

The classification of power system stability proposed here is based on the following considerations:

- The physical nature of the resulting instability;
- The size of the disturbance considered;
- The devices, processes and time span; and
- The most appropriate method of calculation and prediction of stability [3].

There are highly nonlinear power systems that function in a constantly changing environment in terms of loads, generators, outputs and key operating parameters; the system stability depends on the conditions of initial operation and the disturbance nature. Typically, power system stability is classified into steady state stability, transient state stability and dynamic state stability.

- Steady state stability: this is the capability of an electrical machine of power system to return to its original/previous status. The power transferred by the generator to the power system is equivalent to the mechanical power implemented by the prime mover, ignoring loss.
- Transient state stability: following a significant disturbance, the synchronous alternator the machine power (load) angle changes as a result of immediate acceleration of the rotor shaft. The transient stability could determine whether the load angle returns to a steady value following the clearance of the disturbance. Transient stability is a rapid phenomenon, normally happening within one second for a generator close to the cause of disturbance.
- Dynamic state stability: this is the ability of a power system to maintain stability under continuous small disturbances. Dynamic instability is more probable than steady state stability. Small disturbances are continually occurring in power systems (e.g. due to various loadings and changes in turbine speeds), which are small enough not to cause the system to lose synchronism, but they do excite the system into the state of natural oscillations.

### III. POWER SYSTEM STABILIZER (PSS)

Power system stabilizer is a generator control used in feedback to enhance the damping of rotor oscillation due to signal disturbance. The disturbance may be caused even by small changes in the reference voltage regulator exciter, resulting in ever increasing rotor oscillations. The generic PSS can be used to add damping to the rotor oscillation of the synchronous machine by controlling its excitation. To maintain stability, the power system's electromechanical oscillation (also called power swing) must be damped. The input signal of PSS is machine speed division ( $\Delta\omega$ ), and the output signal is additional input ( $V_{stab}$ ) to the excitation system [3]. The generic power system stabilizer is modeled by the nonlinear system shown in Fig. 1.

By controlling the excitation of the generator rotor oscillation using auxiliary stabilizing signal, PSS has become the most prevalent damping controller used in all synchronous generators, because of its low cost. PSS is used to this important function damp these oscillation by adding a signal

to the reference voltage signal, based on the automatic voltage regulator AVR; using power deviation, speed deviation, or frequency deviation with additional torque coaxial, PSS can increase the damping of low frequencies and developed the dynamic stability. Fig. 2 illustrates the torque analysis PSS and AVR.

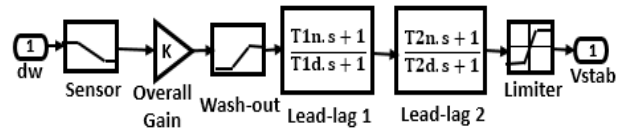

Fig. 1 Block diagram of the PSS

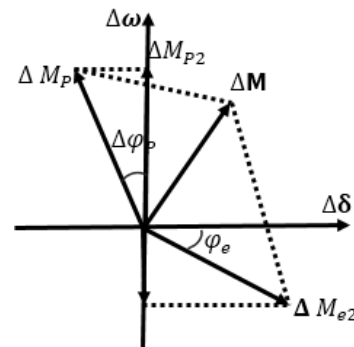

Fig. 2 Torque analysis between PSS and AVR [10]

The high gain of AVR will give a good voltage control and will increase the opportunities of retaining the synchronizing of the generator at the large disturbance, therefore this strife is almost solved by limiting the output of PSS to 0.5% set point of the AVR (Fig. 3). Solving tradeoff can be achieved more elaborately by applying the integration of PSS and AVR and using a design that takes damping and voltage control into account together [11]. The PSS uses a bus frequency or shaft speed active output power as input. The main components of stabilizer consist of two filters, used to phase lag compensation announced by the field circuit of generator and AVR. The other filter is often added to minimize the influence on the generator's dynamics torsional, and to stop voltage errors caused by frequency requital. The tuning of the lead lag filters will give a speed oscillation of damping torque on generator rotor. By making a difference in the terminal voltage, the effects of PSS to the flow of power from the generator, which effectively damps the local modes.

PSS has different effects on the inter-area mode from those it exerts on local mode; the realizable local mode is greater, while the inter-area mode is mainly influenced by the voltage modulation of responsive load. This has implications on the critical characteristics of load both for tuning the field and investigations. The damping of both inter area and local area mode needs an appropriate phase compensation over a great range, which is very difficult to realize. The speed signal  $\Delta\omega$  is used by PSS as an input signal, and it will have a positive compensation of damping torque  $\Delta M_{p2}$ . Therefore, torques of

composition and positive synchronicity can improve the capacity of oscillation damping [12].

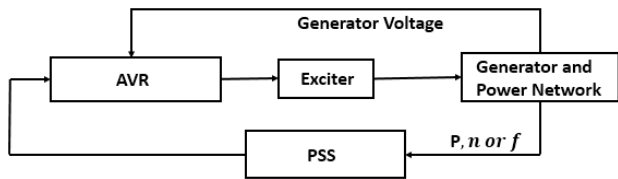

Fig. 3 Voltage control during large disturbance [10]

IV. STATIC VAR COMPENSATOR (SVC)

Static Var compensator is a member of FACTS family, which is based on power electronics. SVC is one of the shunt connected FACTS devices. An SVC consists of capacitors and reactors connected in shunt by a thyristor, by which switching can be quickly controlled. It is connected to the power system to improve transient stability by regulating voltage and reactive power control. By an injection or absorbing the amount of reactive power, the SVC regulates voltage. When the system voltage is low, the SVC generates reactive power (capacitive mode), and when the system voltage is high, the SVC absorbs reactive power (inductive mode).

A typical SVC, as shown in Fig. 4, consists of one or more banks of capacitors and reactors, which may be fixed or switched by thyristors. The reactive power can be varied by switching the capacitor banks and inductor banks. The capacitors are switched ON and OFF by thyristor switched capacitor (TSC), and the reactors are controlled by thyristor controlled reactors (TCR).

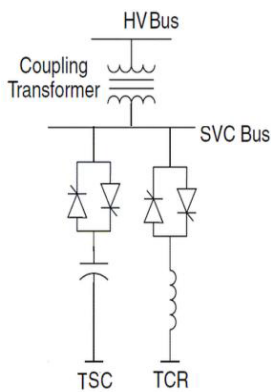

Fig. 4 Basic configuration of SVC

The SVC used in this study is of variable susceptance type. The relation between the compensator inductive susceptance  $B_L$  and the conduction angle  $\sigma$  for fundamental frequency is non-linear, given by:

$$B_L(\alpha) = 2\pi - 2\alpha - \sin 2\alpha / \pi X_s \quad \text{For } \pi/2 \leq \alpha \leq \pi \quad (1)$$

where:

$$X_s = V_s^2 / Q_L$$

where;  $V_s$  is SVC bus bar voltage;  $Q_L$  is the MVA rating reactor.

The total susceptance of SVC has the magnitude:

$$B = B_L - B_c$$

where BC is basing capacitor that allows the range of the compensator to enter both the capacitive and inductive region [13]. As the SVC uses an FC and a variable reactor combination (TCR-FC), the effective shunt admittance is given by:

$$B_s = [1/X_c] - B_L(\alpha) \quad (2)$$

where  $X_c$  is capacitive reactance.

The control system of SVC consists of a measurement of system, voltage regulator and synchronising system, as shown in Fig. 5. The measurement system measures the positive sequence voltage to be controlled. Fourier transformation is used for measurement system a voltage regulator that uses the voltage error. The SVC susceptance ( $B$ ) is determined by the difference between measured voltage ( $V_m$ ) and the reference voltage ( $V_{ref}$ ). The susceptance  $B$  is important to maintain constant system voltage. The TSC (and eventually the TCR) to be switched in and out is determined by distribution unit that computes the firing angle  $\alpha$  of TCR. A synchronizing system consists of a phase-locked loop (PLL) and a pulse generator sends an appropriate pulse to the thyristor [14].

Fig. 7 shows the SVC model for transient stability can be obtained by assuming balanced, fundamental frequency operation with sinusoidal voltages [15]. It can be represented by (3) and (4):

$$\begin{bmatrix} \dot{X}_c \\ \dot{\alpha} \end{bmatrix} = f_c(X_c, \alpha, V, V_{ref}) \quad (3)$$

$$0 = \begin{bmatrix} P - (2\alpha - \sin 2\alpha - \pi) - \pi[2(XL/XC)] / \pi XC \\ I - ViBe \\ I - Vi^2Be \end{bmatrix} \quad (4)$$

Most of the variables used in the (3) and (4) are clearly defined on Fig. 6, and the control system variables and equations are represented by  $x_c$  and  $f_c$ , respectively. These equations are used to represent limits not only on the firing angle, but also on the current ( $I$ ), the control voltage ( $V$ ) and the capacitor voltage ( $V_i$ ), as well as control variables for other types of controllers such as a reactive power  $Q$  control scheme [16].

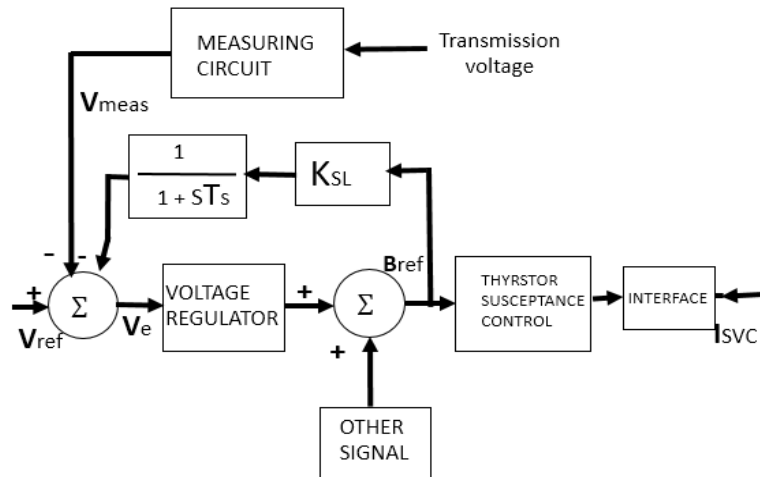

Fig. 5 Control system of SVC

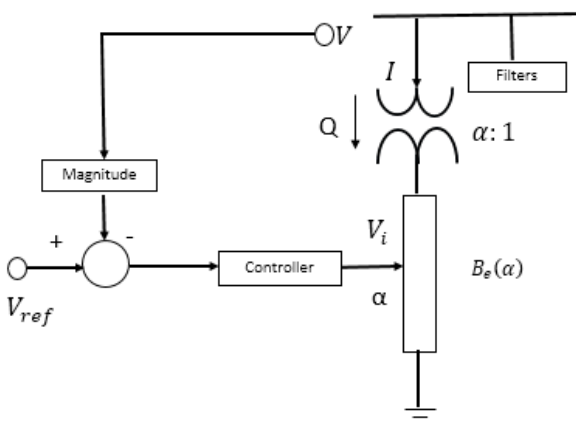

Fig. 6 Transient stability model of SVC

V. SIMULATION AND RESULTS

The comparison between PSS and SVC was conducted in a multi-machine system, as shown in Fig. 7. This system consists of 4 machines and 6 buses. The system was originally available in Matlab with two machines and three buses, but in order to consider more cases in this work, the number of machines and buses were increased. The disturbance applied is three phase fault to ground near a generator 1 on bus 1 at  $t=5s$ ; SVC is used as a controller is phaser type, connected to B1 and taking those cases:

A. Case 1

When comparing between using only PSS and PSS with SVC for a critical clearing time ( $t_c=148ms$ ), the results show that the system loses stability when utilizing PSS alone, while it remains stable using both SVC and PSS. Figs. 8-11 show the rotor angle difference of G1 of the test system, rotor angle difference of G3, the terminal voltage on B1 and transmission line active power of G1.

B. Case 2

Using PSS solely and PSS with SVC (to enhance transient

stability and dampen the oscillation), the system remained stable, at clearing time ( $t_c = 147ms$ ). Table I lists the performance comparison between using (PSS) and (PSS with SVC). Furthermore, Figs. 12 and 13 shows the rotor angle difference of G1 and rotor angle difference of G3; SVC settled faster with settling time is (11s and 10.3s) than with only PSS (13s and 12.3s), and the peak amplitude of both rotor angle with SVC reduced with value is 118 and 93 degrees, respectively. With only PSS, the corresponding values are 130 and 128 degrees. Figs. 14 and 15 show that the terminal voltage on B1 and B6 with SVC oscillated less and stabilized with peak amplitudes of 1.115 p.u and 1.18 p.u, and settling times of 10s and 10s, compared to only PSS with peak amplitudes of 1.275 p.u and 1.25 p.u and settling times of 12s and 12s. Figs. 16 and 17 show the transmission line active power values of G1 and G3; it can be seen that the line with SVC has less oscillation and greater stabilization that that with only PSS

C. Case 3

In this case the comparison between using PSS alone and two SVC with PSS in two different locations was made. The first SVC was connected to the system in a location the same as the previous one, and the second was connected near G3 with bus 6. The results show that using two SVCs is better than using only one; Table II lists comparison data between PSS and two SVC. Additionally, Figs. 18 and 19 show that rotor angle difference of G1 and rotor angle difference of G3 with SVC settled faster with settling time is (10s and 10s) than with only PSS (13s and 12.3s), and the peak amplitude of both rotor angle with SVC reduced with values of 115 and 85 degrees. With only PSS the settling time is 13 and 12.3s and the peak amplitude is 130 and 128 degrees. Figs. 20 and 21 show that the terminal voltage on B1 and terminal voltage on B6 with SVC oscillates less and stabilizes with peak amplitude (1.175p.u and 1.16p.u) and settling time (10s and 9s) compared to only PSS, where the peak amplitude is (1.275p.u and 1.25p.u) and settling time (12s and 12s). Figs. 22 and 23 show the transmission line active power of G1 and line power

of G3 with SVC oscillating less and stabilizing better than with only PSS.

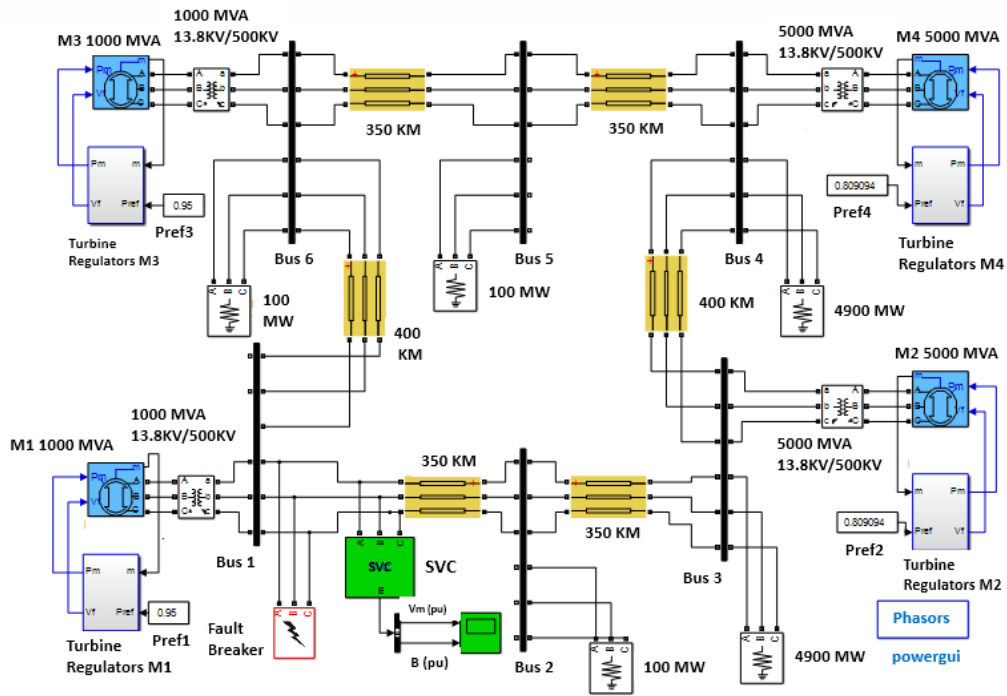

Fig.7 Test system (4 machine, 6 bus) modeled in Simulink/MATLAB

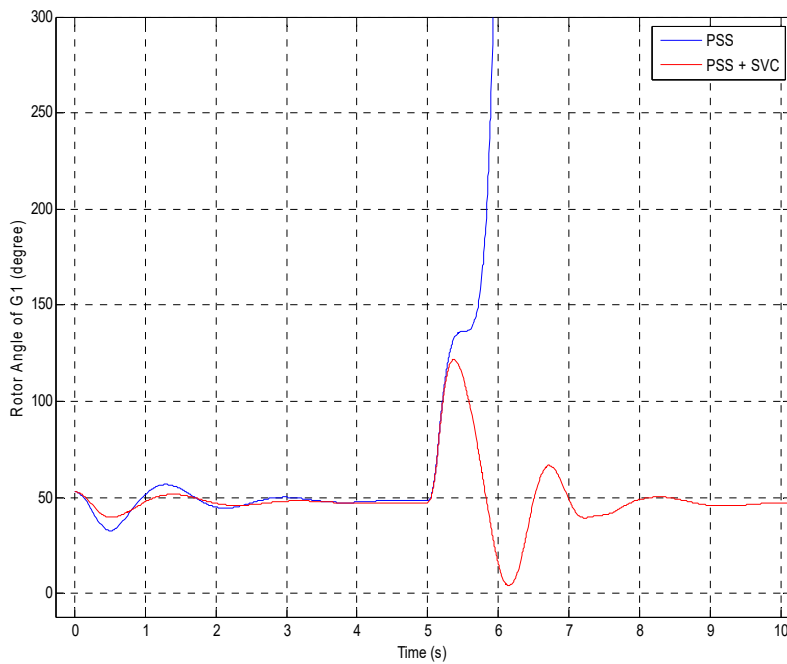

Fig. 8 Rotor angle difference of G1 to G2

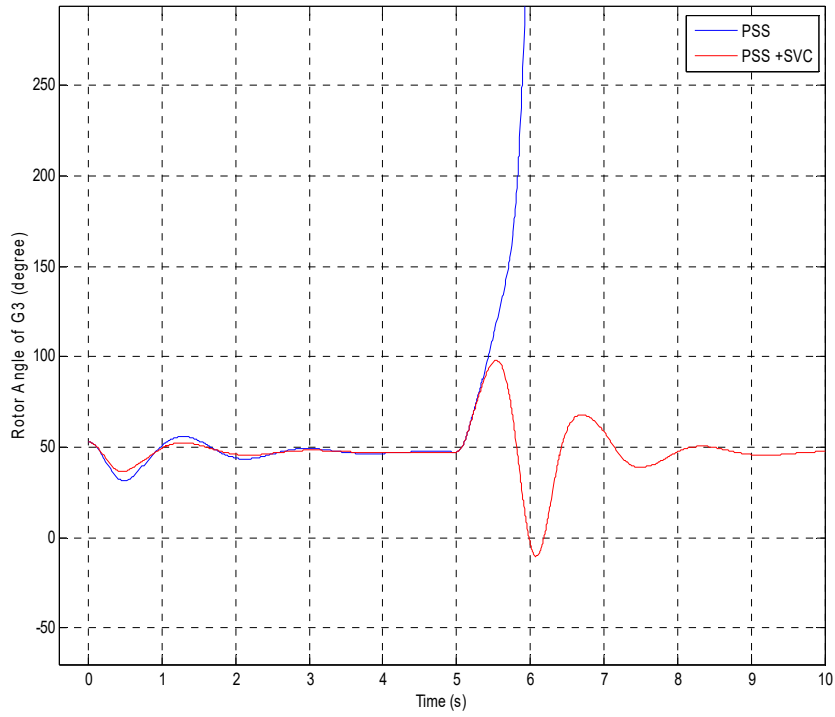

Fig. 9 Rotor angle difference of G3 to G4

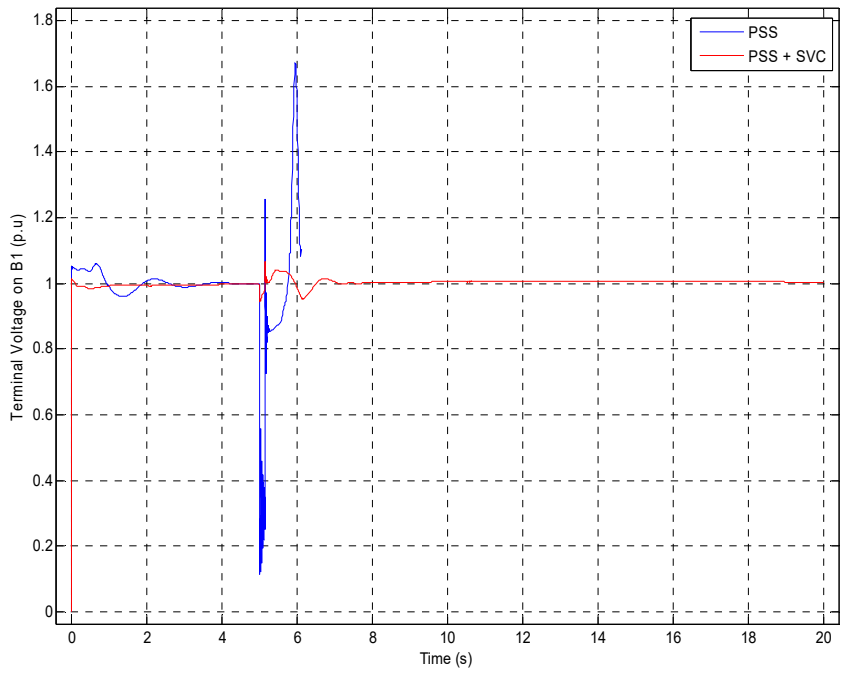

Fig. 10 Terminal voltage on B1

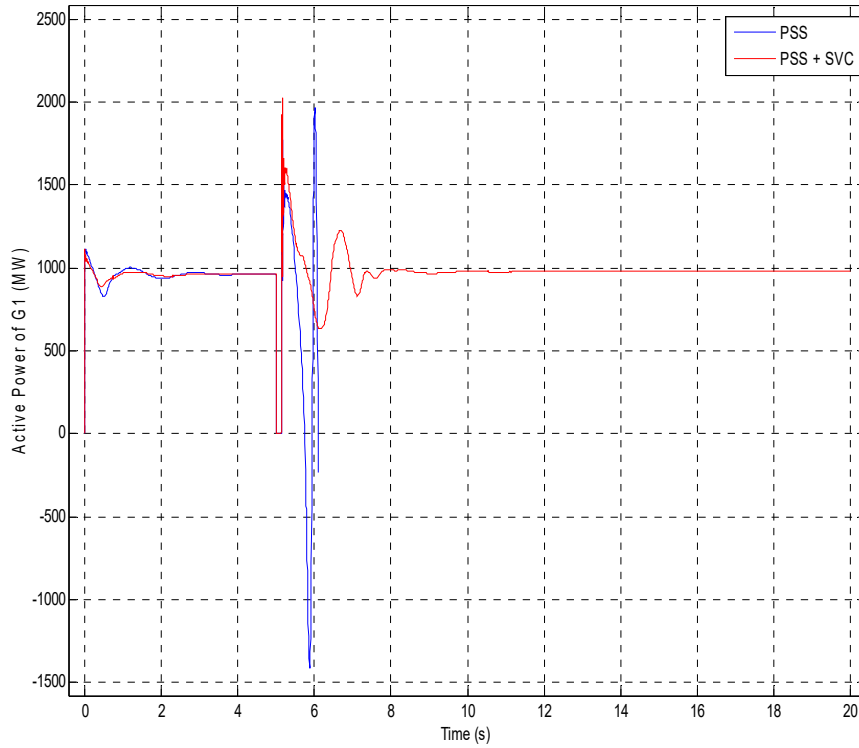

Fig. 11 Transmission line active power of G1

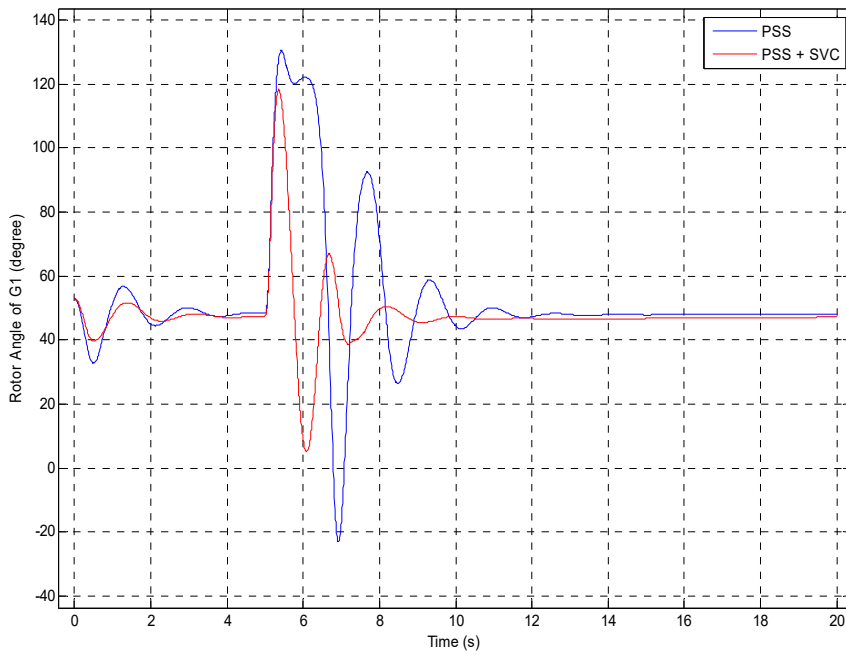

Fig. 12 Rotor angle difference of G1 to G2

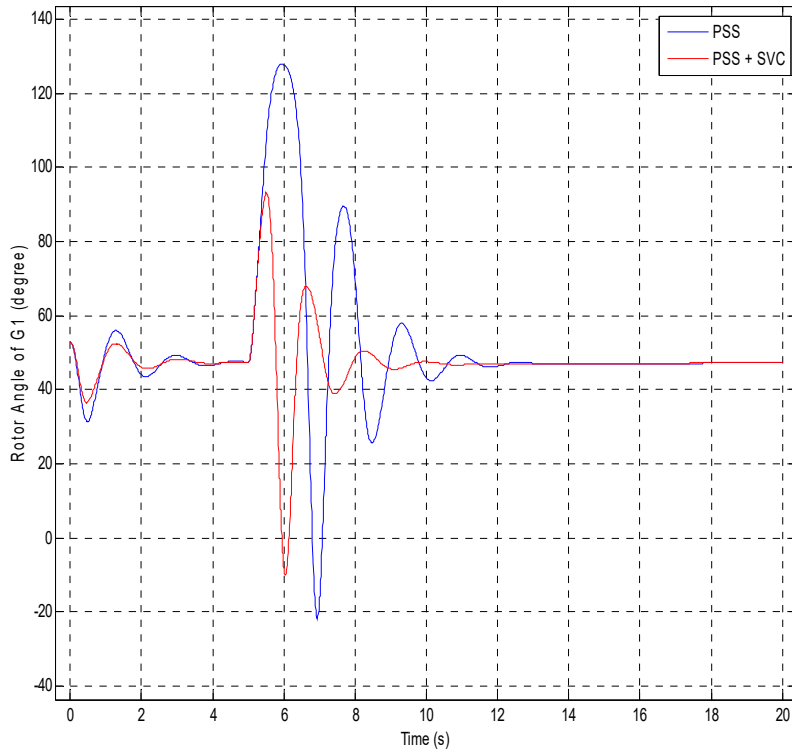

Fig. 13 Rotor angle difference of G3 to G4

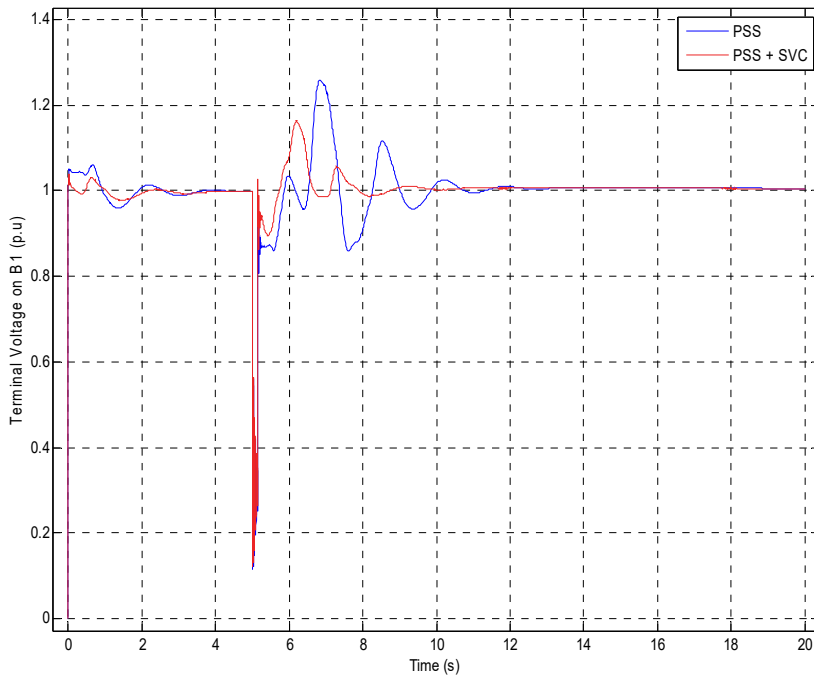

Fig. 14 Terminal voltage on B1



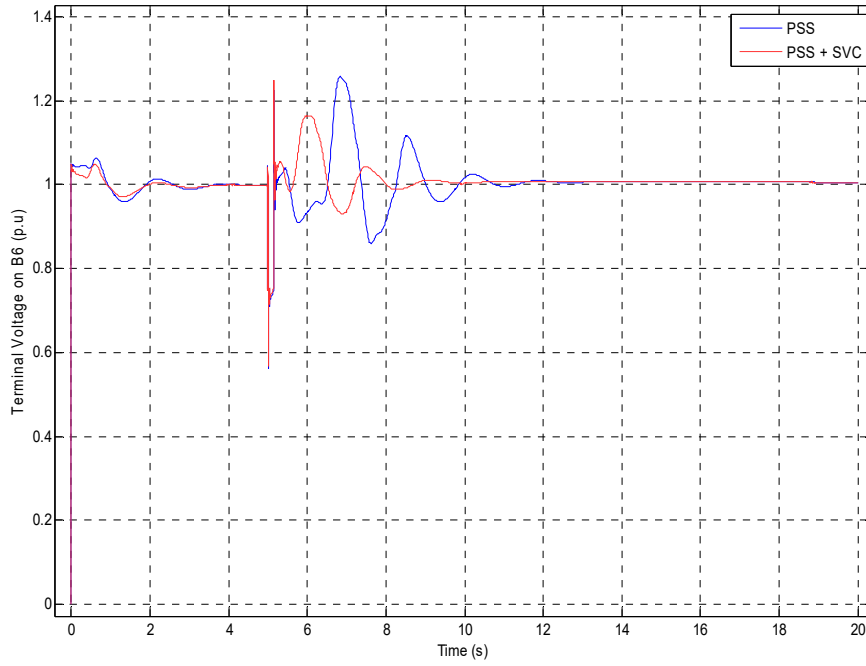

Fig. 15 Terminal voltage on B6

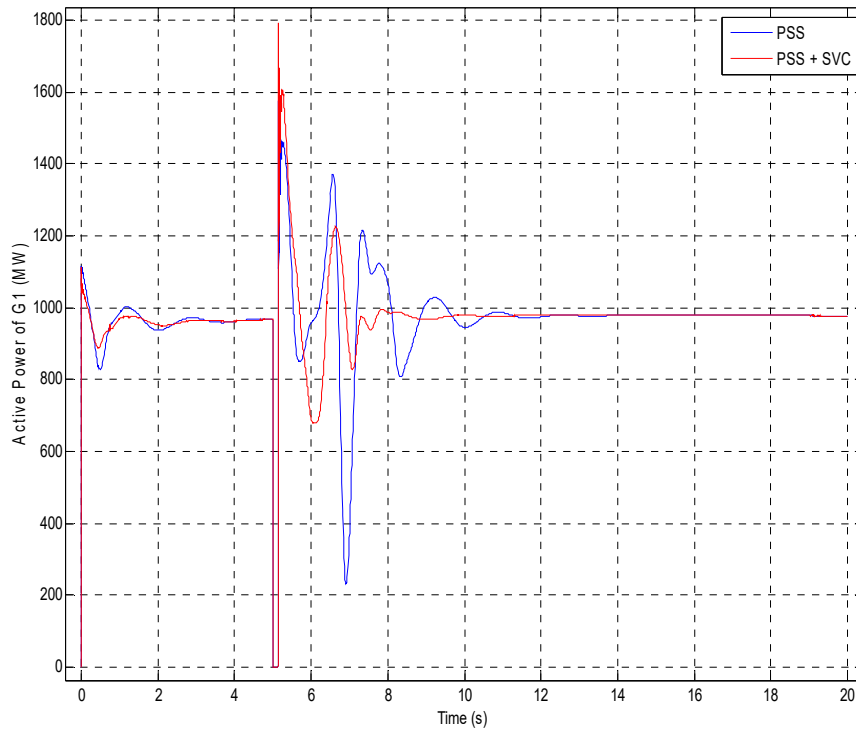

Fig. 16 Transmission line active power of G1

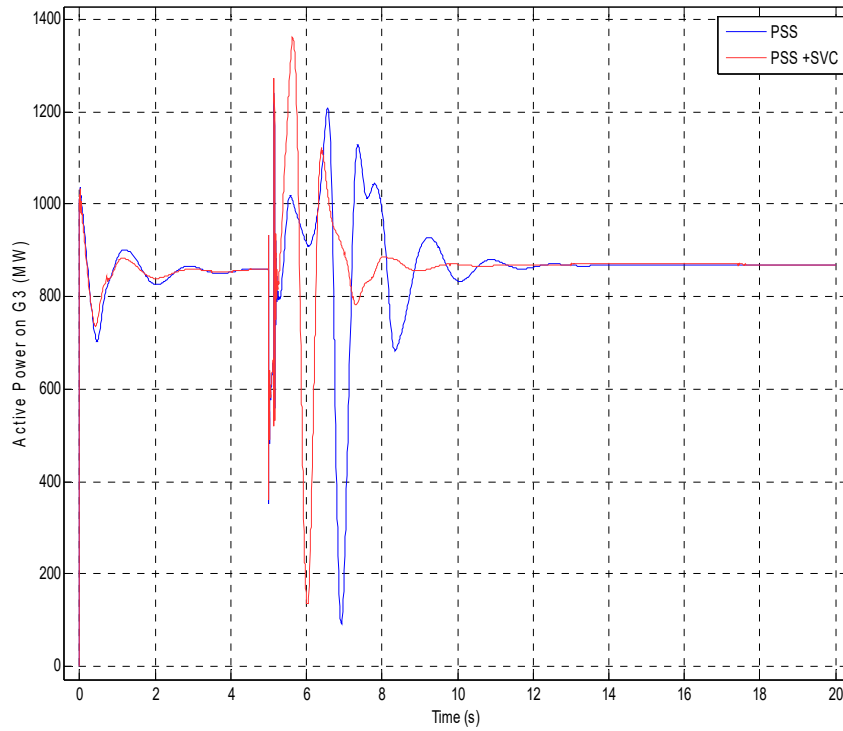

Fig. 17 Transmission line active power of G3

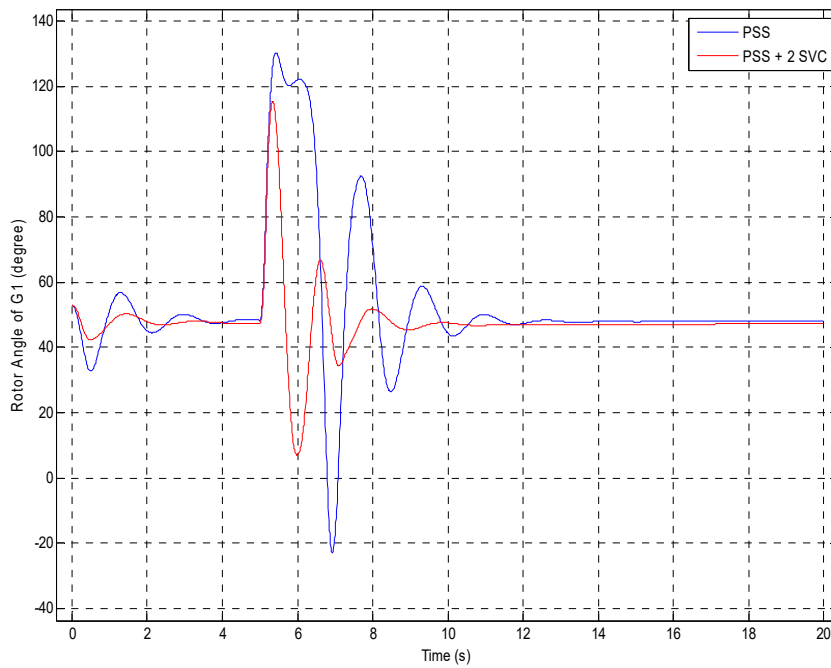

Fig. 18 Rotor angle difference of G1 to G2

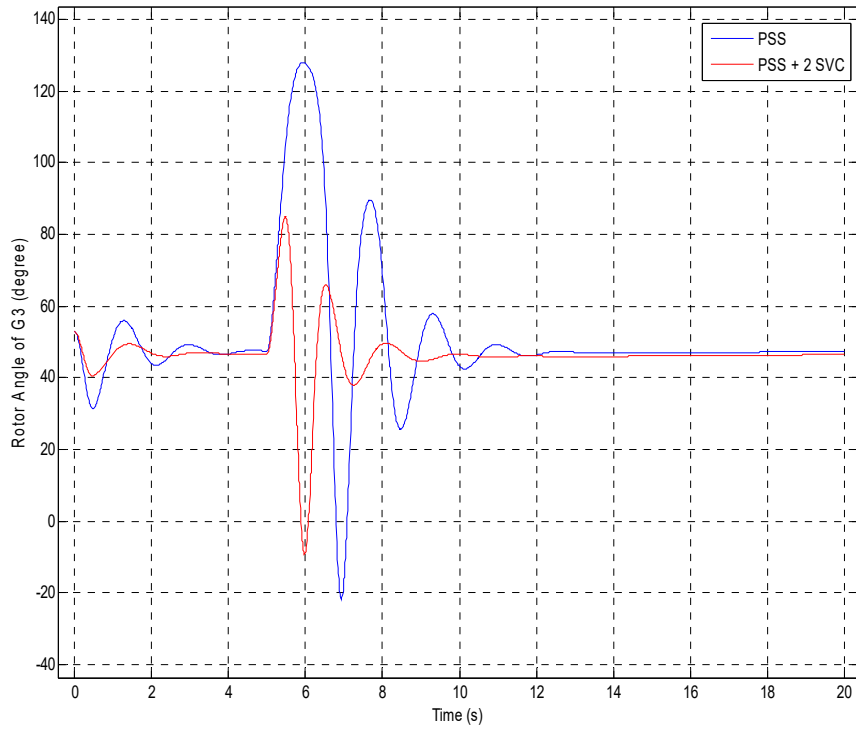

Fig. 19 Rotor angle difference of G3 to G4

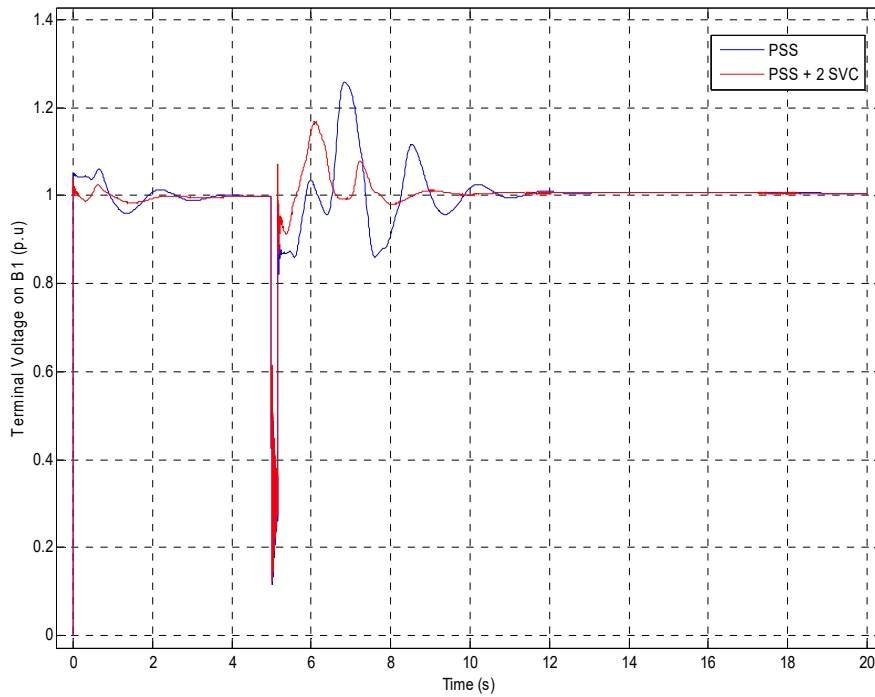

Fig. 20 Terminal voltage on B1

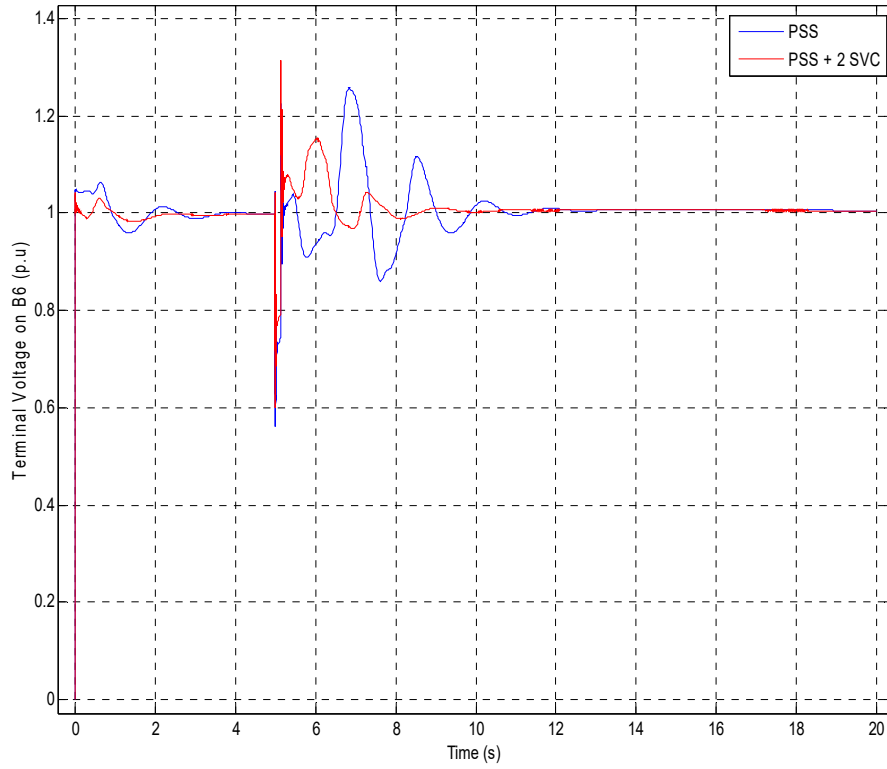

Fig. 21 Terminal voltage on B6

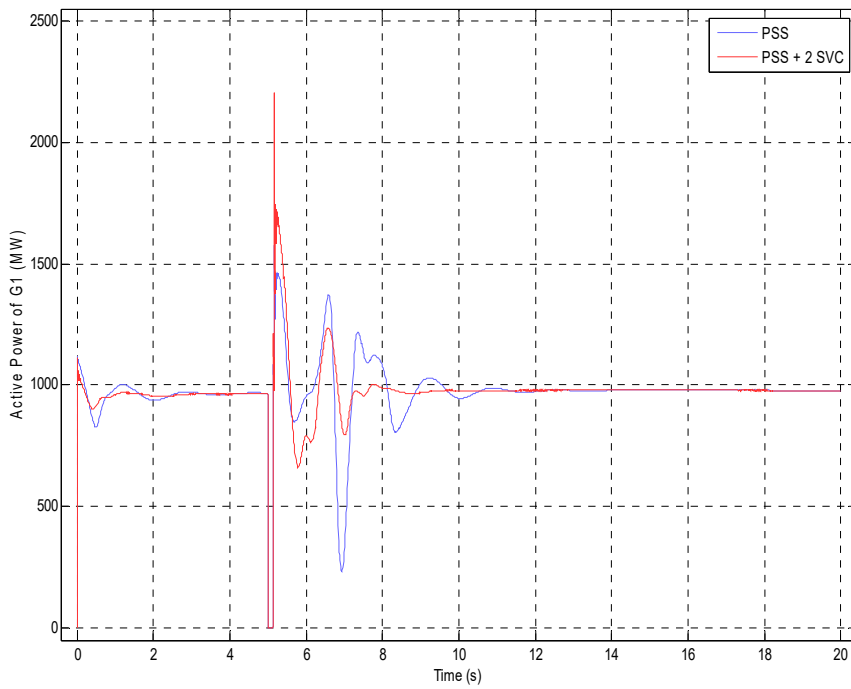

Fig. 22 Transmission line active power of G1

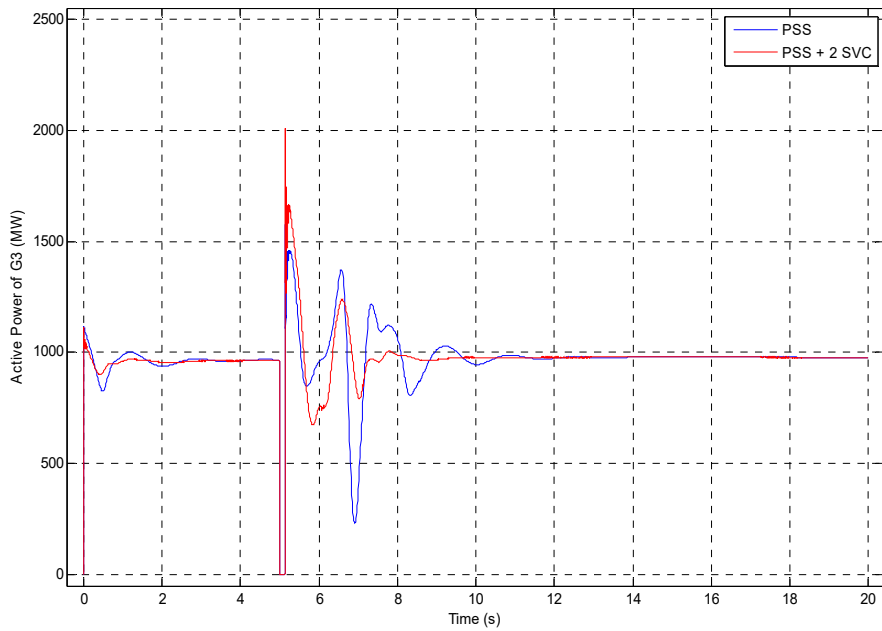

Fig. 23 Transmission line active power of G3

VI.CONCLUSION

This paper has discussed and investigated the transient stability enhancement by using a power system stabilizer PSS and static Var compensator. The study has compared the independent application of PSS and its combination with SVC using a multi-machine testing system consisting of four machines and six buses in MATLAB Simulink. During three phases to ground fault on generator 1 three cases were considered to identify the differences between PSS and SVC, and their ability to fix transient stability. Firstly, at the critical clearing time the system lost the synchronism when using PSS only, and it retained synchronism when SVC was connected with the system as a controller. In a second case with a clearing time of 147 ms, the system remained stable with both PSS only and PSS with SVC; however, the result was much better when utilizing SVC for damping oscillation. In the final case, two SVCs were used, and in comparison with previous cases the results indicated improved transient stability and damping oscillation of several parameters, such as rotor angle and terminal voltage and transmission lines active power.

TABLE I  
COMPARISON BETWEEN PSS AND PSS WITH SVC

Parameters	PSS		PSS + SVC	
	Peak	Ts (s)	Peak	Ts (s)
Rotor angle of G1	130 (deg.)	13	118 (deg.)	11
Rotor angle of G3	128 (deg.)	12.3	93 (deg.)	10.3
Terminal voltage on Bus 1	1.275 (p.u)	12	1.15 (p.u)	10
Terminal voltage on Bus 6	1.25 (p.u)	12	1.18 (p.u)	10
Active power of G1	1470 (MW)	12	1470 (MW)	10
Active power of G3	1470 (MW)	12	1350 (MW)	10

TABLE II  
COMPARISON BETWEEN PSS AND PSS WITH 2 SVC

Parameters	PSS		PSS + 2 SVC	
	Peak	Ts (s)	Peak	Ts (s)
Rotor angle of G1	130 (deg.)	13	115 (deg.)	10
Rotor angle of G3	128 (deg.)	12.3	85 (deg.)	10
Terminal voltage on Bus 1	1.275 (p.u)	12	1.175 (p.u)	10
Terminal voltage on Bus 6	1.25 (p.u)	12	1.16 (p.u)	9
Active power of G1	1470 (MW)	12	2000 (MW)	8.5
Active power of G3	1470 (MW)	12	1300 (MW)	10

APPENDIX

1. Transmission lines data

Vbase = 500 KV  
Resistance per unit length (Ohms/km) = 0.01755  
Inductance per unit length (H/km) = 0.8737e-3  
Capacitance per unit length (F/km) = 13.33e-9

2. Loads data

All loads are resistive load

Bus 2 = 100 MW  
Bus 3 = 4900 MW  
Bus 4 = 100 MW  
Bus 5 = 100 MW  
Bus 6 = 4900 MW

3. SVC data

Reactive power limits:  $[Q_c(\text{var}>0) Q_l(\text{var}<0)] = [200e6 -200e6]$   
Average time delay  $T_d = 0.004$  s

4. PSS data

Gain  $K_p = 2$   
Time constant = 0.7 s  
 $T_{num} = 0.06$  s  
 $T_{den} = 0.5$  s  
Sensor time constant = 15e-3 s

5. Generators Data

All generators data are shown in Table III.

TABLE III  
GENERATORS' DATA

Parameters	G1	G2	G3	G4
Gen types	Hydraulic	Hydraulic	Hydraulic	Hydraulic
Capacity (MVA)	1000	5000	1000	5000
X <sub>d</sub> (pu)	1.305	1.305	1.305	1.305
X' <sub>d</sub> (pu)	0.296	0.296	0.296	0.296
X'' <sub>d</sub> (pu)	0.252	0.252	0.252	0.252
X <sub>q</sub> (pu)	0.474	0.474	0.474	0.474
X'' <sub>q</sub> (pu)	0.243	0.243	0.243	0.243
X <sub>l</sub> (pu)	0.18	0.18	0.18	0.18
H (s)	3.7	3.7	3.7	3.7
T' <sub>d</sub> (s)	1.01	1.01	1.01	1.01
T'' <sub>d</sub> (s)	0.053	0.053	0.053	0.053
T''' <sub>qo</sub> (s)	0.1	0.1	0.1	0.1
R <sub>d</sub> (pu)	2.8544e-3	2.8544e-3	2.8544e-3	2.8544e-3

## REFERENCES

- [1] G. Hingorani and L. Gyugyi, "Understanding FACTS, Concepts, and Technology of Flexible AC Transmission Systems", Piscataway, NJ: IEEE Press, 2000.
- [2] A. A Edris, R Aapa, M H Baker, L Bohman, K Clark, "Proposed terms and definitions for flexible ac transmission system (FACTS)", IEEE Trans. on Power Delivery, Vol. 12, No. 4, 1997, pp. 1848-1853.
- [3] P. Kundur, Power System Stability and Control, New York: McGraw Hill, 1994.
- [4] Dash. P. K, Selta Morris and Mishra. S, "Design of a nonlinear Variable Controller for FACTS Devices", IEEE Transactions on Control System Technology, Vol. 12. No. 3, May 2004.
- [5] Patel, H. D, Majmudar, C, "Fuzzy logic application to single machine power system stabilizer," Power Nirma University International Conference on Engineering, IEEE, Vol. 2, pp. 669- 674, Dec 2011.
- [6] M. A. Abido, " Analysis and assessment of STATCOM based damping stabilizers for Power system stability enhancement" Electric Power System Research, 73, 177- 185, 2005
- [7] Mohan Mathur, Rajiv K. Varma , "Thyristor-Based Facts Controllers for Electrical Transmission Systems, John Wiley & Sons, Inc. Publication, 2002, pp 93-138.
- [8] B T Ooi, M Kazerrani, R Marcean, Z Wolanski, F D Galiana, D. Megillis, G. Joos, "Midpoint siting of FACTS devices in transmission lines", IEEE Tran. On Power Delivery, Vol. 1 No. 4, 1997, pp. 1717-1722.
- [9] S. M. Barakati, S. Khanmohamadi, S. H. Hosseini, "Improving the Power Stability using Fuzzy Logic Controlled Static Var Compensator", The 4th Iranian Conference on Electrical Engineering, ICEE-97, 1996.
- [10] Mitsubishi Electric. (2010). Power system stabilizer PSS
- [11] Samuelsson, O. (1997). Power system damping-structural aspects of controlling active power. Lund University.
- [12] Liu, F. , Yokoyama, R. , Zhou, Y. , & Wu, M. Study on Oscillation Damping Effects of Power System Stabilizer with Eigenvalue Analysis Method for the Stability of Power Systems.
- [13] E. Z. Zhou, "Application of Static Var Compensators to Increase Power System Damping, IEEE Transactions on Power Systems, Vol. 8, NO. 2, 1993.
- [14] M. H. Hague, "Improvement of first stability limit by utilizing full benefit of shunt FACTS devices, IEEE Transactions On Power Systems, vol. 19, no. 4, pp. 1894 – 1902, 2004.
- [15] Arunkumar, Priya G, "Power System Stability Enhancement using FACTS Controllers," IEEE, 2012.
- [16] Claudio A. canizares, "Power Flow and Transient Stability Models of FACTS Controllers for Voltage and angle Stability Studies, IEEE PES, 2000.



HAMA SALEH is a member of WASET and Engineers Union in Arbil-Iraq.

**Khoshnaw Khalid HAMA SALEH** got his B.Sc. from Electrical Engineering in Salahaddin University - Arbil, Iraq in 2005. He is a master student in Gaziantep University at Electric and Electronic Engineering department. His research interest includes power and distribution system. He has worked as an electrical engineer for five years in the governmental electrical sectors in Arbil. He also has experience in PLC and computerization of the plant factories and he has worked as a PLC engineer for four years. Mr.



**Ergun Ercelebi.** Received B.S. degree in Electrical and Electronics Engineering from METU, Gaziantep, Turkey in 1990 and M.S. and Ph.D. degrees in Electrical and Electronics Engineering from University of Gaziantep in 1992 and 1999 respectively. He was the head of Computer Engineering, University of Gaziantep between 2003 and 2004. He is presently Professor and head of dept of electrical electronics department, University of Gaziantep. His research interests include speech processing, image

processing, adaptive filters, neural networks, statistical signal processing wavelet.