

A Comparative Study on ANN, ANFIS and SVM Methods for Computing Resonant Frequency of A-Shaped Compact Microstrip Antennas

Ahmet Kayabasi, Ali Akdagli

Abstract—In this study, three robust predicting methods, namely artificial neural network (ANN), adaptive neuro fuzzy inference system (ANFIS) and support vector machine (SVM) were used for computing the resonant frequency of A-shaped compact microstrip antennas (ACMAs) operating at UHF band. Firstly, the resonant frequencies of 144 ACMAs with various dimensions and electrical parameters were simulated with the help of IE3D™ based on method of moment (MoM). The ANN, ANFIS and SVM models for computing the resonant frequency were then built by considering the simulation data. 124 simulated ACMAs were utilized for training and the remaining 20 ACMAs were used for testing the ANN, ANFIS and SVM models. The performance of the ANN, ANFIS and SVM models are compared in the training and test process. The average percentage errors (APE) regarding the computed resonant frequencies for training of the ANN, ANFIS and SVM were obtained as 0.457%, 0.399% and 0.600%, respectively. The constructed models were then tested and APE values as 0.601% for ANN, 0.744% for ANFIS and 0.623% for SVM were achieved. The results obtained here show that ANN, ANFIS and SVM methods can be successfully applied to compute the resonant frequency of ACMAs, since they are useful and versatile methods that yield accurate results.

Keywords—A-shaped compact microstrip antenna, Artificial Neural Network (ANN), adaptive Neuro-Fuzzy Inference System (ANFIS), Support Vector Machine (SVM).

I. INTRODUCTION

PRESENT portable communication and handheld devices inherently need miniaturized microstrip antennas (MAs). By using the substrate materials with high dielectric constant, the smaller antennas can be achieved but this gives rise to decrease the bandwidth and efficiency performances [1]. Thus, it is difficult to carry out the requirements of mobile communication devices by using the traditional MAs. The compact geometry has been proved as an alternate methodology to design miniature microstrip antennas. The compact microstrip antennas (CMAs) are obtained by applying some modification such as slot-loading and shorting-pin/wall on traditional MA structures [1]. Several slot loaded CMA configurations such as *C* [2]-[5], *E* [6]-[10], *H* [2], [3], [11]-[13], *L* [14], [15], annular ring [16]-[19] and rectangular ring [2], [20] shapes have been presented in the literature as an

alternative and effectively method to physically reduce the antenna size by increasing the effective resonant length. A-shaped CMA (ACMA) is also one of the configurations obtained by using the method of slots loading on the patch. It is observed that the ACMAs show similar features with *C*, *E*, *H*, *L*, annular ring and rectangular ring CMAs. The antenna designers can make selection among these designs according to the devices to be placed inside.

In analysis of the conventional MA, techniques such as cavity model [21] and transmission line model [22] are used. However, because of irregular shapes, CMAs may not be analyzed with use of these techniques. Simulation and experimental studies are therefore, carried out in analysis and design of CMAs, in general. Powerful simulation tools, which employ electromagnetic methods involving rigorous mathematical formulation and extensive numerical procedures such as finite difference time domain (FDTD) method [23] and method of moment (MoM) [24] are widely utilized; however, the design procedure may be highly time consuming using these tools. It is shown that the results of simulation tools are consistent with the experimental results in the literature [3]-[5], [8]-[10], [12], [13], [15], [17]-[20].

It is well known that current advancements in wireless communication technology have led to increase the use of CMAs; hence, simple models should be utilized to analyze their performances such as bandwidth and resonant frequency. On the other hand, the resonant frequency is of crucial importance in the CMA design process because these antennas inherently suffer from the narrow bandwidth. Alternative simple ways should therefore be investigated by taking into consideration that the analysis of the microstrip patch is a complex problem because of the fringing fields at the edges. There exist several approaches which vary in accuracy and computational efforts have been proposed to analyze and design CMAs. The most widely used can be listed as formulation methods [2]-[4], [9], [12], [17] and artificial intelligent systems (AIs) [5], [10], [13], [15], [18]-[20]. Formulation methods are commonly derived with the aid of the optimization algorithm such as genetic, particle swarm, differential evolution etc. The most well-known artificial intelligent systems are the artificial neural network (ANN) [25]-[27] and the adaptive neuro-fuzzy interference system (ANFIS) [28]-[30] and the support vector machine (SVM) [31], [32].

This paper deals with the computing the resonant frequency of the ACMAs operate in UHF band suitable for miniaturized

Ahmet Kayabasi is with the Department of Electronic & Automation, Silifke-Tasucu Vocational School, Selcuk University, 33900, Silifke, Mersin, Turkey (e-mail: ahmetkayabasi@selcuk.edu.tr).

Ali Akdagli is with the Department of Electrical & Electronics Engineering, Faculty of Engineering, Mersin University, 33343, Ciftlikkoy, Mersin, Turkey (email: akdagli@mersin.edu.tr).

mobile handsets, since that should take considerable attention in the design of any constructions of MA due to its having small bandwidth. In this work, a comparative study of ANN, ANFIS and SVM models for accurately computing the resonant frequencies of ACMA is presented. A distinct advantage of ANN, ANFIS and SVM, is that it bypass the repeated use of complex formulations or process for a new case given to it after proper training.

ANN attempt to model these poorly understood problems by employing a mathematical model of the brain's structure. The brain consists of billions of densely interconnected neurons. The premise behind ANN models is that mimicking the brain's structure of many highly connected processing elements will enable computers to tackle tasks they have not as of yet performed well. ANNs are mathematical models derived from this structure. Though biological plausibility is sometimes applied to ANN models, they are not intended to model the actual workings inside the brain or nervous system [25]. During the last decade, ANN models have been increasingly used in the design of antennas, microwave devices, and circuits due to their ability and adaptability to learn, generalization, smaller information requirement, fast real-time operation, and ease of implementation features. ANN models have been built for the design and analysis of microstrip antennas in various forms such as rectangular, circular, and equilateral triangle patch antennas.

The ANFIS is a powerful predicting or estimating method, which capable of producing the accurate results for a given problem, and it has the advantages of the learning property of ANNs and the expert knowledge of the fuzzy inference systems (FISs) [28]. The ANN attempts to model nonlinear problems by employing a mathematical model of the structure of the brain. The idea behind ANN models is that take an example by the brain's structure of many connected processing elements enables computers to tackle tasks. FISs are nonlinear systems capable of inferring complex nonlinear relationships between input and output variables. Linguistic expressions, which are the basis of the FIS, are optimized by the network and this provides ability of learning as well as data processing. Once the ANFIS model is properly trained according to the input data, the output can be accurately determined. While training process is completed in a few minutes, a new computation is done in a few seconds. The ability to associate both data and existing expert knowledge about the problems, accurate and fast learning, good generalization capability features have made neuro-fuzzy systems popular in the last decade.

Machine learning methods that proposed to analyze data and recognize patterns are used in two different methods that supervised (classification and regression) and unsupervised (clustering). In machine learning, SVM is a new generation supervised learning model which used for classification and regression analysis. In another terms, SVM is a classification and regression prediction tool that uses machine learning theory to maximize predictive accuracy while automatically avoiding over-fit to the data. The SVM is an advanced nonlinear learning machine (so-called Vapnik-Chervonenkis

theory) [31]. SVM is a machine learning method used for classification and regression implementations and also run supervised or semi-supervised way. In the nonlinear problems such as ours, SVM depends on the principle which is separation of two classes with a hyper plane that is occurred by transforming data to the higher dimensions. The functions that have various features are used during transform into the high dimension and these functions are called as Kernel functions. Some parameters in the mathematical expression of these functions need to be defined by the user for using Kernel functions. SVM has been formed on powerful theoretical foundations.

In this study, the dominant resonant frequencies of ACMA are accurately computed by using the new and effective applications of three methods mentioned above. To this end, the resonant frequency values of 144 ACMA operating among 0.96–3.21 GHz were determined by the commercial electromagnetic simulator IE3D™ using on MoM. In order to provide the generality and stability of the ANN, ANFIS and SVM networks, the parameters of 124 randomly selected ACMA were utilized to training the models and the 20 remainings were employed to test the accuracy of the models. The results obtained by using the proposed models have been compared with each other and the simulated results.

II. DESIGN AND SIMULATION OF ACMA

The geometry of the rectangular MA (RMA) and ACMA is given in Figs. 1 (a) and (b) respectively. The ACMA consists of an $L \times W$ rectangular patch given in Fig. 1 (b) with two identical slots in size of $l \times w$ on a dielectric substrate with h thickness on a metallic ground plane. The slots on the patch lead to an increase in the resonant length of the antenna; hence the patch size can be reduced.

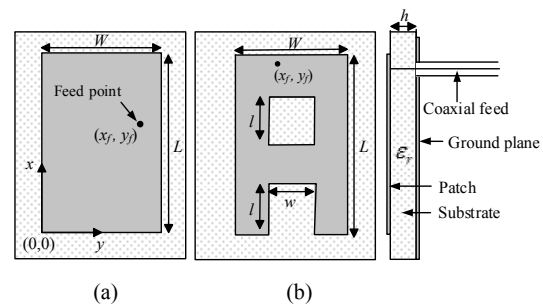

Fig. 1 Geometry of RMA (a), Geometry of ACMA (b)

Table I contains the simulation results of ACMA along with those of RMA having the same outer patch sizes. Feed points are used as shown Fig. 1 for ACMA and RMA at operating 2.4 GHz. The slots on the patch of the ACMA lead to a reduction in the resonant frequency of 23%, compared with the RMA having the same size, therefore the patch size of the ACMA is 41% smaller than that of the RMA at fixed 2.4 GHz. These comparative results obviously show that the CMA has superiority over the conventional MA in points of patch size for a given resonant frequency.

TABLE I
COMPARISONS FOR SIMULATED RESONANT FREQUENCIES AND BANDWIDTHS OF RMA AND ACMA

Antenna	Patch Dimensions (mm)					ϵ_r	Resonant frequencies (GHz)	Bandwidth [MHz]
	L	W	l	w	h			
ACMA	30.00	25.00	12	3	1.57	2.33	2.400	12.5
RMA	39.85	32.35	—	—	1.57	2.33	2.400	10
RMA	30.00	25.00	—	—	1.57	2.33	3.180	50

Table I also shows that a narrow-band ACMA with smaller size is achievable, while wider band can be obtained at the cost of the bigger size than that of a RMA operating at the same resonant frequency. This provides that the designer can make a trade-off between the smallness and wideband properties.

The ACMA is a novel design hence; some analysis results hereby are presented. The simulated surface current distributions of the antenna at the frequency of 2.4 GHz is shown in Fig. 2. From Fig. 2, the current is mostly concentrated upper and lower sides of the slots. Especially, the current crosses at the edge to the slots. Therefore, the radiation is effectively taken place between these edges and the ground plane. On the other hand, the simulated radiation patterns operating at 2.4 GHz for x - z plane ($\phi = 0^\circ$) and y - z plane ($\phi = 90^\circ$) are given in Fig. 3 (a). It is seen that the radiation patterns have good performance and approach omni-directional radiation characteristic. The simulated gain plot of that antenna is given in Fig. 4. The peak gain 4.30 dBi occurs about the frequency of 2.4 GHz with the radiation efficiency exceeding 75% as is expected.

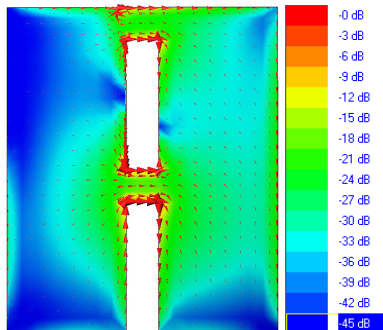

Fig. 2 Simulated surface current distribution at 2.4 GHz

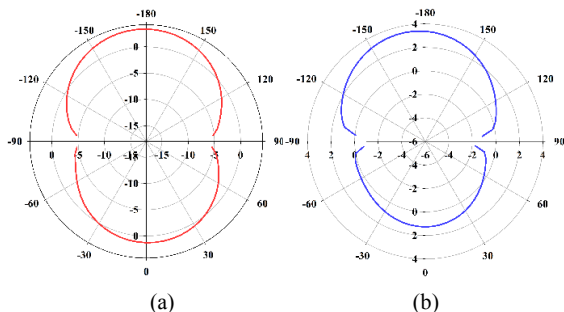

Fig. 3 The simulated radiation pattern at 2.4 GHz: (a) in x - z plane and (b) in y - z plane

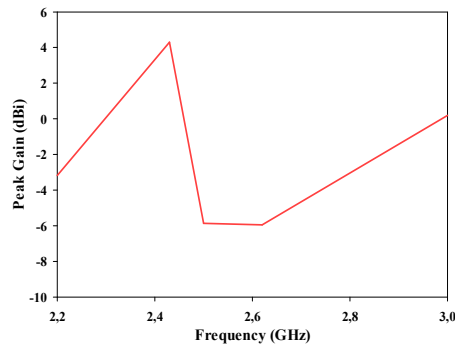

Fig. 4 The simulated gain graph

The topology of the simulation process is illustrated in Fig. 5. It is seen that the parameters groups given in Table II, which include the various dimensions and the electrical parameters of the ACMAs, are used to generate resonant frequency values with the aid of IE3D™ software. In the simulations, maximum frequency and cell/wavelength rate were assumed as 4 GHz and 40, respectively. A 50 ohm probe feed was applied. Optimization module in IE3D™ based on genetic algorithm was utilized to define the feed point for $|S_{11}| < -10$ dB objective function, resulting in the best return loss value.

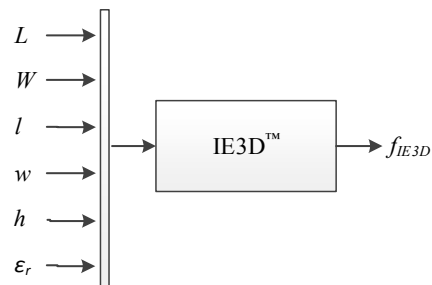

Fig. 5 Simulation process of ACMAs

TABLE II
DIMENSIONS AND DIELECTRIC CONSTANTS OF SIMULATED ACMAS

Number of simulations	Antenna dimensions (mm)					
	L	W	l	w	h	ϵ_r
30	25	3, 6, 9, 12	3, 6, 9, 12	1.57	2.33, 4.5, 6.15	
40	30	4, 8, 12, 16	4, 8, 12, 16	2.5	2.33, 4.5, 6.15	
50	35	5, 10, 15, 20	5, 10, 15, 20	3.17	2.33, 4.5, 6.15	

III. COMPUTATION THE RESONANT FREQUENCY OF ACMA WITH ANN, ANFIS, AND SVM MODELS

A. Training Process of the ANN, ANFIS, and SVM Models

The topology of the training process and computation of the average percentage error (APE) are illustrated for ANN, ANFIS and SVM in Fig. 6. The ANN, ANFIS and SVM models were trained as the parameters of 124 simulated antennas together with the corresponding resonant frequencies were introduced as the inputs. It should be noted that the antennas to be used in training process was randomly selected from whole simulations in order to represent the entire

solution space.

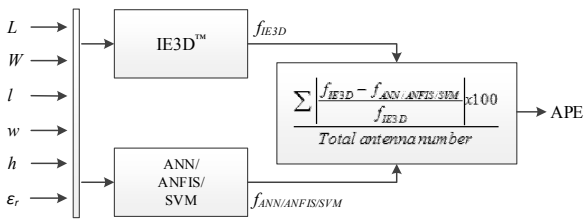

Fig. 6 The topology of the calculating APE for ANN, ANFIS and SVM models

A block diagram for running of the ANN model is given in Fig. 7. The ANN model based on multilayer perceptron (MLP) consisting of 1 hidden layer with 3 neurons was constructed in this work. “Tangent sigmoid” function was used for input and hidden layers while “purelin” function was utilized for output layer. The Levenberg-Marquardt (LM) algorithm was used in the ANN model as training algorithm, since it is capable of fast learning and good convergence. The parameters of the ANN model used in this work are tabulated in Table III. According to (1), the value of the average percentage errors (APE) for the resonant frequencies computed by the ANN model was obtained as 0.457% for the 124 ACMA’s training data.

$$APE = \frac{\sum \left| \frac{f_{IE3D} - f_{ANN/ANFIS/SVM}}{f_{IE3D}} \right| \times 100}{Total\ antenna\ number}$$

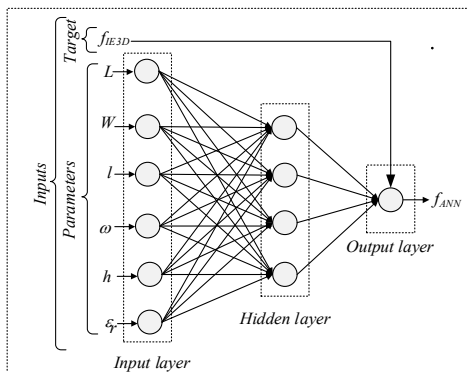

Fig. 7 Block diagram of the ANN model

TABLE III
THE ANN PARAMETERS

Parameters	Value
Number of input	6
Number of output	1
Epochs	300
Seed value	1249359025
Minimum gradient descent	10 ⁻¹⁰
Momentum parameter (μ)	0.0001
μ increment	4
μ decrement	0.1
Maximum μ	10 ¹⁰

A block diagram for the running of the ANFIS model that uses Sugeno type FIS built is given in Fig. 8. In the training process for ANFIS, Gaussian function for the inputs and linear function for the output were chosen as membership functions (MFs). For the ANFIS network, the hybrid-learning algorithm was used. The hybrid-learning algorithm that constabates the backpropagation algorithm (BP) and the least-square method (LSM) is utilized to assign the parameters of ANFIS. The parameters of the ANFIS model used in this work are tabulated in Table IV. ANN defines the membership degrees of the input/output variables of the FIS in ANFIS architecture. It does this process by training FIS structure with an ANN algorithm. In the every run process of ANFIS model, results can be different in each run because initial weights of ANN are used randomly. The seed value should be fixed to get same result in every run. For this purpose the seed in the run which is error obtained under desired value is saved. Initial weights of ANN are fixed by replacing the saved seed value in the program. This method takes time during finding the proper seed value, but after getting the proper seed value, it gives results in a few seconds. The results of ANFIS model are in very good harmony with those of the simulations and APE was computed as 0.399% for the training data.

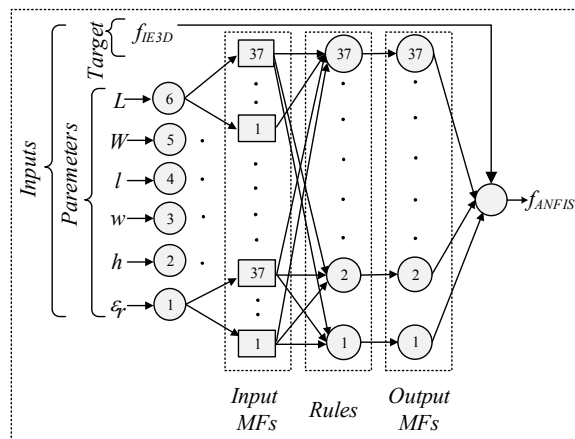

Fig. 8 Block diagram of the ANFIS model

TABLE IV
THE ANFIS PARAMETERS

Parameters	Set type/value
Input MF type	Gaussian
Output MF type	Linear
Number of input	6
Number of output	1
Number of fuzzy rules	37
Number of MFs	37
Seed value	1979332410
Epochs	50
Range of influence	0.5
Squash factor	1.25
Accept ratio	0.5
Reject ratio	0.15
Number of nonlinear parameters	6 x 37 x 2 = 444
Number of linear parameters	7 x 37 = 259
Number of nodes	527
Number of training data pairs	130

In addition ANN and ANFIS also SVM model was used for computing the resonant frequency of ACMAs and the block diagram of SVM model is shown in Fig. 9. The parameters of the SVM model used in this work are tabulated in Table V. The APE for the resonant frequencies computed by the model was obtained as 0.600% for the 124 ACMAs' training data. The gaussian kernel function was used in SVM. The used gaussian kernel function is given as in (2).

$$k(x, y) = \exp\left(-\frac{\|x - y\|^2}{2\sigma^2}\right) \quad (2)$$

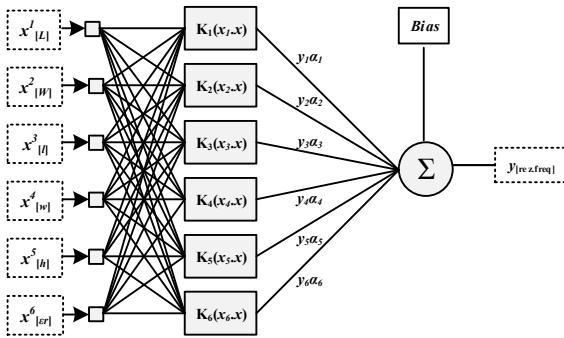

Fig. 9 Block diagram of the SVM model

TABLE V
THE SVM PARAMETERS

Parameters	Set type/value
Kernel function	Gaussian
Kernel function coefficient (σ)	28
Penalty weight (C)	1000000
Slack variables (epsilon- ξ)	0.001
Number of input	6
Number of output	1

As it was seen from the Fig. 10, the results of ANN, ANFIS and SVM models are in very good agreement with those of the simulations. The best performance was achieved by ANFIS, however, it should be noted that ANN and SVM models also were obtained remarkable results in the training process.

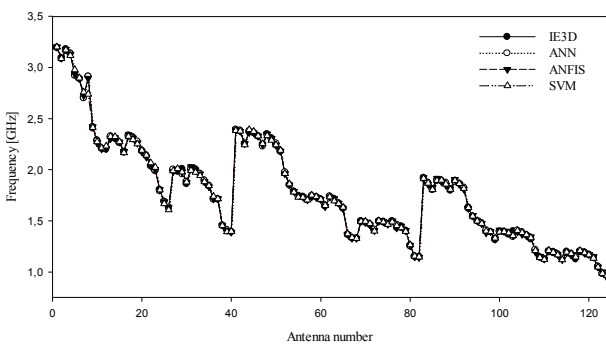

Fig. 10 Comparative results of the simulation, ANN, ANFIS and SVM

B. Test Process of the ANN, ANFIS and SVM Models

To verify the ANN, ANFIS and SVM models, 20 simulated ACMAs, which were randomly selected from a total of 144 antennas before the training process so as to represent the solution space, were used in the test process. Electrical and psychical parameters of 20 selected ACMAs listed in Table VI. The simulated and computed resonant frequency values, and calculated APEs are given in Table VII. APEs were obtained respectively as 0.601%, 0.744% and 0.623% for the ANN, ANFIS and SVM over 20 ACMAs.

TABLE VI
ELECTRICAL AND PSYCHICAL PARAMETERS OF 14 SIMULATED ACMAS FOR TEST PROCESS

ACMAs	Patch dimensions (mm)					
	L	W	l	w	h	ϵ_r
1	30	25	3	6	1.57	2.33
2	30	25	3	12	1.57	2.33
3	30	25	6	9	1.57	2.33
4	30	25	9	6	1.57	2.33
5	30	25	9	12	1.57	4.5
6	30	25	12	12	1.57	4.5
7	30	25	9	6	1.57	6.15
8	30	25	12	3	1.57	6.15
9	40	30	4	12	2.5	2.33
10	40	30	16	12	2.5	2.33
11	40	30	4	16	2.5	4.5
12	40	30	16	4	2.5	4.5
13	40	30	8	16	2.5	6.15
14	40	30	16	8	2.5	6.15
15	50	35	5	10	3.17	2.33
16	50	35	15	20	3.17	2.33
17	50	35	5	15	3.17	4.5
18	50	35	20	15	3.17	4.5
19	50	35	10	5	3.17	6.15
20	50	35	20	15	3.17	6.15

TABLE VII
THE RESONANT FREQUENCIES AND APE VALUES FOR TESTING PROCESS

ACMA	Resonant frequencies (GHz)				Percentage Errors (%)		
	Simulated	ANN	ANFIS	SVM	ANN	ANFIS	SVM
1	3.182	3.161	3.205	3.169	0.648	0.716	0.418
2	2.955	2.963	2.949	2.957	0.281	0.176	0.069
3	3.070	3.081	3.066	3.053	0.347	0.132	0.555
4	2.744	2.767	2.724	2.813	0.838	0.744	2.488
5	2.004	2.044	1.992	2.006	2.041	0.574	0.133
6	1.609	1.612	1.615	1.621	0.158	0.338	0.733
7	1.751	1.751	1.739	1.778	0.005	0.703	1.498
8	1.557	1.544	1.576	1.583	0.823	1.213	1.676
9	2.345	2.338	2.376	2.334	0.312	1.339	0.483
10	1.809	1.766	1.801	1.806	2.361	0.448	0.189
11	1.641	1.642	1.624	1.631	0.056	1.010	0.615
12	1.457	1.457	1.457	1.461	0.034	0.001	0.294
13	1.412	1.423	1.430	1.404	0.789	1.278	0.511
14	1.180	1.164	1.192	1.181	1.355	0.992	0.092
15	1.907	1.903	1.892	1.910	0.214	0.796	0.138
16	1.769	1.778	1.764	1.760	0.490	0.301	0.472
17	1.367	1.371	1.369	1.369	0.271	0.168	0.145
18	1.114	1.117	1.133	1.119	0.228	1.682	0.455
19	1.200	1.193	1.208	1.195	0.579	0.662	0.411
20	0.958	0.957	0.974	0.969	0.188	1.607	1.085
APE					0.601	0.744	0.623

As it seen, the resonant frequency results computed by our models are much closer to the simulated ones. The results that are close to each other shows that these models can be used successfully for computing the resonant frequency of ACMAs. These models provide the more accurate and relatively simple way since they require neither sophisticated functions of mathematical transformations nor rigorous expertness to determine the unknown parameters in any problem including highly nonlinearity. The training process is once completed in a few minutes by properly choosing the network parameters; one can easily compute any parameters of interest in microseconds.

IV. CONCLUSION

In this paper, applications of ANN, ANFIS and SVM models are successfully implemented for the computation of resonant frequency of ACMAs. IE3D™ simulation software based on MoM was used to define resonant frequency of 144 ACMAs. The physically and electrical parameters of 124 ACMAs were utilized for training the ANN, ANFIS and SVM models, 20 ACMAs were also utilized for the test. It was seen that computed results with ANN, ANFIS and SVM for training and test data are in a good agreement with the simulation results. Among the three methods, the best performance was obtained by ANFIS model for training process, but ANN model yields the better results than those of the ANFIS and SVM in the test process. The ANN, ANFIS and SVM approaches are simple and fast modeling which produces more accurate results for the resonant frequency of the ACMAs with less computational time and least errors. The most important advantages of these models are accuracy and easy to implement for the engineering problems which include the high nonlinearity.

ACKNOWLEDGMENT

This research was supported by Selcuk University, Scientific Research Projects (SÜ-BAP-2015/15701398 Konya/Turkey).

REFERENCES

- [1] K. L. Wong, "Compact and broadband microstrip antennas," Wiley, Interscience, 2002.
- [2] A. A. Deshmukh and G. Kumar, "Formulation of resonant frequency for compact rectangular microstrip antennas," *Microw Opt Techn Lett*, vol. 49 no. 2, pp. 498 – 501, 2007.
- [3] A. Toktas, A. Akdagli, M.B. Bicer and A. Kayabasi, "Simple formulas for calculating resonant frequencies of C and H shaped compact microstrip antennas obtained by using artificial bee colony algorithm," *Journal of Electromagnetic Waves and Applications*, vol. 25, pp. 1718-1729, 2011.
- [4] A. Akdagli, M.B. Bicer and S. Ermis, "A novel expression for resonant length obtained by using artificial bee colony algorithm in calculating resonant frequency of C-shaped compact microstrip antennas," *Turkish Journal of Electrical Engineering and Computer Sciences*, vol. 19, pp. 597-606, 2011.
- [5] A. Akdagli, A. Kayabasi and İ. Develi, "Computing Resonant Frequency of C-Shaped Compact Microstrip Antennas by Using ANFIS," *International Journal of Electronics*, vol. 102, no. 3, pp. 407-417, 2015.
- [6] B. L. Ooi and Q. Shen, "A novel E-shaped broadband microstrip patch antenna," *Microwave Opt TechnolLett*, vol. 27, no. 5, pp. 348-352, 2000.
- [7] A. A. Deshmukh and G. Kumar, "Compact broadband E-shaped microstrip antennas," *Electronics Letters*, vol. 41, no. 18, 2005.
- [8] A. Khidre, K. F. Lee, F. Yang and A. Elsherbeni, "Wideband Circularly Polarized E-shaped Patch Antenna for Wireless Application," *IEEE Trans Antennas Propagat*, vol. 52 no. 5, pp. 219-229, 2010.
- [9] A. Toktas and A. Akdagli, "Computation of resonant frequency of E-shaped compact microstrip antennas," *Journal of the Faculty of Engineering and Architecture of Gazi University*, vol. 27, pp. 847-854, 2012.
- [10] A. Akdagli, A. Toktas, A. Kayabasi and İ. Develi, "An Application of Artificial Neural Network to Compute the Resonant Frequency of E-Shaped Compact Microstrip Antennas," *Journal of Electrical Engineering- Elektrotechnicky Casopis*, vol. 64, no. 5, pp. 317-322, September 2013.
- [11] A.F. Sheta, A. Mohra, and S.F. Mahmoud, "Multi-band operation of a compact H-shaped microstrip antenna," *Microw Opt Techn*, vol. 35, pp. 363-367, 2002.
- [12] A. Akdagli and A. Toktas, "A novel expression in calculating resonant frequency of H-shaped compact microstrip antennas obtained by using artificial bee colony algorithm," *J Electromagnet Wave*, vol. 24, no. 14-15, pp. 2049-4061, 2010.
- [13] A. Kayabasi, M. B. Bicer, A. Akdagli and A. Toktas, "Computing Resonant Frequency of H-Shaped Compact Microstrip Antennas Operating at UHF Band by Using Artificial Neural Networks," *Journal of the Faculty of Engineering and Architecture of Gazi University*, vol. 26, no. 4, pp. 833-840, December 2011.
- [14] Z. N. Chen, "Radiation pattern of a probe fed L-shaped plate antenna," *Microw OptTechnLett*, vol. 27, pp. 410-413, 2000.
- [15] A. Kayabasi, A. Toktas, A. Akdagli, M. B. Bicer and D. Ustun, "Applications of ANN and ANFIS to Predict the Resonant Frequency of L-shaped Compact Microstrip Antennas," *Applied Computational Electromagnetic Society Journal - ACES*, vol. 29, no. 6, pp. 460-469, June 2014.
- [16] W. Chew, "A broad-band annular-ring microstrip antenna," *Antennas and Propagation, IEEE Transactions on*, vol. 30, no. 5, pp. 918-922, 1982.
- [17] A. Toktas, A. Akdagli, A. Kayabasi, D. Ustun and M. B. Bicer, "A Simple and Accurate Expression for Resonant Frequency Calculation of Annular-Ring Microstrip Antennas," *International Journal of Microwave and Wireless Technologies*, 1-7, 2014. DOI: 0.1017/S1759078714000890.
- [18] A. Akdagli and A. Kayabasi, "An Accurate Computation Method Based on Artificial Neural Networks with Different Learning Algorithms for Resonant Frequency of Annular Ring Microstrip Antennas," *Journal of Computational Electronics*, vol. 13, pp. 1014-1019, 2014.
- [19] A. Kayabasi and A. Akdagli, "A Novel Method of Support Vector Machine to Compute the Resonant Frequency of Annular Ring Compact Microstrip Antennas," *Cogent Engineering*, vol. 2, no. 1, 6 January 2015.
- [20] A. Akdagli, A. Toktas, M. B. Bicer, A. Kayabasi, D. Ustun and K. Kurt, "ANFIS Model for Determining Resonant Frequency of Rectangular Ring Compact Microstrip Antennas," *International Journal of Applied Electromagnetics Mechanics*, vol. 46, no. 3, pp. 483-490, 27 February 2014.
- [21] W. F. Richards, Y.T. Lo and D. D. Harrisson, "An improved theory for microstrip antennas and applications," *IEEE T. Antenn. Propag.* vol. 29, pp. 38-46, 1981.
- [22] K. Bhattacharyya and R. Garg, "A generalized transmission line model for microstrip patches," *IEE Proc. Microwave Antennas Propag.* vol. 132, pp. 93-98, 1985.
- [23] A. Taflove, "Computational electrodynamics: The finite-difference time domain method," Boston, Artech House, 1995.
- [24] R. F. Harrington, "Field computation by moment methods," Piscataway, NJ, IEEE Press, 1993.
- [25] S. Haykin, "Neural networks: A comprehensive foundation," Macmillan College Publishing Company, New York, A.B.D., 1994.
- [26] C. G. Christodoulou and M. Georgiopoulos, "Application of Neural Networks in Electromagnetics," Artech House, MA, USA, 2001.
- [27] K. Guneay, and S. S. Gultekin, "Artificial neural networks for resonant frequency calculation of rectangular microstrip antennas with thin and thick substrates," *International Journal of Infrared and Millimeter Waves*, vol. 25, no. 9, 2004.
- [28] J. S. R. Jang, "ANFIS: Adaptive-network-based fuzzy inference system," *IEEE T. Syst. Man. Cy.* vol. 23, pp. 665-685, 1993.

- [29] K. Guney and N. Sarikaya, "Adaptive neuro-fuzzy inference system for computing the resonant frequency of circular microstrip antennas," *ACES JOURNAL*, vol. 19, no. 3, 2004.
- [30] K. Guney and N. Sarikaya, "Computation of resonant frequency for equilateral triangular microstrip antennas using the adaptive neuro-fuzzy inference system," *International Journal of RF and Microwave Computer-Aided Engineering*, vol. 14, pp. 134-143, 2003.
- [31] N. V. Vapnik and A. Y. Chervonenkis, "The necessary and sufficient conditions for consistency in the empirical risk minimization method," *Pattern Recognition and Image Analysis*, vol. 1, no. 3, pp. 283-305, 1991.
- [32] N. T. Tokan and F. Gunes, "Support vector characterization of the microstrip antennas based on measurements," *Progress In Electromagnetics Research B*, vol. 5, pp. 49-61, 2008.

Ahmet Kayabasi was born in 1980. In 2001, he received B.S. degree in Electrical and Electronics Engineering from Selcuk University, Turkey. In 2005, he received M.S. degree in Electrical and Electronics Engineering from Selcuk University, Turkey. He has been working as lecturer at Electronics and Automation Department of Silifke-Tasucu Vocational School of Selcuk University since 2001. He received Ph.D. degree at Electrical and Electronics Engineering from Mersin University in 2015. His current research interests include antennas, microstrip antennas, computational electromagnetic, artificial intelligent and applications of optimization algorithms to electromagnetic problem such as radiation, resonance and bandwidth.

Ali Akdagli obtained the B.S., M.S. and Ph.D. degrees from Erciyes University, Kayseri, in 1995, 1997 and 2002 respectively, all in electronic engineering. From 2003 to 2006 he was an assistant professor in the electronic engineering department at Erciyes University. He joined the same department at Mersin University, where he currently works as a professor. He has published more than 90 papers in journals and conference proceedings. His current research interests include evolutionary optimization techniques (genetic algorithm, ant colony optimization, differential evolution, particle swarm optimization, and artificial bee colony algorithms), artificial neural networks and their applications to electromagnetic, microwave circuits, microstrip antennas and antenna pattern synthesis problems. Dr. Akdagli is an editorial board member of "Recent Patents on Electrical Engineering", *International Journal of Computers* and *Journal of Computational Engineering*.