

Heat Forging Analysis Method on Blank Consisting of Two Metals

Takashi Ueda, Shinichi Enoki

Abstract—Forging parts is used to automobiles; because, they have high strength and it is possible to press them into complicated shape. When it is possible to manufacture hollow forging parts, it leads to reduce weight of the automobiles. But, hollow forging parts are confined to axisymmetrical shape. Hollow forging parts that were pressed to complicated shape are expected. Therefore, we forge a blank that aluminum alloy was inserted in stainless steel. After that, we can provide complex forging parts that are reduced weight, if it is possible to be melted the aluminum alloy away by using different of melting points. It is necessary to establish heat forging analysis method on blank consist of stainless steel and aluminum alloy. Because, this forging is different from conventional forging and this technology is not confirmed. In this study, we compared forging experiment with numerical analysis on the view point of forming load and shape after forming and establish how to set the material temperatures of two metals and material property of stainless steel on the analysis method. Consequently, temperature difference of stainless steel and aluminum alloy was obtained by experiment. We got material property of stainless steel on forging experimental by compression tests. We had compared numerical analysis that was used the temperature difference of two metals and the material property of stainless steel on forging experimental with forging experiment. Forging analysis method on blank consist of two metals was established by result of numerical analysis having agreed with result of forging experiment.

Keywords—Forging, lightweight, analysis, hollow.

I. INTRODUCTION

AS one of countermeasures against global warming, it is needed to reduce the energy consumption of vehicles. Therefore, lightweight components are increasingly used in automobiles [1]-[3]. There have been a number of reports about it. For example, there are methods to make hollow parts of metal by back extrusion [4] and to use FRP that is lighter than metals [5]. But, shape that is formed by back extrusion has limited shape. Cost of FRP is more expensive than cost of the metals. Accordingly, forging by transverse compression that is possible to manufacture complex parts is usable method. Therefore, we provide forging of stainless steel inserting aluminum alloy. In the forging method, blank that aluminum alloy is inserted into stainless steel is pressed. So, it is more lightweight than conventional stainless steel parts. It is possible to manufacture hollow forging parts, if aluminum alloy melts out using difference of melting points. But, we think that establish heat forging analysis method is necessary. Because,

the forming blank is different from conventional forging and this forging technology is not confirmed. Therefore, the purpose in this study is to establish forging analysis method on blank with two metals. As the method, we compared forging experiment with numerical analysis on the view point of forming load and shape after forming and establish how to set the material temperatures of two metals and material property of stainless steel on the analysis method.

II. ANALYSIS METHOD

A. Analysis Model

Numerical analysis in this study was forging analysis that blank was functioned transverse compression load by rectangular die as shown in Fig. 1 (a). Stainless steel is SUS304 (JIS G4318). Aluminum alloy is A2017 (JIS H4040). The blank size is shown in Fig. 1 (b). Upper die and lower die are rigid body model. The lower die is fixed and the upper die is had forming velocity on each stroke as shown in Fig. 2. In addition, stroke is 2.84mm. Coulomb friction coefficient and shear friction coefficient gave 0.5 on all contact surfaces. We analyzed it by metal forming process simulation system Simufact.forming (Simufact engineering GmbH). Additionally, blank model was used 1/4 model such as Fig. 1 (c).

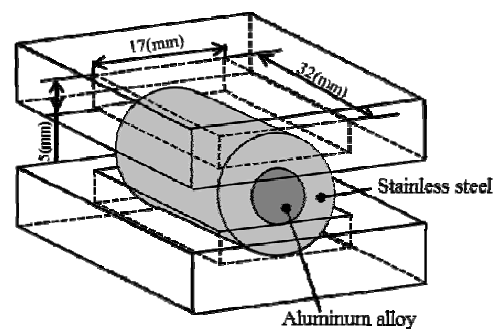

(a) Forging model

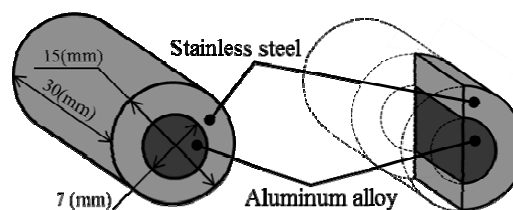

(b) Forging test piece

(c) 1/4 model in numerical analysis

Fig. 1 Forging by test piece employing two materials

T. Ueda is with the Nara National College of Technology.

S. Enoki is with the Nara National College of Technology, 22 Yata-cho, Yamatokoriyama, 639-1080, Japan (phone: +81-743-55-6000; fax: +81-743-55-6019; e-mail: enoki@mech.nara-k.ac.jp).

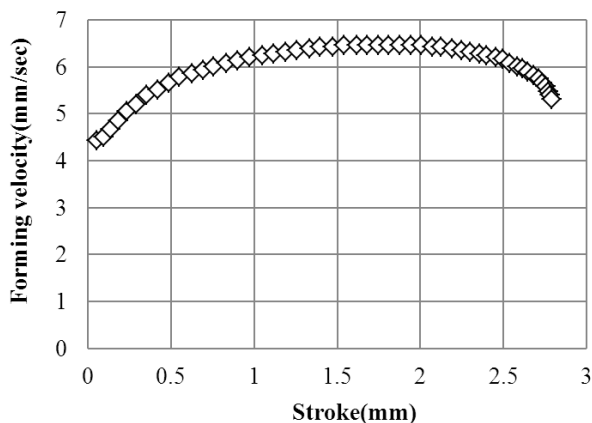

Fig. 2 Relation between forming velocity and stroke

B. Material Temperature

A blank used in this study is that aluminum alloy bar is inserted in stainless steel pipe. The blank was heated to 700°C which is over the recrystallization temperature of stainless steel by using an electric furnace (SUPER 100T, Shimada electric furnace). The aluminum alloy bar was melted in this experiment. This reason seems to be that the aluminum alloy bar is covered in radial direction by the stainless steel pipe. Therefore, aluminum alloy at room-temperature was inserted into stainless steel pipe heated at 700°C as a blank in this study. In this method, it is thought that temperature of aluminum alloy is different from stainless steel, because temperature of aluminum alloy is risen by heated stainless steel. Consequently, we confirmed temperature distribution of the blank that inserted aluminum alloy into heated stainless steel by thermography. As the result, stainless steel is about 300~400°C. Aluminum alloy showed is 100~200°C. But, temperature value on thermography has lower reliability, because thermography performs only ambient temperature. However, it is possible to use temperature difference of stainless steel and aluminum alloy. Therefore, temperature difference 200°C of stainless steel and aluminum alloy was applied to the forging analysis.

C. Material Property

It is necessary to confirm material property of stainless steel in forging experiment. Therefore, material property of stainless steel in forging experiment is got by compression test. Test pieces were stainless steel cylinder that diameter and height are 15(mm). As experiment method, we took method that the test pieces were compressed with servo press (H1F60, KOMATSU) to stroke 4mm. Temperature conditions are two cases. First case is stainless steel that was heated for 20 minutes by electric furnace. Then, electric furnace was set at 700°C. Second case is stainless steel that was had ambient temperature. From above-mentioned, the material property was got by compression tests. Material properties of stainless steel are shown in Fig. 3.

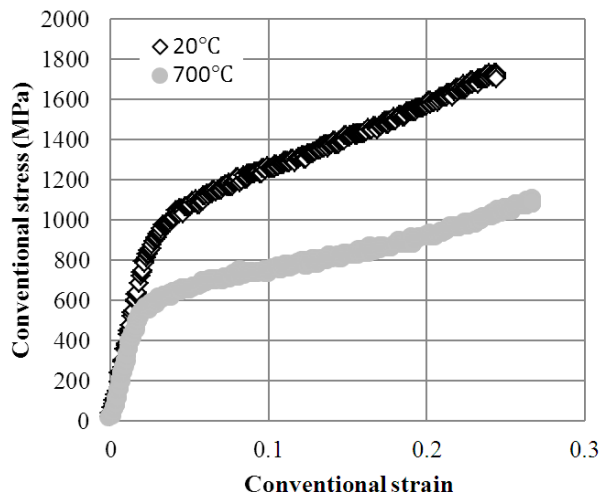

Fig. 3 Relations between conventional stress and conventional strain from compaction test at 20°C and 700°C

III. ESTABLISHMENT OF ANALYSIS METHOD

Comparison of forging experiment and numerical analysis is necessary to establish forging analysis method on blank that consists of two metals. Therefore, we perform forging experiment using blank that aluminum alloy was inserted into stainless steel.

A. Forging Experiment

In forging experiment, transverse compression load was performed to the blank by two rectangular dies like the numerical analysis. We used stainless steel (SUS304 JIS G4318) and aluminum alloy (A2017 JIS H4040). As heat condition, the method that aluminum alloy that was had ambient temperature was inserted into heated stainless steel was used. The heated blank in this study was given transverse compression load by the servo press. In addition, stroke in forging experiment is 2.84(mm).

B. Comparison of Forging Experiment and Numerical Analysis

We compare of forging experiment and two cases numerical analysis. In the first case, material property of stainless steel was set property that was provided by compression test and material property of aluminum alloy was set by the database of simfact.forming. In the second case, material property with both stainless steel and aluminum alloy were set by the database of simfact.forming. As temperature condition, temperature of stainless steel is 700°C that is setting temperature in electric furnace at the time of the forging experiment. Temperature of aluminum alloy is 500°C that was decided by temperature difference that was given of thermography. In addition, material constant of stainless steel is Poisson's ratio 0.3, mass density 7850(kg/m³), heat expansion coefficient 1.9×10^{-5} (1/K). Young's modulus, thermal conductivity, and specific heat were shown relation on each temperature in Figs. 4-6.

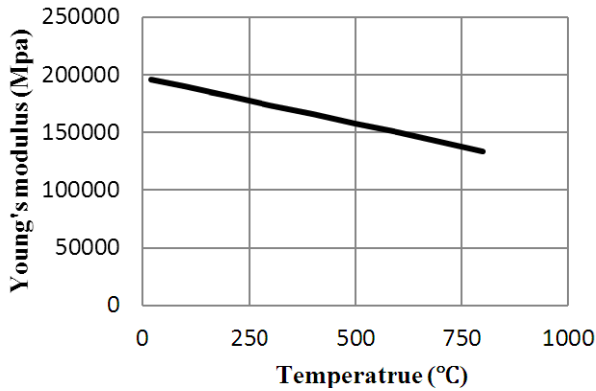

Fig. 4 Relation between young's modulus and temperature

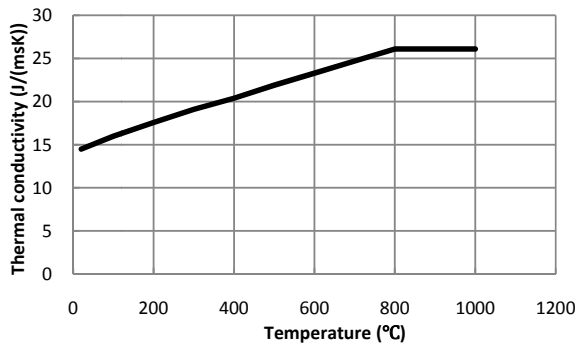

Fig. 5 Relation between thermal conductivity and temperature

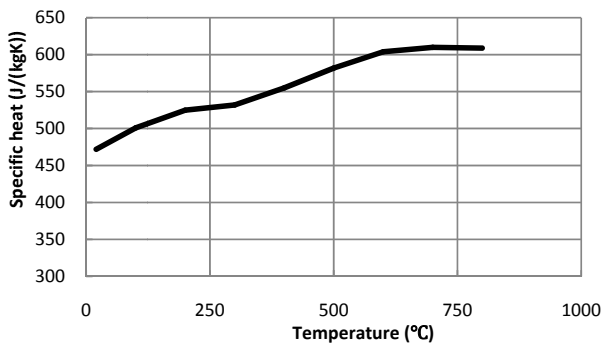

Fig. 6 Relation of specific heat and temperature

Two case results were got by numerical analysis using above-mentioned condition. We show relation between forming load and stroke in Fig. 7, and comparison of forging experiment and two cases numerical analysis.

As shown in Fig. 7, the forming load in the forging experiment coincided with the result in numerical analysis using material property that was provided by compression tests. But, there is great difference between result of numerical analysis using material property in simufact.forming and result of forging experiment. Next, Fig. 8 is shape of cross section that was given by forging experiment. Fig. 9 is shape of cross section that was given by numerical analysis using material property that was provided by compression tests. Fig. 10 is

shape of cross section that was given by material property in database of simufact.forming. In addition, Table I is dimension of cross section shape after forming.

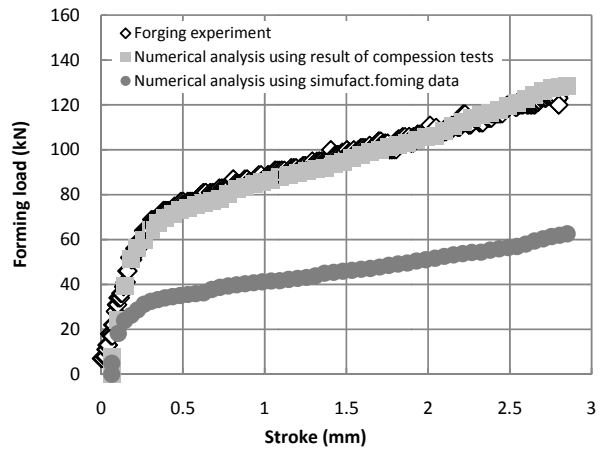

Fig. 7 Relation of forming load and stroke



Fig. 8 Cross section shape after forming in forging experiment

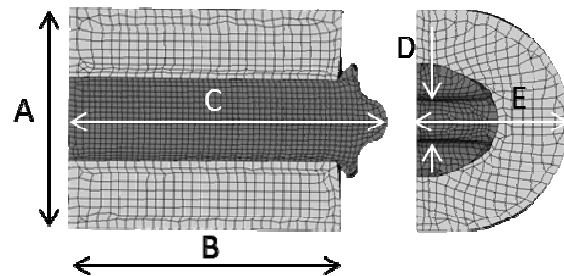

Fig. 9 Shape of cross section in using result of compaction test

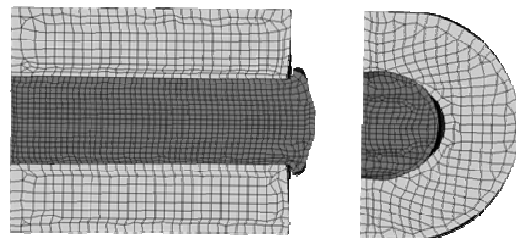

Fig. 10 Shape of cross section in using database of simufact.forming

TABLE I
DIMENSION OF CROSS SECTION SHAPE

Dimension	Forging experiment	Using compaction test result	Database of simufact.forming
A	12.2mm	12.2mm	12.2mm
B	15.3mm	15.32mm	15.38mm
C	17.5mm	17.63mm	16.53mm
D	2.35mm	2.33mm	3.15mm
E	8.3mm	8.37mm	8.38mm

Cross section shape in Fig. 8 was cut blank on forging experiment by fine cutter. Blank after forming in Figs. 8 and 9 distort uniformly. Burr of aluminum alloy in end-face is pressed by dies. However, in Fig. 10, burr of aluminum alloy is not formed. As shown in Table I, dimension after forming in the forging experiment and the numerical analysis using material property of compaction test are almost identical. It has been felt that the numerical analysis using material property of compression tests is the same as the forging experiment by Fig. 8 and the blank after forming. Therefore, effectual numerical analysis is case setting temperature difference 200°C of blank and using material property of stainless steel that was provided by compression tests.

IV. CONCLUSION

Purpose in this study was erection of forging analysis method on blank that aluminum alloy was inserted in stainless steel. For this purpose, following result was received.

- (1) It was provided that temperature difference between aluminum alloy and stainless steel was 200°C by thermograph.
- (2) Material property of stainless steel on heat condition of this study was given by compression tests.
- (3) We erected forging analysis method on blank with two metals from temperature difference of blank and material property of stainless steel that was provided by compaction test.

ACKNOWLEDGMENT

This work was supported by JSPS KAKENHI Grant Number 24560150.

REFERENCES

- [1] Kleiner M, Geiger M, Klaus A Manufacturing of Lightweight Components by Metal Forming. 2003,Annals of the CIRP 52(2) 521-542.
- [2] H Helms, U Lambrecht The Potential Contribution of Light-Weighting to Reduce Transport Energy Consumption. 2006, Int JLCA, 7
- [3] C Juan, G Palencia, T Furubayashi, T Nakata Energy use and CO₂ emissions vehicles and lightweight materials. 2012. Energy 48 pp548-565.
- [4] R Matsumoto, S Sawa, H Utsunomiya, K Osakada Prevention of galling in forming of deep hole with retreat and advance pulse ram motion on servo press. 2011,Annals of the CIRP 60 315-318.
- [5] Joost R Duflou, Deng Yelin, Krael Van Acker, Wim Deulf Comparative impact assessment for flax fibre versus conventional glass fibre reinforced composites: Are bio-based reinforcement materials the way to go? 2014,Annals of the CIRP.