

Efficiency Improvement for Conventional Rectangular Horn Antenna by Using EBG Technique

S. Kampeephat, P. Krachodnok, R. Wongsan

Abstract—The conventional rectangular horn has been used for microwave antenna a long time. Its gain can be increased by enlarging the construction of horn to flare exponentially. This paper presents a study of the shaped woodpile Electromagnetic Band Gap (EBG) to improve its gain for conventional horn without construction enlargement. The gain enhancement synthesis method for shaped woodpile EBG that has to transfer the electromagnetic fields from aperture of a horn antenna through woodpile EBG is presented by using the variety of shaped woodpile EBGs such as planar, triangular, quadratic, circular, gaussian, cosine, and squared cosine structures. The proposed technique has the advantages of low profile, low cost for fabrication and light weight. The antenna characteristics such as reflection coefficient (S_{11}), radiation patterns and gain are simulated by utilized A Computer Simulation Technology (CST) software. With the proposed concept, an antenna prototype was fabricated and experimented. The S_{11} and radiation patterns obtained from measurements show a good impedance matching and a gain enhancement of the proposed antenna. The gain at dominant frequency of 10 GHz is 25.6 dB, application for X- and Ku-Band Radar, that higher than the gain of the basic rectangular horn antenna around 8 dB with adding only one appropriated EBG structures.

Keywords—Conventional Rectangular Horn Antenna, Electromagnetic Band Gap, Gain Enhancement, X- and Ku-Band Radar.

I. INTRODUCTION

A HORN antenna is widely used as antenna at Ultra-High Frequency (UHF) and microwave frequency, above 300 MHz [1], [2], a type of aperture antenna, which provides the moderately high gain as compared to the other antennas. Consequently, the horn antenna is widely applied for various tasks. A horn antenna has been used in many applications, such as satellite communications, radio astronomy, radar or remote sensing [3], [4]. They are used as feeders for larger antenna structures, as standard calibration antennas to measure the gain of other antennas, and as directive antennas [5], [6]. Their widespread applicability stems from their simplicity in construction, ease of excitation, versatility, large gain, and preferred overall performance [7]. Applications requiring high gain antenna such as the parabolic reflector can be applied with the horn antenna to enhance the higher gain. The insertion of a thin metallic strip into a horn is briefly discussed [8]. The metallic strip is reported to improve the plane directivity of a horn, but it is suggested that mismatch

problems make the technique impractical. Moreover, techniques for improving the performance of a wide-flare pyramidal horn antenna, metallic baffles are placed inside the horn near its throat the antenna's performance is improved significantly [9]. The metal baffles are simple planar structures that reduce phase curvature at the aperture like a lens. However, the disadvantages of metallic are heavy, bulky and not easy to integrate with monolithic microwave integrated circuits (MMICs) components. The smooth walled conical horn (SWCH), by virtue of its desirable qualities such as high gain, construction simplicity and ease of excitation, is used as a standard gain antenna, as a feed for reflectors and in polarization diversity systems [10]. On the other hand, its poor pattern symmetry and high cross-polar radiation level make it unsuitable for high performance applications. Much research has been devoted to high performance conical horns such as corrugated horn, lens corrected horn and multimode horn [11]. These horns, however, in general impose construction difficulties, and are often heavy, bulky and costly.

Wongsan et al. presented an additional Electromagnetic Band Gap (EBG) to improve the gain of a rectangular horn antenna by using woodpile EBG structures, transfer the power from its aperture through EBG structures [12]-[15]. By employing, EBG structures as high-impedance ground planes [16], as planar reflectors [17], or as substrates [18], they are able to eliminate the drawbacks of conducting ground-planes, to prevent the propagation of surface waves, to lower the device profiles, and to improve the performances of antennas, enhancing their directivity and the radiation efficiency. Moreover, they can be formed from dielectric structures that are periodic in one or more dimensions [19]. Therefore, this paper presents a study of the technique to enhance the gain of a conventional rectangular horn antenna by using a variety of shaped woodpile EBG such as planar, triangular, quadratic, circular, gaussian, cosine, and squared cosine structures. They are creating new possibilities for controlling and manipulating the flow of electromagnetic waves. Also, this paper designs to simulate and fabricate a horn antenna with EBG structures based on low loss alumina materials at dominant frequency of 10 GHz, and demonstrate its use in a horn antenna for X- and Ku-Band Radar.

At first, the general approach will be presented which is including the configurations of a rectangular horn antenna, which is improved gain and radiation patterns by adding two side-wing slabs, and the woodpile EBG structures as shown in Sections II and III, respectively. Next, the simulated results of antenna characteristics are calculated by using CST software and discussed in the Section IV.

S. Kampeephat, P. Krachodnok, and R. Wongsan are with the School of Telecommunication Engineering, Institute of Engineering, Suranaree University of Technology, Nakhon Ratchasima, CO 30000 Thailand (phone: +668 1955 2414; fax: +66 4422 4603 e-mail: D5240388@g.sut.ac.th, priam@sut.ac.th, and rangsan@sut.ac.th).

II. HORN ANTENNA CONFIGURATION

A. A Conventional Rectangular Horn Antenna

A horn antenna may be considered as a transformer from the impedance of a transmission line to the impedance of free space, 377Ω . A common microwave transmission line is waveguide, a hollow pipe carrying an electromagnetic wave. The horn antenna consists of a flaring metal waveguide for guiding the radio waves into free space. The design of a conventional rectangular horn antenna (*Type-A* horn) is initiated by determining its aperture dimension as follow [6], with the gain of 17.67 dB, as shown in Fig. 1.

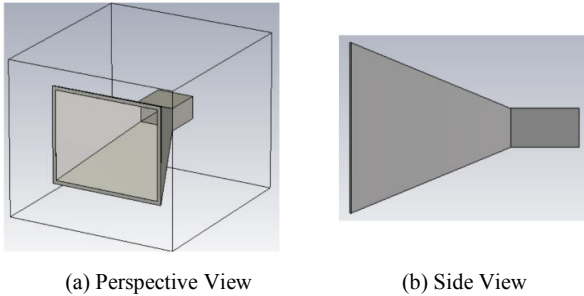

Fig. 1 A conventional rectangular horn antenna (*Type-A* horn)

B. A Horn Antenna with Two Side-Wing Slabs

To improve the radiation pattern and gain characteristics, a conventional rectangular horn antenna will be add two side-wing slabs on the left and right sides (*Type-B* horn) [14] to control the half-power beamwidth (HPBW) symmetrically in the E- and H-Plane as shown in Fig. 2. The design dimension for each side-wing slab is $5\lambda/8$, approximately. The simulated result show that the HPBW, which shown as the ratio of azimuth pattern to evaluation pattern (AZ:EL), of a *Type-B* horn is $20.6^\circ:21.7^\circ$ (1:1.05) at the gain of 18.08 dB.

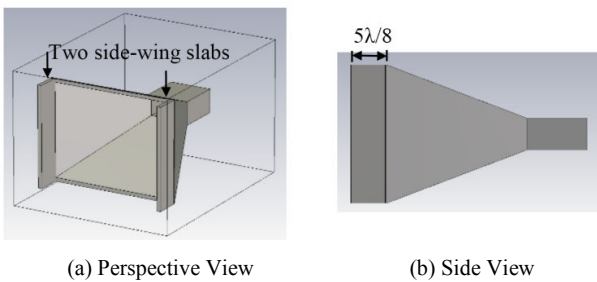

Fig. 2 A conventional rectangular horn antenna with two side-wing slabs (*Type-B* horn)

III. EBG CONFIGURATION

A woodpile is a three-dimension EBG structures made of a stack of square cross-section rod. The unit cell of these structures is shown in Fig. 3. The dimension of woodpile EBG structures is specified by the distance in the horizontal plane (a), the rod width (w), and the rod height (h). To implement the woodpile, this paper has used alumina rods ($\epsilon_r = 8.4$, $\tan\delta = 0.002$) that have a rectangular cross section. The lattice

parameters are given as follow [12] with $a = 0.225\lambda$ and $w = h = 0.064\lambda$.

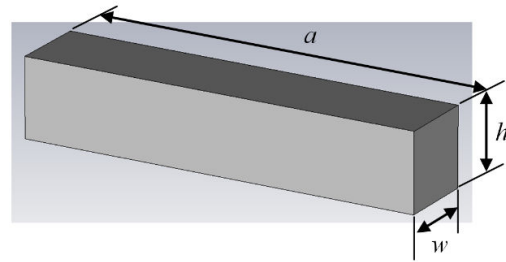

Fig. 3 The unit cell of woodpile EBG rod

To align shaped woodpile EBG structures, this paper has used functions of geometries from [20] as shown in Table I

TABLE I FORMULATIONS OF ELEMENTARY GEOMETRICAL FUNCTION		
Distributed functions	Formulations	Shapes of EBG Structures
Planar	-	
Triangular	$f(x,y)=A\left(1-\frac{2}{D}\sqrt{x^2+y^2}\right)$	
Quadratic	$f(x,y)=A\left[1-\left(\frac{2}{D}\sqrt{x^2+y^2}\right)^2\right]$	
Circular	$f(x,y)=A\sqrt{1-\left(\frac{2}{D}\sqrt{x^2+y^2}\right)^2}$	
Gaussian	$f(x,y)=Ae^{-\left(\frac{2}{D}\sqrt{x^2+y^2}\right)^2}$	
Cosine	$f(x,y)=A\cos\left(\frac{\pi}{D}\sqrt{x^2+y^2}\right)$	
Squared Cosine	$f(x,y)=A\cos^2\left(\frac{\pi}{D}\sqrt{x^2+y^2}\right)$	

IV. SIMULATED RESULTS AND DISCUSSIONS

The configuration of each model consists of a rectangular horn antenna with two side-wing slabs and various shaped woodpile EBG structures such as planar, triangular, quadratic, circular, gaussian, cosine, and squared cosine structures as shown in Fig. 4.

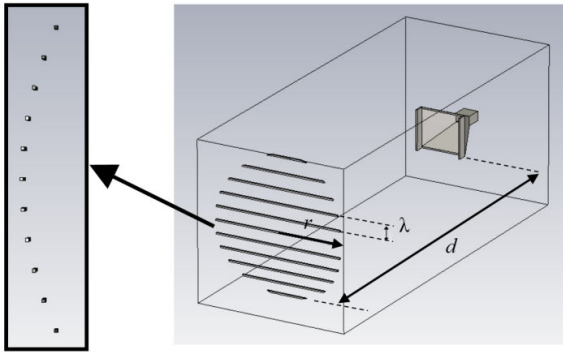

Fig. 4 A rectangular horn antenna with two wing slabs and various shaped woodpile EBG

The design parameters of the gain improvement for a *Type-B* horn are the various shaped woodpile EBG structures, the distance between a *Type-B* horn and woodpile EBG structures (d), and the radius of quadratic shaped (r). Firstly, we look at the effect of the variation of shaped woodpile EBG structures; d and r are fixed at 30λ and 5λ , respectively. Fig. 5 shows the gain against the various shaped woodpile EBG structures at operating frequency of 10 GHz. The highest gain of 24.34 dB is provided when the woodpile EBG structure is quadratic shaped. Also, the appropriate HPBW in the E- and H-plane are the narrowest. Therefore, the quadratic-shaped woodpile EBG is used to gain some parts of the electromagnetic energy and suppress the surface wave that occurred on the slabs. Secondly, we look at the effect of the variation of distance d , and r is fixed at 5λ . Fig. 6 shows the gain against the d at dominant frequency of 10 GHz. The highest gain of 25.70 dB is provided at d of 16.5λ . Next, we have been studied the effect of the r variation on the gain of a rectangular horn antenna with two side-wing slabs and quadratic-shaped woodpile EBG (*Type-C* horn), while d is fixed at 16.5λ , thus the result is improved as shown in Fig. 7. We found that the gain is increased from 25.70 dB to 25.74 dB at r equal to 5.3λ approximately. Moreover, it evidently provides the symmetrical radiation patterns both in E- and H-plane and moderately higher gain around 8 dB when compared to single horn.

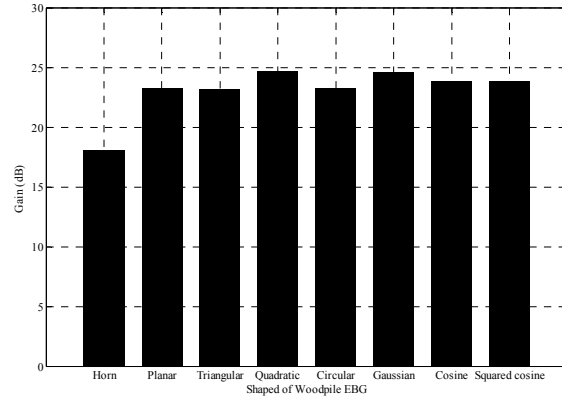

Fig. 5 Simulated gain against the various shaped woodpile EBG of a *Type-B* horn

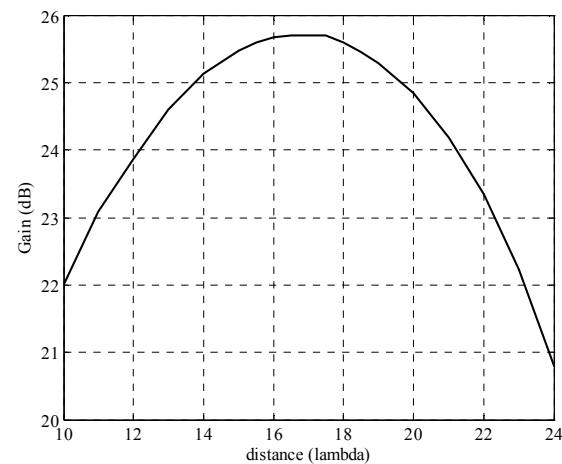

Fig. 6 Simulated gain against d of a *Type-B* horn

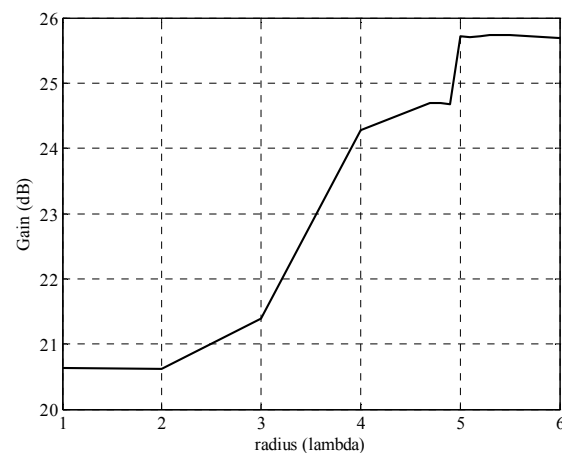

Fig. 7 Simulated gain against r of a *Type-B* horn

Finally, the highest gain of a *Type-C* horn is optimized with $d = 16.5\lambda$ and $r = 5.3\lambda$. The S_{11} (-10 dB), covered 8 to 12 GHz, which are wide enough and can be well utilized for X- and Ku-Band Radar as shown in Fig. 8. The normalized radiation

patterns at dominant frequency of 10 GHz of these horn antennas as shown in Fig. 9, we found that the radiation patterns of *Type-C* horn in both planes are quite symmetry (AZ:EL=6.9°:6.8° or 1.01:1). Also, the HPBW, the Side Lobe Levels (SLLs), and the gains are shown in Table II.

TABLE II
RESULTS OF SIMULATION

Parameters	Type-A horn	Type-B horn	Type-C horn
The HPBW (AZ:EL)	24°:21.7° 1.11:1	20.6°:21.7° 1:1.05	6.9°:6.8° 1.01:1
The E-plane SLL	-18.1 dB	-18.1 dB	-16.5 dB
The H-plane SLL	-22.2 dB	-26.4 dB	-20.0 dB
The Gain	17.67 dB	18.08 dB	25.74 dB

TABLE III
RESULTS OF MEASUREMENT

Parameters	Simulated Results	Measured Results
The HPBW (AZ:EL)	6.9°:6.8° 1.01:1	7.1°:7° 1.01:1
The E-plane SLL	-16.5 dB	-16 dB
The H-plane SLL	-20.0 dB	-19 dB
The Gain	25.74 dB	25.6 dB

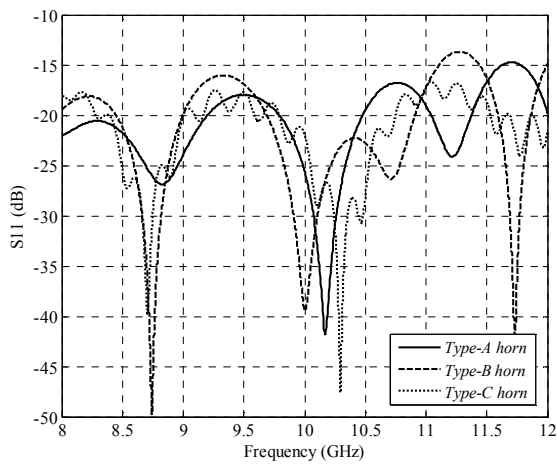

Fig. 8 Simulated reflection coefficient of the three type horns

V. EXPERIMENTAL RESULTS AND DISCUSSIONS

A *Type-C* horn antenna prototype has been simulated with the CST software and fabricated to validate the proposed concept. The geometry of a *Type-C* horn antenna in Fig. 4 is used. It consists of a rectangular horn antenna with two side-wing slabs, its dimension for each side-wing slab of $5\lambda/8$, and quadratic-shaped woodpile EBG structures which is optimized with the distance between a rectangular horn antenna with two side-wing slabs and woodpile EBG structures of 16.5λ and the radius of quadratic shaped of 5.3λ . Fig. 10 shows photograph of the fabricated proposed antenna. The simulated and measured the S_{11} of the proposed antenna are shown in Fig. 11. A good agreement is obtained between theoretical and measured results. From the measured curve, a bandwidth from 8 to 12 GHz is achieved, which is enough to cover the X- and

Ku-Band Radar. A further study of the proposed antenna has focused on its radiation performance. The radiation patterns of the proposed antenna were measured in the outdoors. The measured and simulated radiation patterns are shown in Fig. 12. We found that the radiation patterns of the proposed antenna are quite symmetry in both planes. With reference to these curves, a good agreement between predictions and measured data can be observed. The measured gain of the proposed antenna is 25.6 dB at 10 GHz. These measurements are unique and very positives. The HPBW, the SLLs, and the gains of the measured and simulated are shown in Table III.

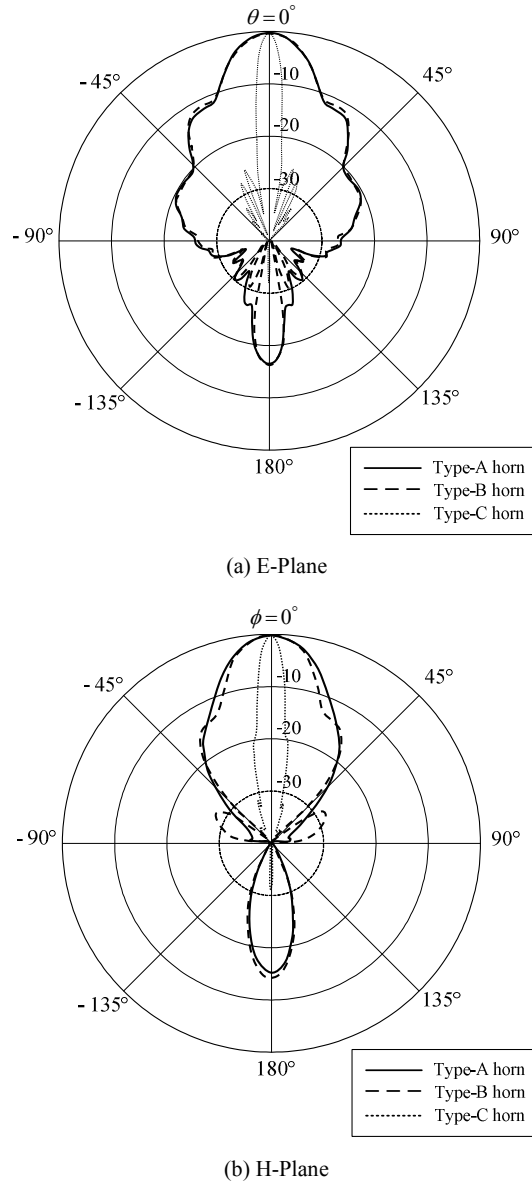

Fig. 9 Simulated normalized radiation patterns of the three type horns

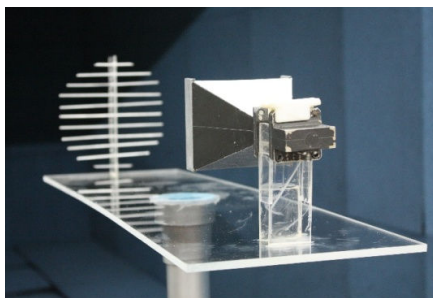

Fig. 10 A photograph of the fabricated proposed antenna

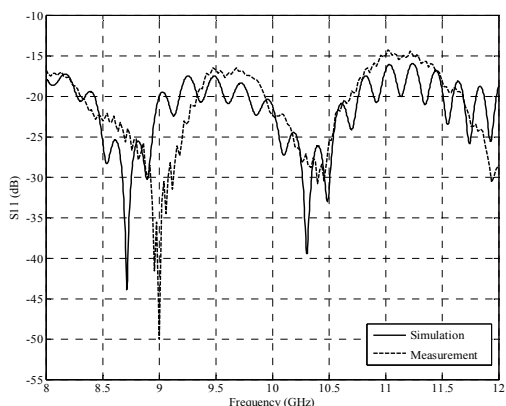

Fig. 11 The reflection coefficient of the proposed antenna

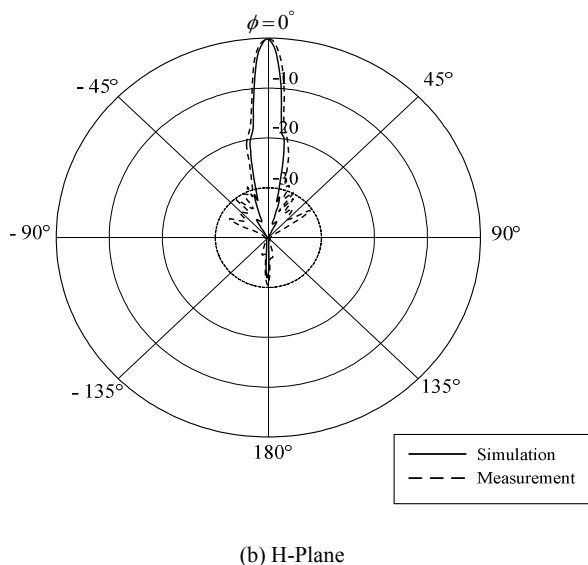
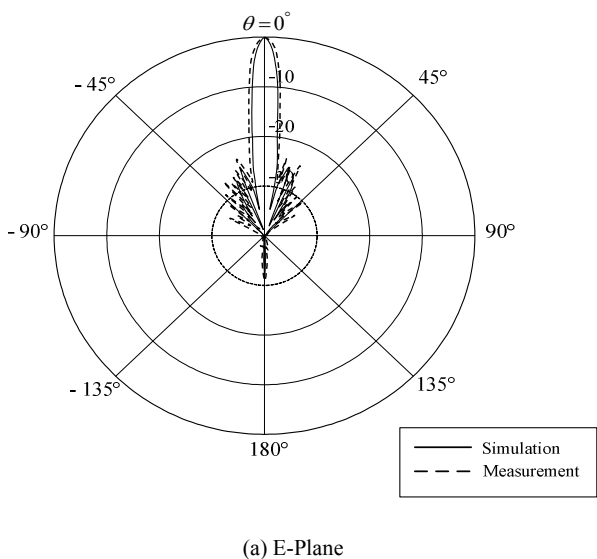

Fig. 12 The normalized radiation patterns of the proposed antenna

VI. CONCLUSION

This paper presented the gain improvement of a horn antenna by modifying the conventional rectangular horn with adding two side-wing slabs on the left and right sides to control the HPBW symmetrically in the E- and H-Plane and increasing its gain with new technique, additional quadratic-shaped woodpile EBG. From the results, it evidently provides not only the symmetrical radiation patterns both in E- and H-plane but also the moderately higher gain around 8 dB when compared to a single horn antenna. The various shaped woodpile EBG structures, the distance between a horn antenna and woodpile EBG structures, and the radius of quadratic shaped are the parameters for this accomplishment especially the shaped woodpile EBG structures that is the most important technique must be appropriately designed and calculated for a horn antenna. The most proper the distance between a horn antenna and woodpile EBG structures of 16.5λ and the radius of quadratic shaped of 5.3λ can provide the moderately highest gain of 25.6 dB at the operating frequency of 10 GHz. Therefore, this proposed antenna accords to the requirements and is appropriated for an X- and Ku-Band Radar.

ACKNOWLEDGMENT

This work was supported by the National Research Council of Thailand (NRCT) and the Research Department Institute of Engineering, Suranaree University of Technology, Nakhon Ratchasima, Thailand.

REFERENCES

[1] P. Bevilaqua, "The Horn Antenna," 2009-2011. <http://www.antenna-theory.com/antennas/aperture/horn.php>

[2] P. de Maagt, R. Gonzalo, Y. C. Vardaxoglou, and J. M. Baracco, "Electromagnetic bandgap antennas and components for microwave and (sub) millimeter wave applications," *IEEE Transactions on Antennas and Propagation*, Vol. 51, No. 10, 2003, pp. 2667-2677.

[3] A.W. Love, "Electromagnetic horn antennas," IEEE Press, New York, 1976.

- [4] A.D. Olver, P.J.B. Clarricoats, L. Shafai, and A.A. Kishk, "Microwave horns and feeds," IEEE Press, New Jersey 1994.
- [5] I. Poole, "Horn antenna," 2010. http://www.radio-electronics.com/info/antennas/horn_antenna/horn_antenna.php
- [6] K. A. Bakshi, A.V. Bakshi, and U.A. Bakshi, "Antennas and Wave Propagation," *Technical Publications*, 2009.
- [7] A. B. Constantine, "Antenna theory: Analysis and Design," Wiley-Interscience, 2005.
- [8] S. Silver, "Microwave Antenna Theory and Design," McGraw-Hill, 1949.
- [9] M. A. Koerner and R. L. Rogers, "Gain Enhancement of a Pyramidal Horn Using E- and H-Plane Metal Baffles," *IEEE Transactions on Antennas and Propagation*, Vol. 48, No. 4, 2000, pp. 529-538.
- [10] V. Rodriguez, "A brief history of horns," *In Compliance Magazine*, November 2010.
- [11] M. Clenet and L. Shafai, "Investigations on Directivity Improvement of Wide Flare Angle Conical Horns Using Inserted Metallic Discs," *IEE Proceedings on Microwaves Antennas and Propagation*, Vol. 147, No. 2, 2000, pp. 100-105.
- [12] S. Kampeephat, P. Krachodnok, and R. Wongsan, "A Study of Gain Enhancement of Horn Antenna Using EBG," in *The 2012 IEEE Asia-Pacific Conference on Antennas and Propagation (APCAP 2012)*, Singapore, August 2012, pp. 195-196.
- [13] S. Kampeephat, P. Krachodnok, and R. Wongsan, "A Study of Gain Enhancement of Horn Antenna Using Various Shaped Woodpile EBG," in *The 2012 Thailand-Japan MicroWave (TJMW 2012)*, Bangkok, Thailand, August 2012.
- [14] S. Kampeephat, P. Krachodnok, and R. Wongsan, "Gain Improvement for Rectangular Horn Antenna with Additional EBG," in *The 2013 Thailand-Japan MicroWave (TJMW 2013)*, Bangkok, Thailand, December 2013.
- [15] S. Kampeephat, P. Krachodnok, and R. Wongsan, "Gain Improvement for Conventional Rectangular Horn Antenna with Additional EBG Structure," in *The 2014 International Conference on Electrical Engineering/Electronics, Computer, Telecommunications and Information Technology (ECTI-CON 2014)*, Nakhon Ratchasima, Thailand, May 2014.
- [16] F. Yang and Y. Rahmat-Samii, "Reflection phase characterizations of the EBG ground plane for low profile wire antenna applications," *IEEE Transactions on Antennas and Propagation*, Vol. 51, No. 10, 2003, pp. 2691-2703.
- [17] M. Thevenot, C. Cheype, A. Reineix, and B. Jecko, "Directive Photonic Band-Gap Antennas," *IEEE Transactions on Microwave Theory and Techniques*, Vol. 47, No. 11, 1999, pp. 2115-2122.
- [18] R. Gonzalo, P. J. I. de Maagt, and M. Sorolla, "Enhanced Patch Antenna Performance by Suppressing Surface Waves Using Photonic Band-Gap Structures," *IEEE Transactions on Microwave Theory and Techniques*, Vol. 47, No. 11, 1999, pp. 2131-2138.
- [19] F. Yang and Y. Rahmat-Samii, "Electromagnetic Band Gap Structures in Antenna Engineering," Cambridge University Press, Cambridge, 2009.
- [20] V. Thavirot, P. Krachodnok, and R. Wongsan, "Radiation Pattern Synthesis from Various Shaped Reflectors Base on PO and PTD Methods for Point-to-Multipoint Applications," *WSEAS Transactions on Communications*, Vol. 7, No. 6, 2008, pp. 531-540.



S. Kampeephat was born in Surat Thani, Thailand, in 1984. He received the B.Eng. degree and the M.Eng. degree in telecommunication engineering from Suranaree University of Technology, Thailand, in 2007 and 2009, respectively. He is currently working toward the Ph.D. degree in telecommunication engineering at Suranaree University of Technology.

His research interests include Electromagnetic Theory, Antenna Engineering and Electromagnetic Band Gap.

Mr. Kampeephat is the member of the Electrical Engineering/Electronics, Computer, Telecommunications and Information Technology Association (ECTI).



P. Krachodnok was born in Khon Kaen, Thailand, in 1974. She received the B.Eng. degree in telecommunication engineering from Suranaree University of Technology, Thailand, in 1997, M.Eng. degree in Electrical Engineering from Chulalongkorn University, Thailand, in 2001, and D.Eng. degree in telecommunication engineering from Suranaree University of Technology, Thailand, in 2008.

She received the APCC2007 Best paper award, IEEE Asia-Pacific Conference on Communications, Bangkok, Thailand. She is the reviewer of IEEE Conference. Her research interests are Electromagnetic Theory, Microwave Engineering, Antenna Engineering, and Electromagnetic Band Gap.

Assist Prof. Dr. Krachodnok is the member of the Electrical Engineering/Electronics, Computer, Telecommunications and Information Technology Association (ECTI) and The Institute of Electronics, Information and Communication Engineers (IEICE).



R. Wongsan was born in Rayong, Thailand, in 1964. He received his B.Eng. degree in Electronics Engineering at Rajamangala Institute of Technology in 1989, Thewes campus, M.Eng. degree in Electrical Engineering at King Mongkut's Institute of Technology, North Bangkok (KMITNB) in 1994, and D.Eng. degree in Electrical Engineering at King Mongkut's Institute of Technology Ladkrabang (KMILT) in 2003.

At present, he is the reviewer of many journals related to the electromagnetic applications society. His almost researches are in the antenna theory and electromagnetic applications. Currently, his research interests are the utilization of the Electromagnetic Band Gap for the efficiency improvement of conventional antennas and microwave devices.

Assoc. Prof. Dr. Wongsan is the member of the Electrical Engineering/Electronics, Computer, Telecommunications and Information Technology Association (ECTI) and The Institute of Electronics, Information and Communication Engineers (IEICE).