

Investigation of the Flow Characteristics in a Catalytic Muffler with Perforated Inlet Cone

Gyo Woo Lee, Man Young Kim

Abstract—Emission regulations for diesel engines are being strengthened and it is impossible to meet the standards without exhaust after-treatment systems. Lack of the space in many diesel vehicles, however, make it difficult to design and install stand-alone catalytic converters such as DOC, DPF, and SCR in the vehicle exhaust systems. Accordingly, those have been installed inside the muffler to save the space, and referred to the catalytic muffler. However, that has complex internal structure with perforated plate and pipe for noise and monolithic catalyst for emission reduction. For this reason, flow uniformity and pressure drop, which affect efficiency of catalyst and engine performance, respectively, should be examined when the catalytic muffler is designed. In this work, therefore, the flow uniformity and pressure drop to improve the performance of the catalytic converter and the engine have been numerically investigated by changing various design parameters such as inlet shape, porosity, and outlet shape of the muffler using the three-dimensional turbulent flow of the incompressible, non-reacting, and steady state inside the catalytic muffler. Finally, it can be found that the shape, in which the muffler has perforated pipe inside the inlet part, has higher uniformity index and lower pressure drop than others considered in this work.

Keywords—Catalytic muffler, Perforated inlet cone, Catalysts, Perforated pipe, Flow uniformity, Pressure drop.

I. INTRODUCTION

DIESEL engines have a higher durability, thermal efficiency, and less CO₂ emission which is one of the culprits of global warming, than gasoline engines. For this reason, that has been widely used all over various industries. However, emission regulations are being strengthened as years go by, it made exhaust after treatment systems of the diesel engine essential and various engine techniques required in order to decrease the exhaust emissions, and development of exhaust after treatment systems are needed [1]-[3]. In general, the flow is very complex inside the catalytic muffler and induces the non-uniform flow patterns in front face of the monolith, and that causes the malfunction and/or low conversion efficiency of the catalysts. Retaining uniform flow to prevent performance reduction of the catalysts, therefore, is very important.

Like this, numerous studies to obtain the uniform flow have been conducted with three-dimensional flow characteristics, air gap length, and angle of the diffuser at air gap through cone shape optimization of inlet and outlet [4]-[6]. And study on various cell shapes with concentration limit of flow to increase

conversion efficiency of the catalyst has investigated [7], [8]. Likewise, change of uniformity index with inserts such as pulse generator or vane was investigated through the comparison of the performance index and flow characteristics with parametric results [9], [10]. However, study on the flow uniformity in front of the catalyst inside the muffler which has perforated plate and pipe cannot be easily found in the literature due to the complex shape and turbulent characteristic of the flow.

In this work, flow characteristics inside the different possible configurations of catalytic muffler are investigated numerically. After developing the mathematical models adopted in this work firstly, model validation work by comparing the pressure drop values with experimental ones is conducted. In order to evaluate the flow performance of the catalytic muffler, three different types of flow characteristics such as streak lines inside the catalytic muffler, flow uniformity index in front of the first catalyst DOC, and pressure drop between the inlet and outlet pipes are investigated in the following. Finally, some concluding remarks are presented.

II. MATHEMATICAL FORMULATION

A. Governing Equations

Internal flow is assumed to be three-dimensional turbulent flow of incompressible, non-reacting, and steady state to investigate the optimum flow characteristics of the catalytic muffler. Continuity and momentum equations applied to AVL FIRE™ [11] are summarized as follows.

$$\frac{\partial u_i}{\partial x_i} = 0 \quad (1)$$

$$\frac{\partial}{\partial x_i} (\rho u_i u_j) = -\frac{\partial p}{\partial x_i} + \frac{\partial}{\partial x_j} \left[\mu_{eff} \left\{ \frac{\partial u_i}{\partial x_j} + \frac{\partial u_j}{\partial x_i} - \frac{2}{3} \left(\frac{\partial u_k}{\partial x_k} \right) \delta_{ij} \right\} \right] \quad (2)$$

where, δ_{ij} is Kronecher delta and valid coefficient of viscosity, μ_{eff} , means sum of the viscosity, μ and eddy viscosity, μ_t . Likewise, turbulent kinetic energy, k , and the dissipation rate, ε , have the following relation, i.e.,

$$\mu_t = \rho C_\mu \frac{k^2}{\varepsilon} \quad (3)$$

Here, the turbulence quantities, k and ε , can be obtained by using the following standard $k - \varepsilon$ [12].

Gyo Woo Lee, Associate Professor, is with the Division of Mechanical Design Engineering, Chonbuk National University, Jeonju, Chonbuk 561-756, Republic of Korea.

Man Young Kim, Corresponding Author, Professor, is with the Department of Aerospace Engineering, Chonbuk National University, Jeonju, Chonbuk 561-756, Republic of Korea (e-mail: manykim@jbnu.ac.kr).

$$\frac{\partial}{\partial x_j}(\rho u_j k) = -\frac{\partial}{\partial x_j} \left[\left(\mu + \frac{\mu_t}{\sigma_k} \right) \frac{\partial k}{\partial x_j} \right] + P - \varepsilon \quad (4)$$

and

$$\frac{\partial}{\partial x_j}(\rho u_j \varepsilon) = -\frac{\partial}{\partial x_j} \left[\left(\mu + \frac{\mu_t}{\sigma_\varepsilon} \right) \frac{\partial \varepsilon}{\partial x_j} \right] + C_{\varepsilon 1} \frac{\varepsilon}{k} P - C_{\varepsilon 2} \frac{\varepsilon^2}{k} \quad (5)$$

where P is generated when flow is transformed by stress. Likewise each coefficient is determined by general values of muffler such as Table I. In this work, substrate is considered for porous medium, and turbulent kinetic energy, k , inside the porous medium and dissipation rate, ε , to consider laminar process in the channel is calculated as follows [11].

$$\varepsilon = C_\mu^{3/4} \frac{k^{3/2}}{L_{por}} \quad (6)$$

where L_{por} is turbulent length scale which estimates the turbulent characteristics inside the porous medium. Tube-friction pressure drop model is applied to this study due to pressure drop generated by the wall friction within the porous medium, and it is calculated as follows:

$$\frac{dP}{dx} = -\frac{\lambda_{L/T}}{d_{hyd}} \frac{\rho}{2} w^2 \quad (7)$$

where λ_L is $\phi 64 / Re_d$, and λ_T is $0.316 / Re_d^{1/4}$, and it, respectively, appears the laminar and turbulent tube-friction. And shape factor, ϕ , changed with shape of the cross sections is 1, when the cross section is circle [11].

TABLE I
THE TURBULENT CONSTANTS USED IN THE $k - \varepsilon$ MODEL [12]

C_μ	$C_{\varepsilon 1}$	$C_{\varepsilon 2}$	σ_k	σ_ε
0.09	1.44	1.92	1.0	1.3

Likewise, the velocity distribution of a moving fluid from the exhaust pipe to catalytic converter affects conversion rate and durability of the catalyst. Therefore, index about this should be established. Uniformity index is to grasp homogeneous limit of the fluid at the front face of the catalyst. In this study, the formulation is described by Weltens et al. [13]

$$\gamma = 1 - \sum_{i=0}^n \frac{|u_i - \bar{u}|}{2\bar{u}S} S_i \quad (8)$$

where, n is number of cells, S is total monolith area, S_i is local cell area, u_i is local velocity, and \bar{u} is mean velocity. Uniformity index has value between 0 and 1, and if value is close at 1, the meaning is uniform velocity distribution.

B. Grid Generation

Fig. 1 shows the schematic of the catalytic muffler with perforated inlet cone, catalysts such as DOC and DPF inside the muffler, and perforated pipe at the exit part with overall dimensions. After used grids changed surface data file (*.STL) to use shapes generated for three-dimensional CAD at the commercial CFD code (AVL FIRE™), that was generated by using FAME Hybrid function [11]. Afterwards, calculation has been repeatedly conducted to gain decrease of the calculation time and valid convergence, and grid system was optimized. Total length of used model is 603.8mm, internal diameter is 198.5mm, entrance diameter is 76mm, exit diameter is 56mm, and pore, in which diameter is 10mm, at cone and exit pipe in the part of the inlet and outlet is respectively about 24, 120.

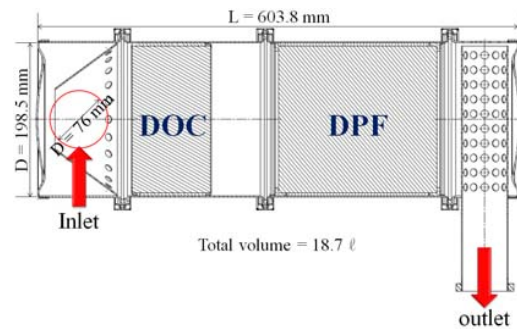

Fig. 1 Catalytic muffler adopted in this work

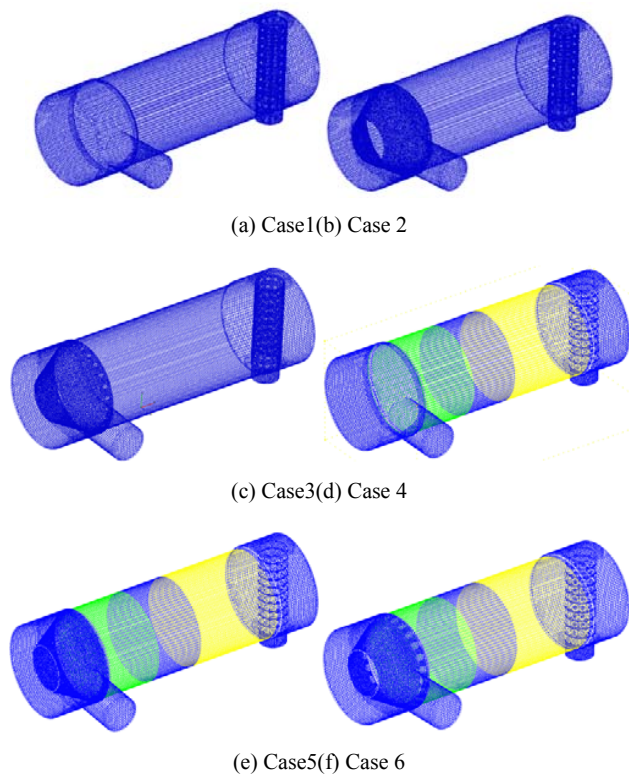

Fig. 2 Computational grid system of the catalytic muffler

C. Boundary Conditions

Table II presents boundary conditions of this work. Mass flow rate of inflowing exhaust gases are 100, 200, 300, and 400 kg/h, working fluid is air of 20°C, density and coefficient of kinematic viscosity are respectively 1.204 kg/m³, 1.51×10⁻⁵ m²/s, the surface of a wall is applied for wall function, and heat transfer effect at the surface of a wall is not considered. Outlet condition is 1 atm (atmosphere condition).

TABLE II
BOUNDARY CONDITIONS USED IN THIS STUDY

Variable	Unit	Value
Mass flow rate	kg/h	100, 200, 300, 400
Air	°C	20
Density	kg/m ³	1.204
Coefficient of kinematic viscosity	m ² /s	1.51×10 ⁻⁵
Outlet condition	atm	1

TABLE III
THE TEST CASES ADOPTED IN THIS WORK

Cases	Cone	Perforated Cone	Catalysts	Perforated Pipe
1	×	×	×	○
2	○	×	×	○
3	×	○	×	○
4	×	×	○	○
5	○	×	○	○
6	×	○	○	○

III. RESULTS AND DISCUSSION

In this work, six different types of catalytic muffler named as Cases 1 to 6 are considered as listed in Table III. They are classified in terms of inlet cone, perforated inlet cone, catalysts within the muffler, and perforated pipe at exit, respectively.

The perforated inlet cone has 24 holes evenly distributed outer part of the cone, which leads to 4.6% of porosity, while the perforated pipe at exit does 120 holes with 79.1% of porosity. The surface meshes of each Case are illustrated in Fig. 2. In order to evaluate the flow performance of the catalytic muffler, three different types of flow characteristics such as streak lines inside the catalytic muffler, flow uniformity index in front of the first catalyst DOC, and pressure drop between the inlet and outlet pipes are investigated in the following section. Here, the pressure drop is important in view of exhaust system design because this affects the vehicle fuel efficiency, while the flow uniformity index influences the conversion efficiency of the catalysts inside the muffler.

A. Model Validation

Firstly, the pressure drop values between the inlet and outlet pipes are compared with experimental ones obtained by KATECH (Korea Automotive Technology Institute) to validate the present numerical models. Fig. 3 shows pressure drop with 7 different mass flow rate values for Case 6, which has perforated inlet cone, catalysts, and perforated exit pipe. The calculated and measured pressure drop slightly increase with mass flow rates, however, those values are nearly flat ranging from 1 to 2 kPa. Also, it can be found that the present simulation values are nearly identical to those obtained from experiment.

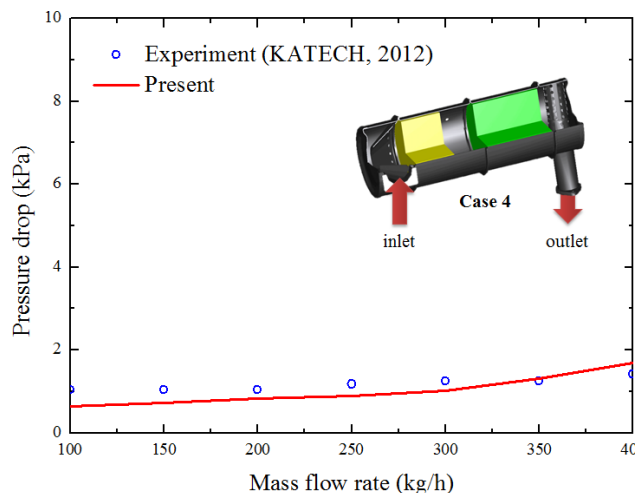
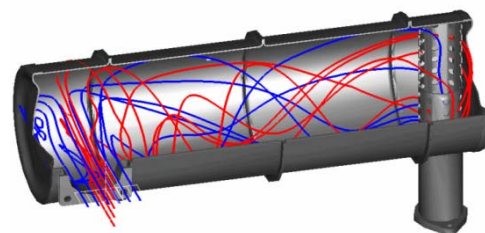

Fig. 3 Comparison of the pressure drop for the Case 4 with mass flow rate

B. Flow Distributions

Fig. 4 shows streak lines within the catalytic muffler with different inlets and catalyst configurations. If there is no catalyst, the flow is very complex and does not have uniform flow distribution. In case with catalysts, however, the flow becomes more uniform because the exhaust gases should flow through each channel within the catalysts. The longitudinal velocity contours in front of DOC and DPF are depicted in Fig. 5 for the Cases of 4 to 6. If there is no inlet cone such as Case 4, the flow is observed to be impinging to the left wall and gases mainly flow along the wall; therefore, flow is concentrated on the surface wall of the muffler. In Case 5, i.e., with inlet cone without circumferential holes, the concentrated part of the flow is moved to center region of the muffler and forms velocity gradients in the surroundings. Fig. 5(c) shows the flow pattern for Case 6 of perforated inlet cone. Here, it can be seen that the exhaust gases flow through the holes and form the velocity spikes along the side wall. Also, it is observed that the flow concentration in the center part is slightly avoided compared to Case 5 because of the side holes in the inlet cone.



(a) Case 1

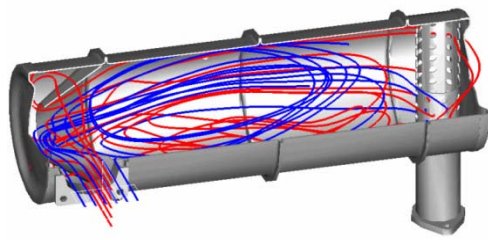

(b) Case 2

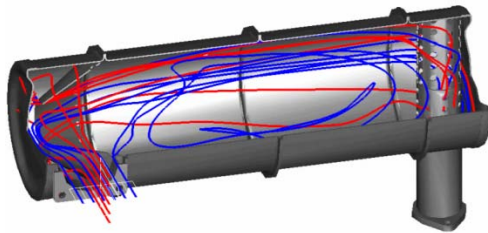

(c) Case 3

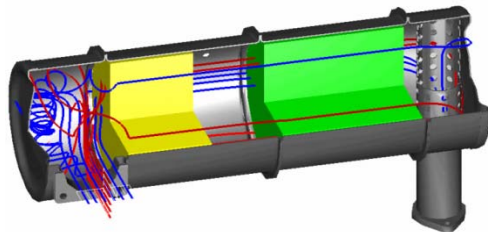

(d) Case 4

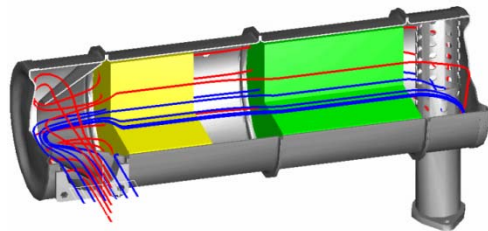

(e) Case 5

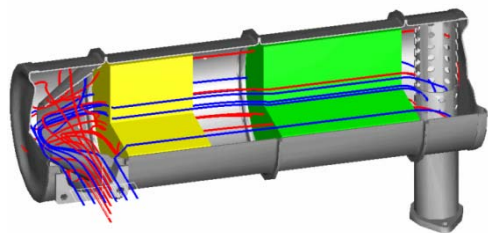

(f) Case 6

Fig. 4 Streak lines within the catalytic muffler with different inlets and different catalyst configurations

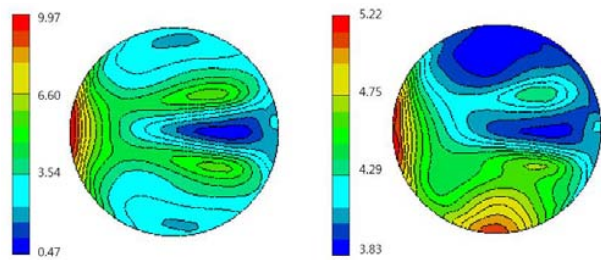

DOCDPF

(a) Case 4

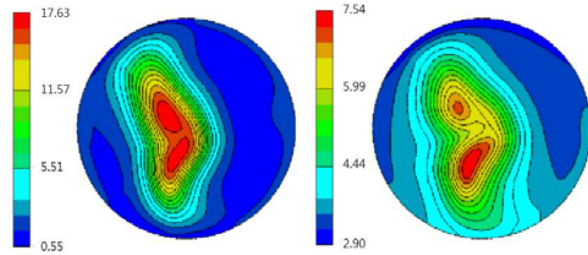

DOCDPF

(b) Case 5

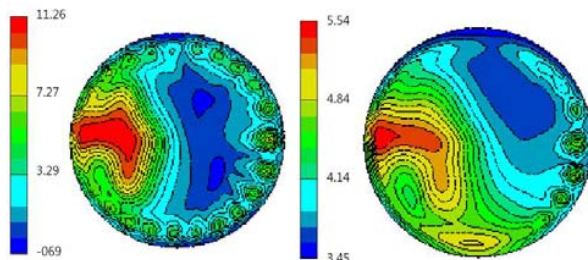

DOCDPF

(c) Case 6

Fig. 5 The longitudinal velocity contours in front of DOC and DPF, respectively, within the catalytic muffler with mass flow rate of 400kg/h for Cases 4 to 6

Fig. 6 presents the comparison of the uniformity index defined in (8) for different Cases 1 to 6 with mass flow rates of 100, 200, 300, and 400 kg/h. Since the catalysts make the flow more evenly distributed, Cases 4 to 6 show higher uniformity index than Cases 1 to 3. Although the muffler has catalysts inside it, the inlet configuration greatly affects the flow uniformity as shown in Fig. 6. Also, it can be found that the inlet cone plays a guide vane for flow uniformity while the perforated cone provides more uniform velocity distributions.

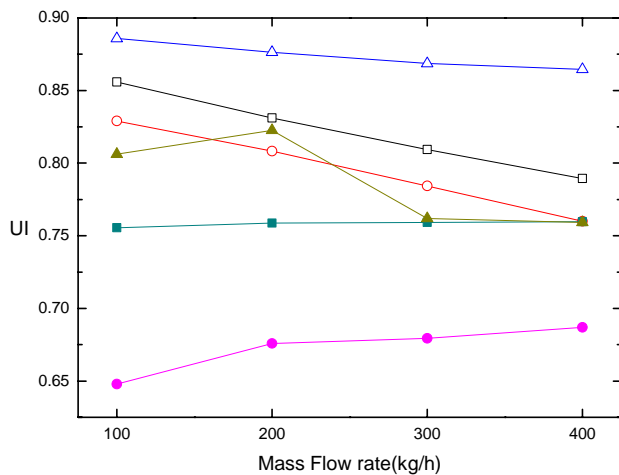

Fig. 6 Comparison of the uniformity index (UI) for the catalytic muffler with different configurations and different mass flow rates

C. Pressure Drop

The pressure drop values measured between inlet and exit pipes are depicted in Fig. 7 with four different mass flow rates. As expected, the more exhaust gases flow into the catalytic muffler, the more pressure drop occurs. Also, because the catalysts within the muffler block the flow, the pressure difference becomes larger than the cases of without catalysts.

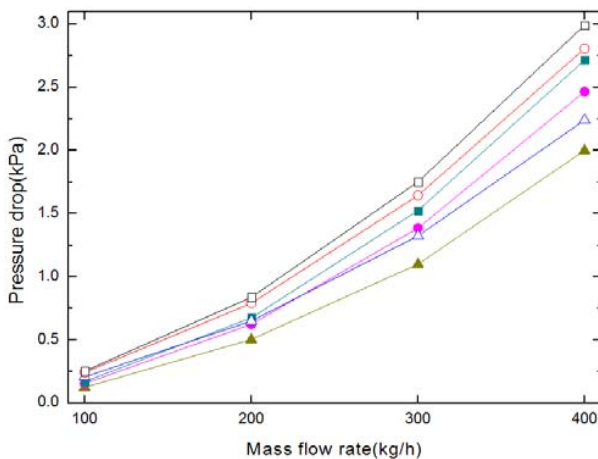

Fig. 7 Comparison of the pressure drop for the catalytic muffler with different configurations and different mass flow rates

IV. CONCLUSION

In this work a mathematical model for analysis of flow in a catalytic muffler with DOC and DPF has been developed and applied for the analysis of pressure drop and flow uniformity within the catalytic muffler. The following conclusion can be drawn from this work.

- (1) The flow is more uniform in Cases 4 to 6 than others because the exhaust gases should flow through the channels of the catalysts.
- (2) Among the real cases of 4 to 6, which have catalysts inside the muffler, the perforated inlet cone makes the flow more

uniform than others, thus, that can arise higher catalyst efficiency.

- (3) Since the inserted catalysts hinder the flow, more pressure drop is measured in cases 4 to 6. Also, the perforated cone blocks more flow and induces more pressure drop than other inlet configurations.

ACKNOWLEDGMENT

This research was supported by the CEFV (Center for Environmentally Friendly Vehicle) as Global-Top Project of KMOE (Ministry of Environment, Korea). Also, this work was partially supported by the Basic Science Research Program through the National Research Foundation of Korea (NRF) funded by the Ministry of Education, Science and Technology (grant number 2011-0022179).

REFERENCES

- [1] M. Y. Kim, "Performance Prediction of SCR-DeNO_x System for Reduction of Diesel Engine NO_x Emission", *Transactions of the KSAE*, Vol. 11/2003, pp. 71-76.
- [2] J. H. Kim, M. Y. Kim, and H. G. Kim, "NO₂-Assisted Soot Regeneration Behavior in a Diesel Particulate Filter with Heavy-Duty Diesel Exhaust Gases", *Numerical Heat Transfer, Part A*, Vol. 58, 2010, pp. 725-739
- [3] S. Y. Lee, K. N. Kang, M. Y. Kim, and C. H. Lee; "A Numerical Study on the Urea Melting and Heat Transfer Characteristics with Three Different Types of Coolant Heaters", *Proceedings of the KSAE Annual Conference*; pp. 582-588; Daejeon, 2011. 11. 23-26.
- [4] X. Zhang and P. Tennison, "Numerical Study of Flow Uniformity and Pressure Loss through a Catalytic Converter with Two Substrates"; SAE 2008-01-0614; 2008.
- [5] Y. D. Kim, S. J. Jeong, and W. S. Kim, "An Numerical Study on the Flow Uniformity and Pressure Drop in Dual Monolith Catalytic Converter during the Rapid Acceleration/Deceleration Driving", *Transactions of the KSAE*, Vol. 15, 2007, pp. 63-71.
- [6] X. Zhang, M. Romzek, M. Keck, and F. Kurz, "Numerical Optimization of Flow Uniformity inside Diesel Particular Filters", SAE 2005-01-3702, 2005.
- [7] J. Y. Kim and S. H. Son, "Improving Flow Efficiency of a Catalytic Converter Using the Concept of Radially Variable Cell Density - Part I", SAE 1999-01-0769; 1999
- [8] S. Y. Lee, S. S. Park, H. Y. Kim, and K. M. Cho, "Flow Analysis of CCC with the Change of Cell Shape", *Transactions of the KSAE*, Vol. 6, 1998, pp. 72-77.
- [9] S. F. Benjamin, C. A. Roberts, and J. Wollin, "A Study of the Effect of Flow Pulsations on the Flow Distribution within Ceramic Contoured Catalyst Substrates", SAE 2001-01-1996; 2001.
- [10] K. N. Kang, M. S. Jung, C. M. Kim, J. K. Lee, and M. Y. Kim, "Numerical Study on the Mixing Flow Characteristics with a Vane-Type Static Mixer in a Diesel Exhaust System for Urea SCR Application", *Proceedings of the KSAE Spring Conference*, pp. 532-538, Jeju, 2011. 5. 19-21.
- [11] AVL Fire™, "Boost-Aftertreatment-CFD-Solver", pp.254-255, 2010.
- [12] B. E. Launder and D. B. Spalding, "The Numerical Computation of Turbulent Flows", *Computer Methods in Applied Mechanics and Engineering*, Vol. 3, 1974, pp. 269-289.
- [13] H. Weltens, H. Bressler, F. Terres, H. Neumaier, and D. Rammoser, "Optimization of Catalytic Converter Gas Flow Distribution by CFD Predictions", SAE 930780; 1993.