

# A Comprehensive model for developing of Steer-By-Wire System

Reza Kazemi , Iman Mousavinejad

**Abstract** –Steer-By-Wire ( SBW ) has several advantages of packaging flexibility , advanced vehicle control system ,and superior performance . SBW has no mechanical linkage between the steering gear and the steering column. It is possible to control the steering wheel and the front-wheel steering independently. SBW system is composed of two motors controlled by ECU. One motor in the steering wheel is to improve the driver's steering feel and the other motor in the steering linkage is to improve the vehicle maneuverability and stability. This paper shows a new approach at modeling of SBW system by Bond Graph theory. The mechanical parts , the steering wheel motor and the front wheel motor will be modeled by this theory. The work in the paper will help to guide further researches on control algorithm of the SBW system .

**Keywords** – Steer-By-Wire ( SBW ) , Bond Graph theory , Electronic-Control-Unit ( ECU ) , Modeling .

## I. INTRODUCTION

An SBW system is one part of the Drive-By-Wire (DBW) system that the automotive industry will research in future .

The new DBW system will replace mechanical and hydraulic systems for steering , braking , suspension and throttle functions with electronic actuators , controllers and sensors . An SBW system is one in which the conventional linkage between the steering wheel and the front wheel are removed and its operated by electronic actuators. The SBW system has many advantages because it can easily eliminate the interference between the driver and the steering system :

- Increased packaging flexibility
- Simplified assembly
- Reduced mass
- Advanced vehicle control systems and superior performance .

The SBW system can reduce a vehicle's weight by reducing the number of necessary parts which can lead to energy reduction effectiveness.

A special advantage is also increased without mechanical linkage In addition, the danger of a driver being crushed when there is a front-end collision is eliminated as there is no steering column. Also , it is suited to active front steering control , improving vehicle stability , dynamics and maneuverability . [1, 2]

R.Kazemi is associate professor in mechanical engineering faculty of K.N.Toosi university of technology . No.15,Pardis St. Mollasadra Ave , Vanak Sq, Tehran,Iran. P.o.Box : 19395-1999, [Tel:88674747](tel:88674747) (+9821), Fax:88674748(+9821). Email: kazemi@kntu.ac.ir

I.Mousavinejad is graduate student ( M.sc degree ) in Sharif university of technology-International campus-Kish island, Iran , [Tel:22299665](tel:22299665) (+9821) Email: iman.mousavinejad@gmail.com

For this reason , the study of the SBW system has proceeded . **T.Park** et al, 2003, worked at the electronic control unit for the rack-actuating steer-by-wire using the hardware in the loop simulation system [3] . The bond graph theory was used in this research to model the steer-by-wire system. **S.H.Jang** et al ,2003, proposed the method to control the steer-by-wire system. The bond graph theory was used to model the front wheel motor [1].

## II. SBW MODELING

The SBW system has three subsystems :

1. Steering wheel subsystem
2. Front wheel subsystem
3. Electronic control unit ( ECU )

The first subsystem , steering wheel subsystem , contains torque sensor , steering angle sensor and steering wheel motor. The steering wheel motor provides torque feedback to the driver to feel in relation to the position of the steering wheel and the motion of the vehicle .

The second subsystem , front wheel subsystem , contains position sensor , rack pinion gear , other mechanical mechanisms , and front wheel motor. The front wheel motor positions the tire according to inputting data provided by the driver via steering wheel subsystem.

The Electronic Control Unit ( ECU ) controls the steering wheel motor and the front wheel motor for the driver's steering feel and for improving vehicle maneuverability and stability. [4 , 5]

To model the steering wheel subsystem and the front wheel subsystem , the bond graph theory is used. Bond Graph is one of the modeling tools which is used to model the complex multi-energy engineering systems including mechanical , electrical , hydraulic subsystems and etc . It consists of the following types of elements :

C , I , R elements , which are passive one-port elements that contain no sources of power , and includes compliances , inductances and resistances respectively .

Power source elements including  $S_e$  ,  $S_f$  which are active one-port elements represent sources of effort or flow , respectively .

Transformer ( TF ) and gyrator ( GY ) , which are two-port elements , represent transformer and gyrators , respectively. Power is conserved in these elements .

Function 0 , 1 , which are multi-port elements represent series and parallel relations among elements ( common effort or common flow ) , serve to interconnect elements into subsystem or system models .[6]

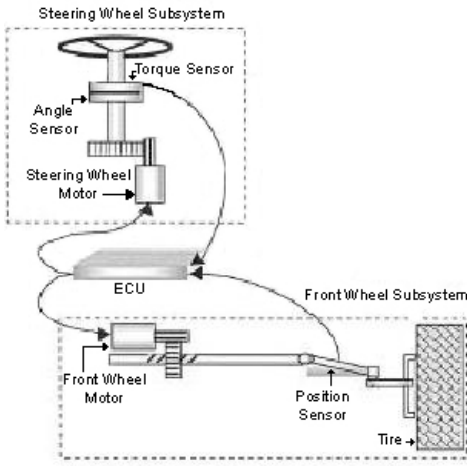

Fig.1 Steer-By-Wire Set up [8]

a. STEERING WHEEL SUBSYSTEM MODELING

ECU generates input signals to control the reactive torque of the steering wheel motor by considering the data coming from the sensors monitoring steering wheel angle and steering column torque. The steering wheel, the steering wheel motor, gear mechanism and steering wheel column are modeled by using the bond graph theory.

The elements are considered as follows :

Variable	Definition
$V_s$	The voltage of the steering wheel motor
$R_{sa}$	The steering wheel motor resistance
$L_{sa}$	The steering wheel motor inductance
$K_{sb}$	The steering wheel motor torque constant
$J_{sm}$	The steering wheel motor moment of inertia
$B_{sm}$	The steering wheel motor resistance coefficient
$C_{sm}$	The compliance of the steering wheel motor shaft
$G$	The reduction ratio of gear mechanism
$J_{sw}$	The steering wheel and steering column moment of inertia
$B_{sw}$	The resistance at the steering column
$C_{sw}$	The compliance of the steering column
$T_d$	The driver's torque acting on the steering wheel

Table 1. The elements of the steering wheel subsystem

Fig.2 shows the mechatronics diagram of the steering wheel subsystem and Fig.3 shows the bong graph modeling of the steering wheel subsystem .

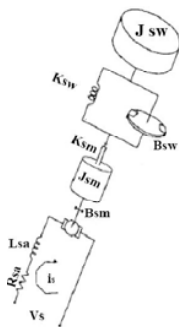

Fig.2 mechatronics diagram of the steering wheel subsystem

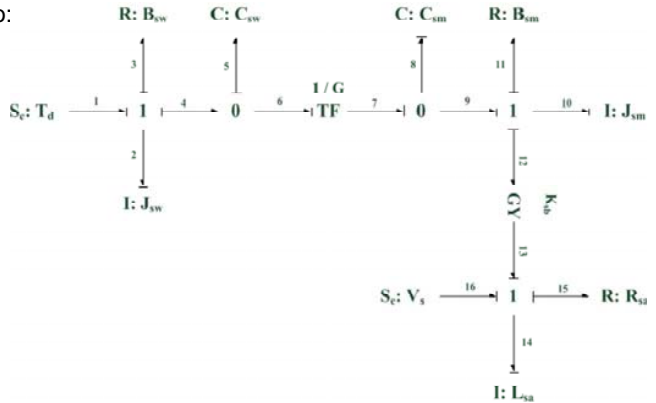

Fig.3 Bond graph modeling of the steering wheel subsystem

The state equations of the steering wheel subsystem are established by using the bond graph shown in Fig.3. Therefore the equations are written as follows :

Equation for the driver's torque acting on the steering wheel:

$$\dot{p}_2 = -\frac{B_{sw}}{J_{sw}}p_2 - \frac{1}{C_s}q_5 + T_d$$

Equation for the angular velocity at the steering column:

$$\dot{q}_5 = \frac{-GC_{sw}}{J_{sm}(C_{sw}+C_{sm}G^2)}p_{10} + \frac{C_{sw}}{J_{sw}(C_{sw}+C_{sm}G^2)}p_2$$

Equation for the torque at the shaft of the steering wheel motor before considering the compliance of the shaft ( $C_{sm}$ ):

$$\dot{p}_{10} = -\frac{K_{sa}}{L_{sa}}p_{14} - \frac{B_{sm}}{J_{sm}}p_{10} + \frac{G}{C_{sw}}q_5$$

Equation for voltage of the steering wheel motor at the inductance:

$$\dot{p}_{14} = V_s - \frac{R_{sa}}{L_{sa}}p_{14} + \frac{K_{sb}}{J_{sm}}p_{11}$$

Equation for angle of the steering column:

$$\delta_s = \frac{1}{J_{sw}}p_2$$

Consequently the state equations of the steering wheel subsystem are given below:

$$\begin{aligned} \dot{X}(t) &= A_s X(t) + B_s u(t) \\ y(t) &= C_s X(t) + D_s u(t) \end{aligned}$$

Where the state vector is expressed as :

$$X = [p_{14} \ p_{10} \ p_2 \ q_5]^T$$

The voltage supplied to the steering wheel motor and the applied driver torque are considered as the input of the steering wheel subsystem such as the following ,

$$u = [V_s \ T_d]^T$$

$$A_s = \begin{bmatrix} \frac{-R_{sa}}{L_{sa}} & \frac{K_{sb}}{J_{sm}} & 0 & 0 \\ \frac{-K_{sb}}{L_{sa}} & \frac{-B_{sm}}{J_{sm}} & 0 & \frac{G}{C_{sw}} \\ 0 & 0 & \frac{-B_{sw}}{J_{sw}} & \frac{-1}{C_{sw}} \\ 0 & \frac{-GC_{sw}}{J_{sm}(C_{sw}+G_{sm}G^2)} & \frac{C_{sw}}{J_{sw}(C_{sw}+C_{sm}G^2)} & 0 \end{bmatrix}$$

$$B_s = \begin{bmatrix} 1 & 0 & 0 & 0 \\ 0 & 0 & 1 & 0 \end{bmatrix}^T$$

$$C_s = [0 \quad 0 \quad 1/J_{sw} \quad 0]$$

$$D_s = 0$$

$$y = \delta_s$$

b. FRONT WHEEL SUBSYSTEM MODELING

ECU generates the input signals to control the torque of the front wheel motor by considering the information obtained from the position sensor monitoring rack bar displacement and integrating it with other information. The front wheel motor , rack and pinion , tie rod and tire are modeled by using the bond graph theory .

The elements are considered as follows :

Variable	Definition
$V_w$	The voltage of the front wheel motor
$R_{wa}$	The front wheel motor resistance
$L_{wa}$	The front wheel motor inductance
$K_{wb}$	The front wheel motor torque constant
$J_{wm}$	The front wheel motor moment of inertia
$B_{wm}$	The front wheel motor resistance coefficient
$C_{wm}$	The compliance of the front wheel motor shaft
$G_{mr}$	The radius of the pinion
$M$	The mass of the rack
$B_r$	The resistance of the rack
$C_{tr}$	The compliance of the tie rod
$B_t$	The resistance of the tie rod
$J_t$	The inertia of the tire
$T_a$	The self-aligning torque
$G_r$	The length ratio of the steering arm

Table 2. The elements of the front wheel subsystem

Fig.4 shows the mechatronics diagram of the front wheel subsystem and Fig.5 shows the bond graph of it .

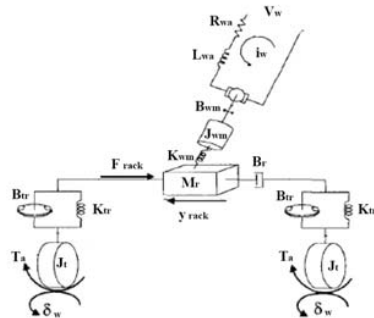

Fig.4 The mechatronics diagram of the front wheel subsystem

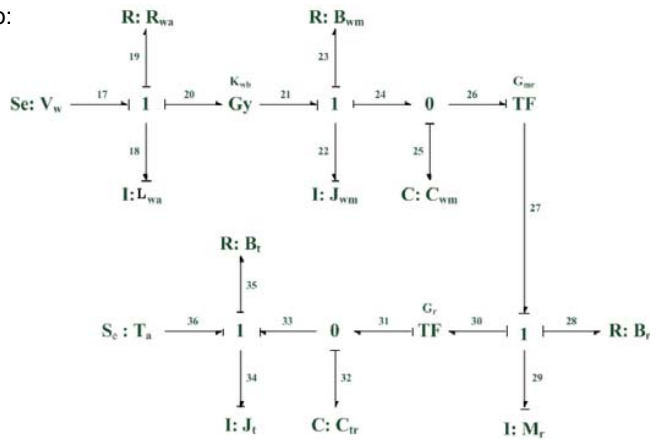

Fig.5 The bond graph of the front wheel subsystem

The state equations of the front wheel subsystem are established using the bond graph shown in Fig.5. Therefore the state equations are written as follows:

Equation for voltage of the front wheel motor at the inductance:

$$\dot{p}_{18} = -\frac{R_{wa}}{L_{wa}} p_{18} - \frac{K_{wb}}{J_{wm}} p_{22} + V_w$$

Equation for the torque at the shaft of the front wheel motor before considering the compliance of the shaft ( $C_{wm}$ ):

$$\dot{p}_{22} = \frac{K_{wb}}{L_{wa}} p_{18} - \frac{B_{wm}}{J_{wm}} p_{22} - \frac{1}{C_{wm}} q_{25}$$

Equation for the angular velocity of the output shaft of the front wheel motor:

$$\dot{q}_{25} = \frac{1}{J_{wm}} p_{22} - \frac{1}{G_{mr}M_r} p_{29}$$

Equation for the force acting on the rack:

$$\dot{p}_{29} = -\frac{B_r}{M_r} p_{29} + \frac{1}{G_{mr}C_{wm}} q_{25} - \frac{G_r}{C_{tr}} q_{32}$$

Equation for the linear velocity of the tie rod:

$$\dot{q}_{32} = \frac{1}{G_rM_r} p_{29} - \frac{1}{J_t} p_{34}$$

Equation for the torque acting on the tire:

$$\dot{p}_{34} = -\frac{B_t}{J_t} p_{34} + \frac{1}{C_{tr}} q_{32} + T_a$$

Equation for angle of the front wheel:

$$\delta_w = \frac{1}{J_t} p_{34}$$

Consequently the state equations of the front wheel subsystem are given below:

$$\dot{X}(t) = A_w X(t) + B_w u(t)$$

$$y(t) = C_w X(t) + D_w u(t)$$

Where the state vector is expressed as :

$$X = [p_{18} \quad p_{22} \quad p_{29} \quad p_{34} \quad q_{25} \quad q_{32}]^T$$

The voltage supplied to the front wheel motor and the torque offered by the road are considered as the input of the front wheel subsystem such as the following ,

$$u = [V_w \ T_a]^T$$

$$A_w = \begin{bmatrix} \frac{-R_{wa}}{L_{wa}} & \frac{-K_{wb}}{J_{wm}} & 0 & 0 & 0 & 0 \\ \frac{K_{wb}}{L_{wa}} & \frac{-B_{wm}}{J_{wm}} & 0 & 0 & \frac{-1}{C_{wm}} & 0 \\ 0 & 0 & \frac{-B_r}{M_r} & 0 & \frac{-1}{G_{mr}C_{wm}} & \frac{-G_r}{C_{tr}} \\ 0 & 0 & 0 & \frac{-B_t}{J_t} & 0 & \frac{1}{C_{tr}} \\ 0 & \frac{1}{J_{wm}} & \frac{-1}{G_{mr}M_r} & 0 & 0 & 0 \\ 0 & 0 & \frac{1}{G_rM_r} & \frac{-1}{J_t} & 0 & 0 \end{bmatrix}$$

$$B_w = \begin{bmatrix} 1 & 0 & 0 & 0 & 0 & 0 \\ 0 & 0 & 0 & 1 & 0 & 0 \end{bmatrix}^T$$

$$C_w = [0 \ 0 \ 0 \ 1/J_t \ 0 \ 0]$$

$$D_w = 0$$

$$y = \delta_w$$

### III. SIMULATION RESULTS

The steering wheel motor and front wheel motor are controlled by ECU because the driver's steering feel should be improved by creating the reactive torque and the maneuverability and stability of the vehicle should be improved by steering the front wheel appropriately.

In this research the eight-degree-freedom model is used to model the vehicle dynamics . In this model , the longitudinal motion , the lateral motion , the yaw motion , the roll motion and the motion of the four wheels are considered.[7]

The PACEJKA tire model with combined longitudinal and lateral slip is used to model the tire.[7]

All of these models and the model of the steering wheel motor controller and front wheel motor controller are in ref.[7].

The ISO-Lane-Change maneuver in the dry road (  $\mu =0.8$  ) is used to simulate. The initial speed of the vehicle is 100 Km/h.

Figures from Fig.6 to Fig.20 show the other results of this simulation. The parameter values of the SBW system variable are listed in Table 1 .

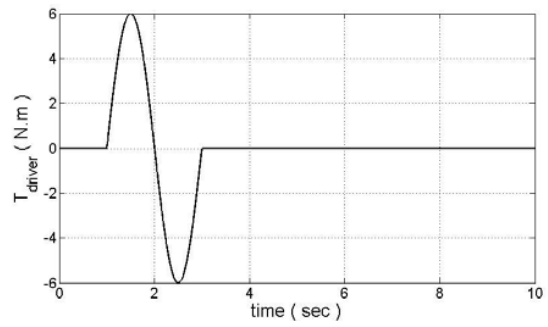

Fig.6 The driver's torque

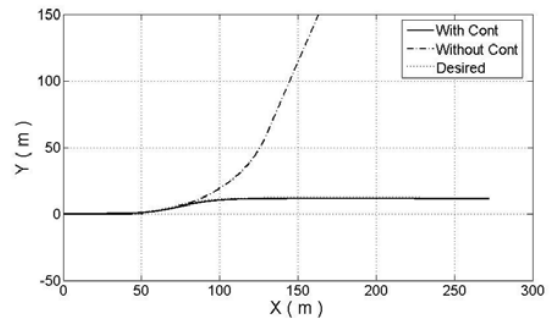

Fig.7 The track of the vehicle

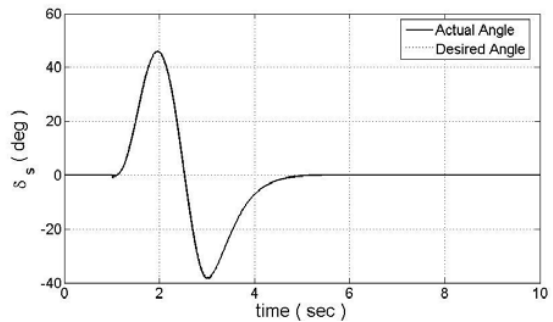

Fig.8 The angle of steering wheel

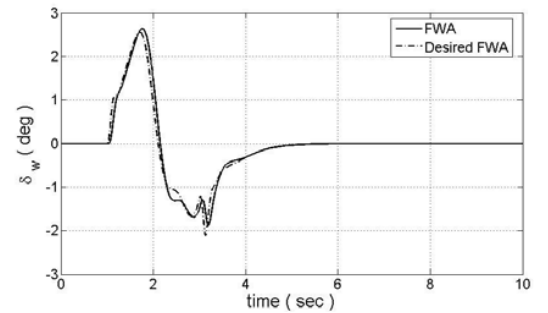

Fig.9 The angle of front wheels

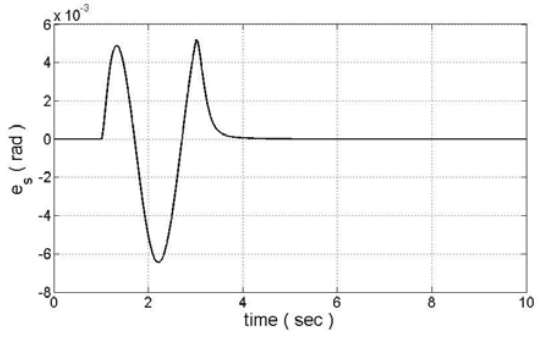

Fig.10 The error of the steering wheel motor controller

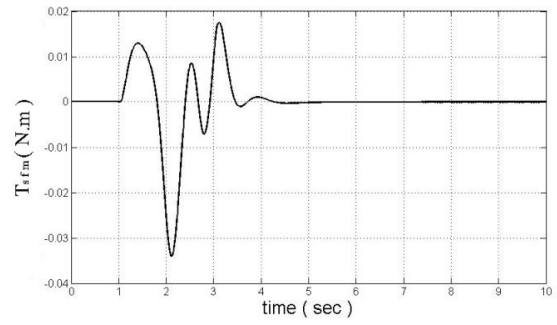

Fig.14 Torque at the shaft of the front wheel motor

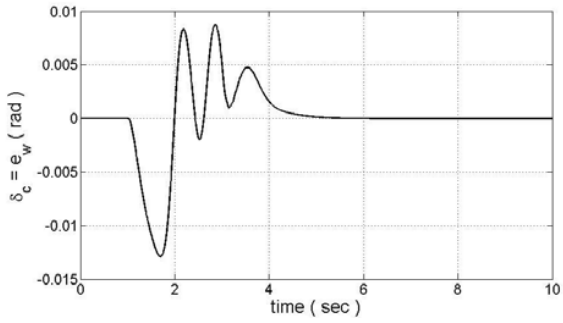

Fig.11 The error of the front wheel motor controller

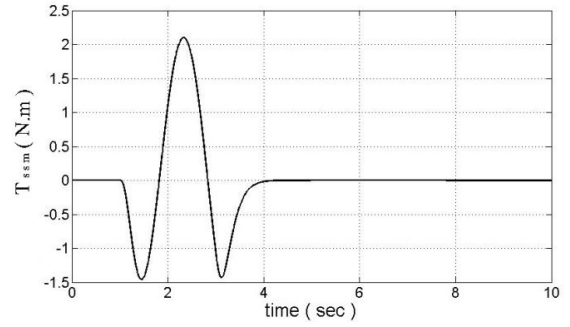

Fig.15 Torque at the shaft of the Steering wheel motor

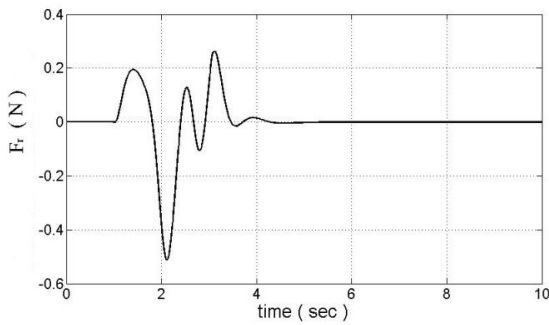

Fig.12 Force acting on the rack

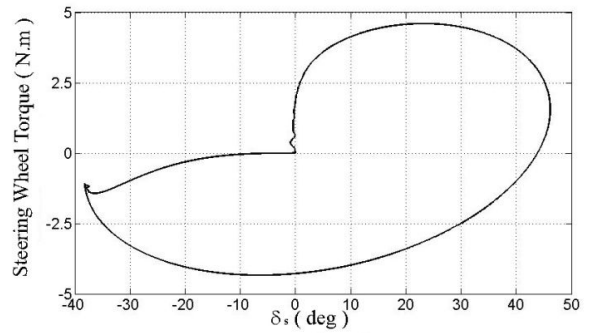

Fig.16 Driver's Steering feel Torque

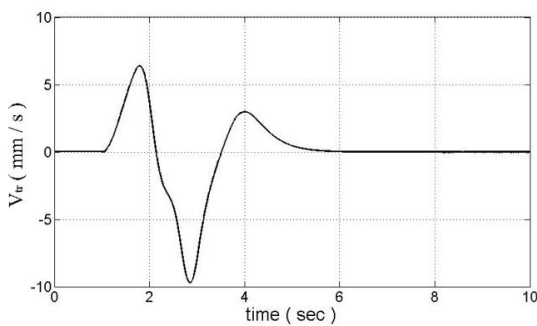

Fig.13 Linear Velocity of the tie rod

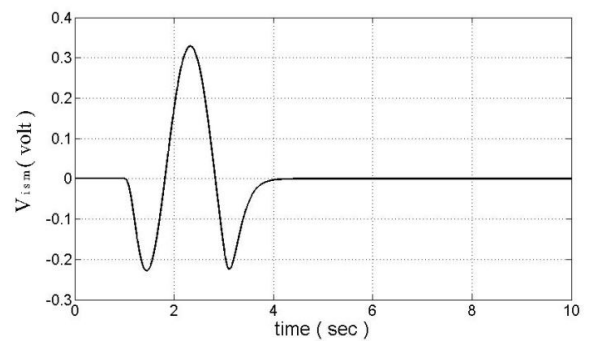

Fig.17 Voltage of the steering wheel motor at the inductance

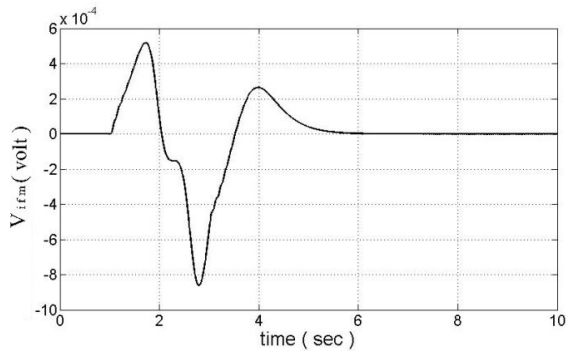

Fig.18 Voltage of the front wheel motor at the inductance

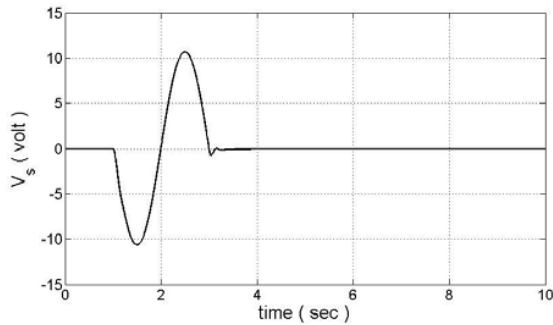

Fig.19 Maximum Voltage of the steering wheel motor

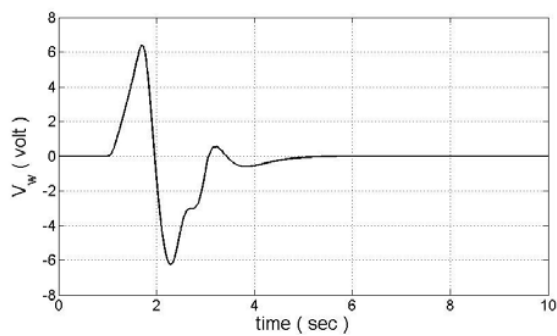

Fig.20 Maximum voltage of the front wheel motor

#### IV. CONCLUSION

In this paper, the bond graph method is used to model the steering wheel subsystem and the front wheel subsystem. As described, the bond graph theory shows transfer of energy towards the system's elements. Therefore this theory is very useful to model the complex-engineering systems. The steering wheel subsystem and the front wheel subsystem are mechatronics systems, which include the electrical and mechanical elements. The simulation results show that the steering wheel motor generates the reactive torque and the front wheel motor provides an appropriate angle of the front wheel for the driver's steering torque. The work presented is significant for further researches on control algorithm of the SBW system.

The parameter value

Parameters	Symbols	Values & Units
The mass of the vehicle	m	1300 Kg
Vehicle moment of inertia about z-axis	$I_{zz}$	1808.8 Kg.m <sup>2</sup>
Distance from the vehicle CG to the front axle	$L_f$	1.2247 m
Distance from the vehicle CG to the rear axle	$L_r$	1.4373 m
Steering wheel Moment of inertia	$J_{sw}$	0.04 Kg.m <sup>2</sup>
Resistance at steering column	$B_{sw}$	0.225 Nm/(rad/s)
Compliance of the steering column	$C_{sw}$	5.8*10 <sup>-3</sup> rad/(N.m)
Steering wheel motor moment of inertia	$J_{sm}$	4.8*10 <sup>-4</sup> Kg.m <sup>2</sup>
Steering wheel motor resistance coefficient	$B_{sm}$	3.4*10 <sup>-3</sup> N/(m/s)
Compliance of steering wheel motor shaft	$C_{sm}$	1.59*10 <sup>-3</sup> rad/s/(N.m)
Steering wheel motor resistance	$R_{sa}$	0.1685 ohm
Steering wheel motor inductance	$L_{sa}$	2.69*10 <sup>-4</sup> Henry
Steering wheel motor torque constant	$K_{sb}$	0.045 Nm/A; V/(rad/s)
Gear mechanism reduction ratio	G	0.49
Steering column pinion radius	$G_{mr}$	7.367*10 <sup>-3</sup> m
Length ratio of the steering arm	$G_r$	1
Mass of the rack	$M_r$	2 Kg
Resistance at the rack	$B_r$	90 N.m/(rad/s)
Front wheel motor resistance	$R_{wa}$	0.21 ohm
Front wheel motor inductance	$L_{wa}$	0.52*10 <sup>-3</sup> Henry
Front wheel motor torque constant	$K_{wb}$	0.65 Nm/A ; V/(rad/s)
Front wheel motor moment of inertia	$J_{wm}$	9.8*10 <sup>-4</sup> Kg.m <sup>2</sup>
Front wheel motor resistance coefficient	$B_{wm}$	5.7*10 <sup>-4</sup> N/(m/s)
Compliance of front wheel motor shaft	$C_{wm}$	1.29*10 <sup>-3</sup> rad/s/(N.m)
Compliance of the tie rod	$C_{tr}$	6.72*10 <sup>-5</sup> rad/N.m
Resistance of the tie rod	$B_t$	40 N.m/(rad/s)
Inertia of the tire	$J_t$	1.8 Kg.m <sup>2</sup>

- [1]. S.Jang et al, "A control of vehicle using steer-by-wire system with hardware-in-the-loop-simulation system" , 2003 *IEEE / ASME*
- [2]. M.A.Chadwik et al, "Nonlinear Identification of a Steer-By-Wire system", University of Sheffield.
- [3]. T.Park et al, " Development of the electronic control unit for the rack-actuating steer-by-wire using the hardware-in-the-loop simulation system ", 2005 , *MECHATRONICS Journal*, pp 899-918
- [4]. T.Kaufmann et al , "Development experience with steer-by-wire," *SAE paper* 2001-01-2479.
- [5]. N.Bajcinca et al, "Robust control for Steer-By-Wire Vehicles", 2005 *Springer Science*.
- [6]. C.Karnopp , *System Dynamics-Modeling and Simulation of Mechatronic Systems*. Forth edition. CA : WILEY. 2006 . pp.34-76
- [7]. I.Mousavinejad , *Nonlinear Controller Design for Steer-By-Wire Passenger car* , MS.c Thesis .2009
- [8]. E.Chou , *Steer By Wire system-Hardware in loop simulation* , BS.c Thesis.2002