

# Contribution to the Study and Optimal Exploitation of a Solar Power System for a Semi-Arid Zone (Case Study: Ferkene, Algeria)

D. Dib, W. Guebabi, M. B. Guesmi

**Abstract**—The objective of this paper is a contribution to a study of power supply by solar energy system called a common Ferkène north of Algerian desert in the semi-arid area. The optimal exploitation of the system, goes through stages of study and essential design, the choice of the model of the photovoltaic panel, the study of behavior with all the parameters involved in simulation before fixing the trajectory tracking the maximum point the power to extract (MPPT), form the essential platform to shape the design of the solar system set up to supply the town Ferkène without considering the grid. The identification of the common Ferkène by the collection of geographical, meteorological, demographic and electrical provides a basis uniform and important data. The results reflect a valid fictive model for any attempt to study and design a solar system to supply an arid or semi-arid zone by electrical energy from photovoltaic panels.

**Keywords**—Solar power, photovoltaic panel, Boost converter, supply, design, electric power, Ferkène, Algeria.

## I. INTRODUCTION

THE renewable energy provides an opportunity to produce clean electricity and especially in a low dependence on fossil resources. Photovoltaic technology is an attractive solution as a replacement or supplement conventional sources of electricity supply due to many advantages. The operation and development of the use of solar energy in Algeria are favored because of its important geographical location, especially for the Saharan regions, semi-arid and isolated areas, where the infrastructure for the distribution of electrical energy is not very developed. Indeed, given the importance of the intensity of radiation received and the duration of sunshine that exceeds ten hours a day for several months, our country can easily cover some of its power needs through solar energy.

The purpose of this work is to supply a town of a population average solar PV, after completing all the necessary steps such as modeling of suitable solar panel on the technical and economic terms, the size of the system storage control and the MPPT control and collection of the metrological, geographic, demographic and electrical data area in question.

The area of Ferkene in this study is in Negrine town into Tebessa city and is considered the best to take it as a case of application in a semi-arid area of Algeria.

D. Dib is with the department of Electrical Engineering, University of Tebessa, Algeria (phone: +213 664875785, fax: +213 37490268, e-mail: dibdjalel@gmail.com).

W. Guebabi and M. B. Guesmi are with the Department of Electrical Engineering, University of Tebessa, Algeria (e-mail: w.guebabi@gmail.com, Gsmi.mb@gmail.com).

All photovoltaic systems can be composed of three parts:

- A part of energy production;
- A portion of control and regulation of the energy;
- A portion of storage and use of energy.

## II. MODELING OF THE SOLAR CELL

In the literature, several studies have been developed on the model of the solar cell and solar panel which include five models that combine both the number of diodes and series resistors and shunt characterizing solar and photovoltaic effects of the circuit. We present the most widely used and translated in a very satisfactory so as the industrial product most commercialized in the world, namely, that a single diode and two resistors [1], [3].

Thereafter we simulate this model where the change in temperature, solar radiation, and the series resistance represent the main part of this paper.

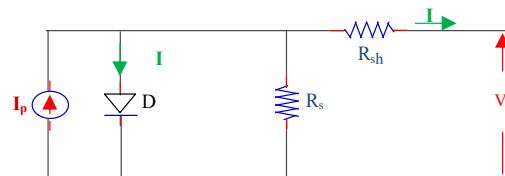

Fig. 1 Equivalent model (one diode + two resistors) of a photovoltaic cell [4]

$$I = \left( I_{ph} - I_{sat} \left[ e^{\frac{q(V+I \cdot R_{sh})}{AKTc}} - 1 \right] - \left( \frac{V+I \cdot R_{sh}}{R_s} \right) \right) \quad (1)$$

$I$  and  $V$  are the current and the output voltage of the photovoltaic cell,

$I_{ph}$  is the photocurrent produced,

$I_{sat}$  is the saturation current,

$R_s$  et  $R_{sh}$  are respectively the serial resistor and shunt resistor

$T_c$  is the absolute temperature,

$A$  is the sensitivity coefficient of voltage to temperature,

$K$  is the sensitivity coefficient of the current to temperature.

## III. INFLUENCE OF VARIOUS PARAMETERS OF SOLAR CELL

The characteristics of a PV panel represent the variation of current and power panel with the voltage of the output circuit of PV in different conditions of solar radiation and medium temperature and this for the status of short circuit ( $0, I_{sc}$ ) and open circuit ( $V_o, 0$ ) [11], [12].

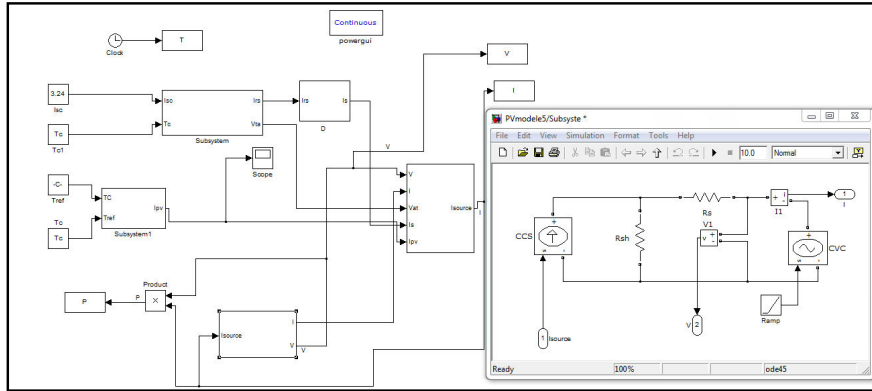
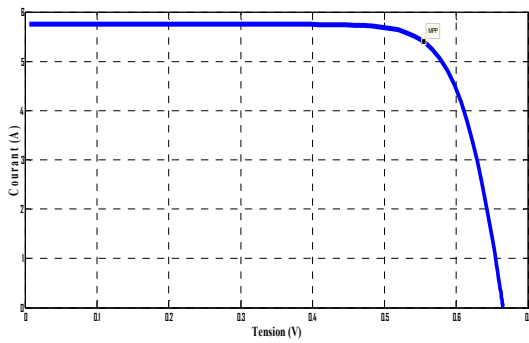
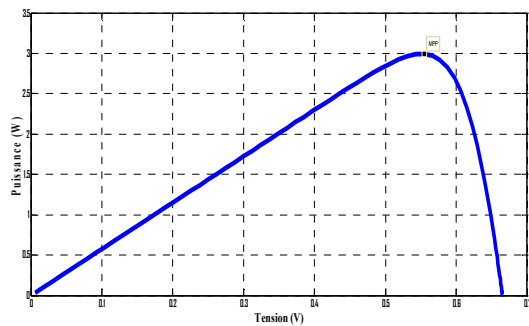

Fig. 2 Simulation block of the photovoltaic panel



(a)



(b)

Fig. 3 Variation with voltage at a fixed solar radiation and temperature: (a) Current, (b) Power

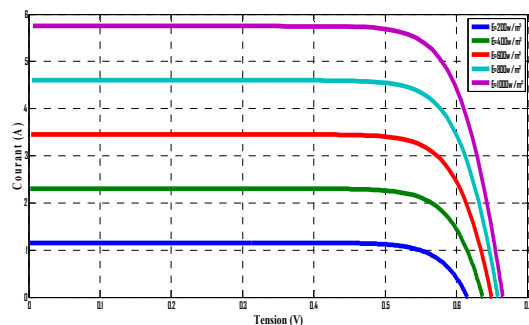

Fig. 4 Current variation with voltage at variable solar irradiance

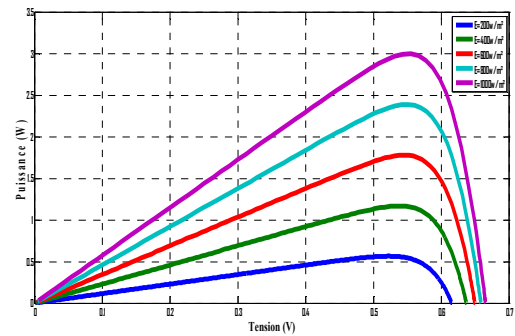

Fig. 5 Power variation with voltage at variable solar irradiance and fixed temperature

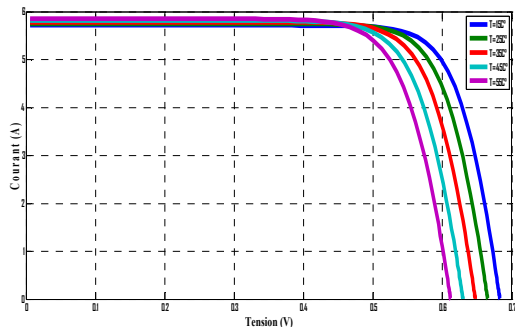

Fig. 6 Current variation with voltage at variable temperature

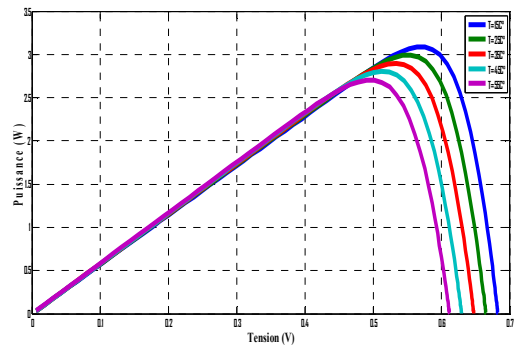
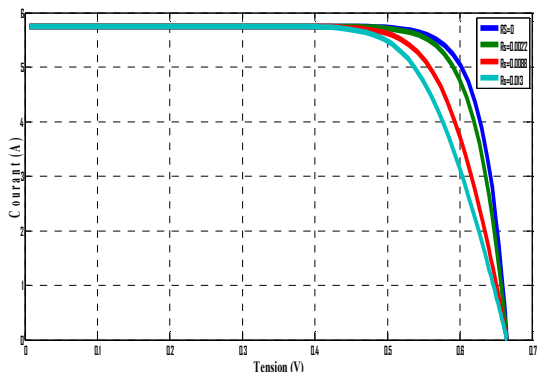
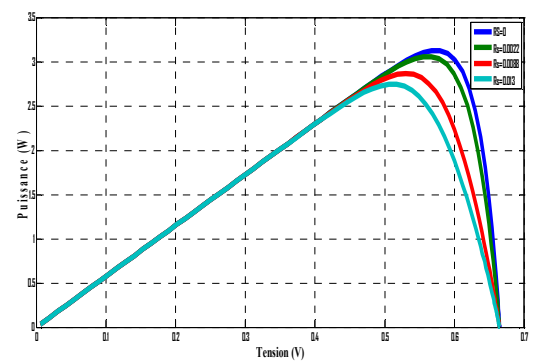

Fig. 7 Power variation with voltage at variable solar Temperature



(a)



(b)

Fig. 8 Variation with voltage at variable serial resistor: (a) Current, (b) Power

IV. IN SEARCH OF THE MAXIMUM POWER POINT TRACKING, MPPT

With changes in weather conditions, a control device must be integrated into the control circuit of the converter (DC / DC), as is shown in (Fig. 10). It must be able to operate the photovoltaic generator at its maximum power with the instability of conditions. This type of control is often called "Searching for Maximum Power Point" or "Maximum Power Point Tracking" (MPPT). The cell or photovoltaic panel has a maximum power point (MPP), which varies depending on sunlight and temperature and will be the target of the MPPT control analog or digital mode [7].

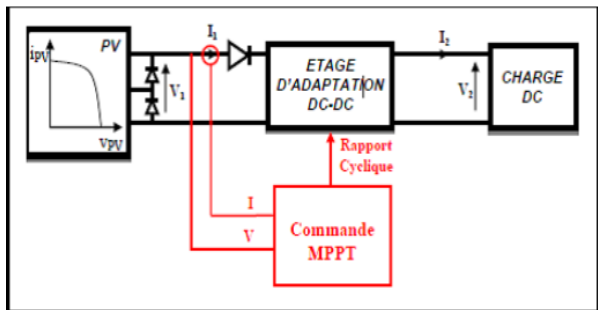
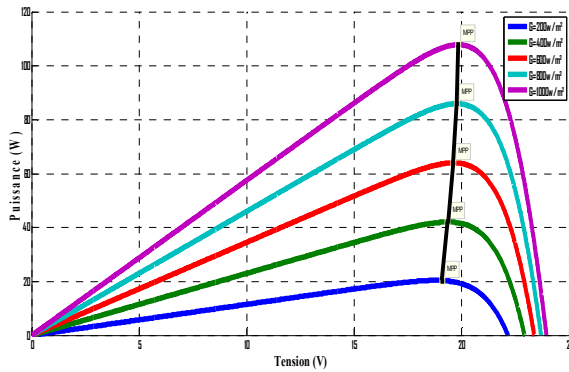
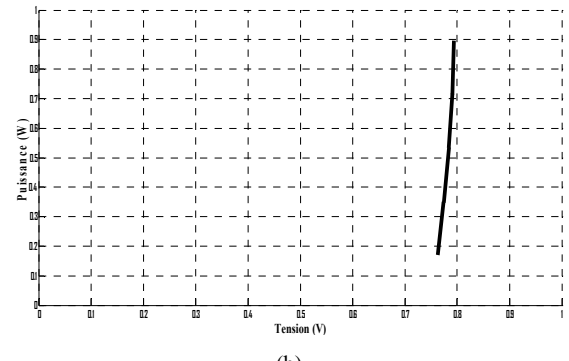

Fig. 9 Photovoltaic conversion chain associated with MPPT control



(a)



(b)

Fig. 10 Trajectory pursuit point MPPT for various radiations: (a) MPPT collected with variable solar irradiance, (b) Trajectory pursuit point MPPT

A. Pursuit Algorithm MPPT

1. Approach Conductance Increment

Several different algorithms exist to extract the maximum power from the PV array. We develop in this work, the increment technique conductance Matlab / Simulink, the operation of a photovoltaic generator linked to a follower of the maximum power point tracking (MPPT) based on this algorithm, voltages and currents panel are measured so that the controller can calculate the conductance and the incremental conductance and so decides his behavior[2],[6].

We define the conductance by  $G = \frac{I}{V}$  and the incrementation by:

$$dG = \frac{dI}{dV}$$

Eventually derive power from the voltage gets [10]:

$$\frac{1}{V} \cdot \frac{dP}{dV} = G + dG \tag{2}$$

We just have to search for what the conductance  $G = dG$ , depending on the value of G three cases to consider:

$$dG = -G \left( \frac{dP}{dV} = 0 \right)$$

$$dG > -G \left( \frac{dP}{dV} = 0 \right) \quad (3)$$

$$dG < -G \left( \frac{dP}{dV} = 0 \right)$$

The above equations are used to determine the direction in which the disturbance is produced to move the operating point to the MPP (maximum power point). This disturbance is repeated until  $\left( \frac{dP}{dV} = 0 \right)$  is satisfied. The following figures show the simulation results:

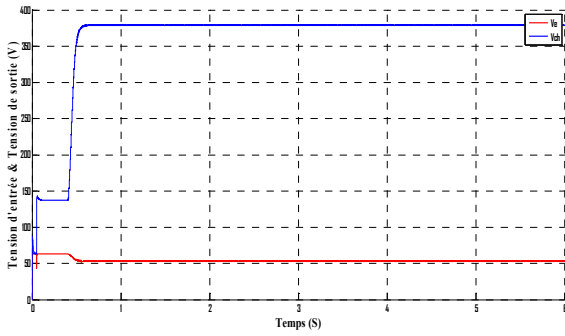

(a)

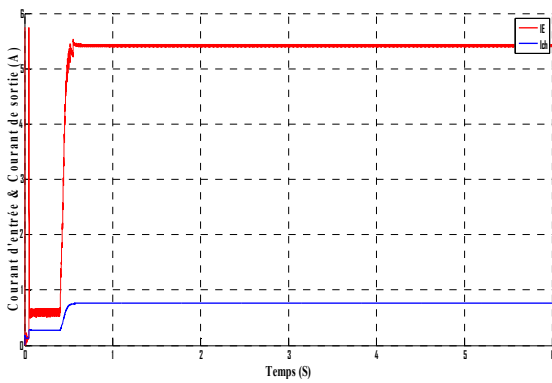

(b)

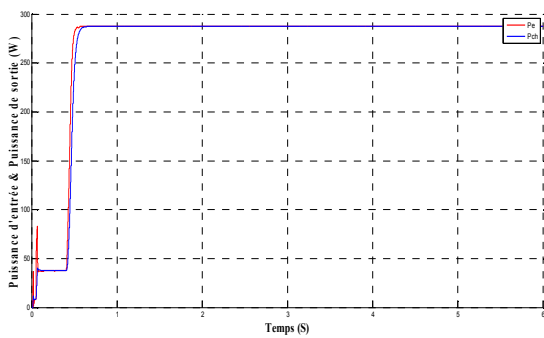

(c)

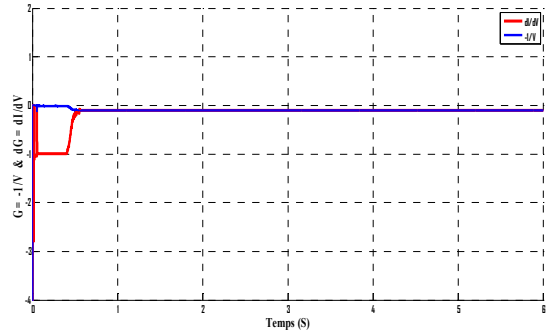

(d)

Fig. 11 Parameters behavior following algorithm of conductance incrementing on the CI at G and T fixed: (a) Voltage, (b) Current, (c) Power, (d) Conductance

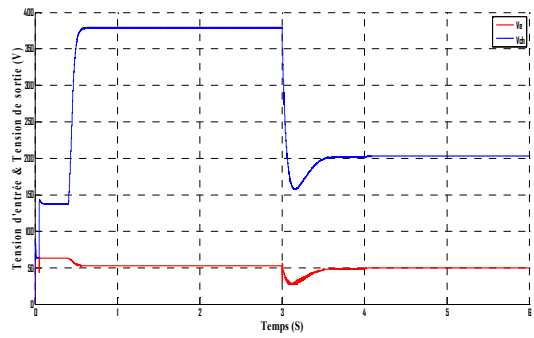

(a)

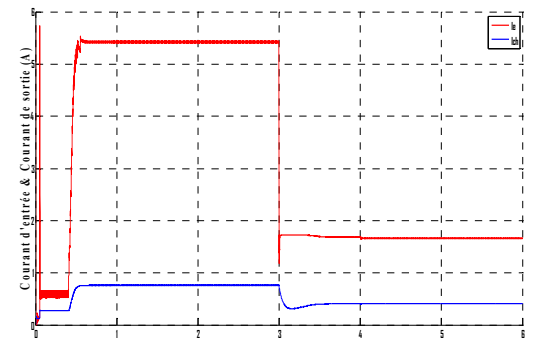

(b)

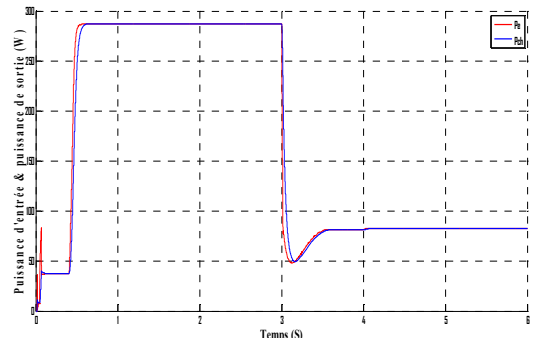

(c)

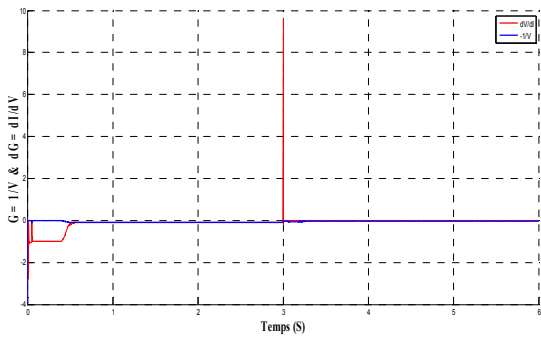

(d)

Fig. 12 Parameters behavior following the algorithm CI at negative jump of the irradiance G: (a) Voltage, (b) Current, (c) Power, (d) Conductance

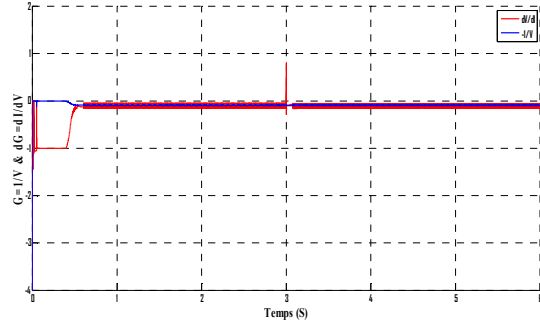

(d)

Fig. 13 Parameters behavior following the algorithm CI at positive jump of the irradiance G: (a) Voltage, (b) Current, (c) Power, (d) Conductance

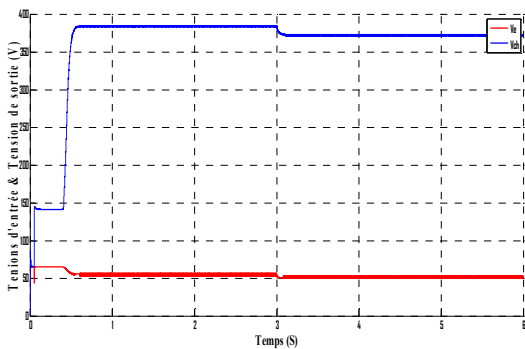

(a)

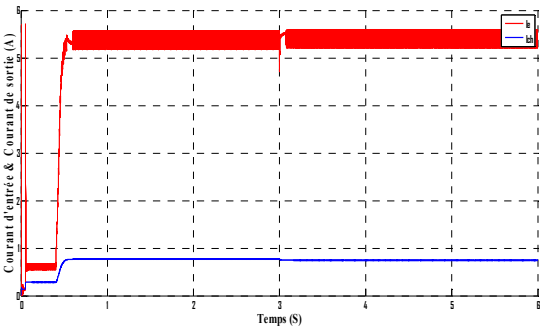

(b)

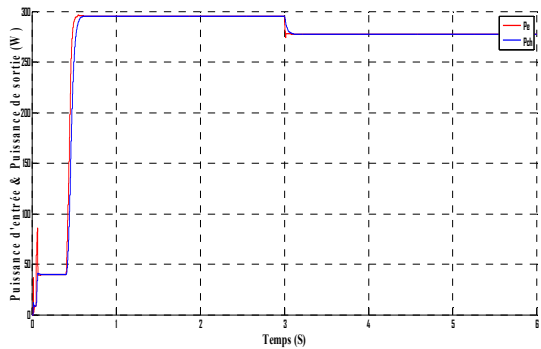

(c)

TABLE I

MONTHLY ENERGY CONSUMED IN 2012[15]-[16]

Month	Energy consumed in 2012 kWh
1	
2	
3	848118
4	
5	
6	873190
7	
8	
9	833361
10	
11	
12	975732

2. Analysis Results

The temporal analysis makes it possible even in the first place, the difference between the value of the voltage at the input and at the output of chopper converter, where the output voltage is higher than the input voltage, which is the behavior Boost the system, after a transitional period of 0.5s, the permanent state is reached.

For output power, we note that once the maximum power point (MPP) is reached, the MPPT control maintains constant.

After a short transient 0.5s, the current and voltage of the generator are adjusted to their optimum values of 0.76 A and 372.13 V successively. When the level of solar radiation changes abruptly by an upward or downward jump, for example of 1000 W/m<sup>2</sup> to 300 W/m<sup>2</sup>, the electrical variables of the generator are adjusted to their new optimum values A and 0.41 203.67V successively.

For the variation of the power generator (Fig. 13), it behaves the same way as other electrical quantities (current and voltage), power is also changing and the average values are close to equilibrium optimal power gains are to 287.46 W 1000 W/m<sup>2</sup> and 82.80 W/m<sup>2</sup> to 300 W/m<sup>2</sup>, All which corresponds to the indications of the industrial manufacturer.

V. CASE STUDY

Ferkene is a commune in the daïra Negrine of the wilaya of Tebessa in Algeria (Fig. 14) is composed of two groups of

dwellings; Djarech and Ferkane city, it is located 170km south of the capital of the Tébessa in northern town Ferkane is Stah-Guentis and the border of the province of Khenchela, east of the town Negrine, west border of the province of Khenchla and south of the province Eloued. Ferkane extends over 903km<sup>2</sup> area, with a population of 5695 residents [14].

The common Ferkane is a semi-arid or desert area that is part of the daïra Nigrine in the southern province of Tébessa and has enormous resources in solar energy potential confirmed by the map of the solar reservoir established by the SOLARGIS specialized software online [17].

#### A. Geographical Characteristic

The Tébessa region is an area of transition weather, considered agro-pastoral with a presence of a large number of events (intense sunlight, frost, hail, flood, high winds). Tébessa is characterized by four climatic areas [18]:

- The sub-humid (400-500mm/year), very little extended, it covers only a few subdivisions limited to the tops of some relief (and Jebel Serdies and Jebel Bouroumane)
- The semi-arid (300-400mm/year), representing in cool and cold floors and covers the entire northern part of the province
- The sub-arid (200-300mm/year) covers the steppe plateaus OumAli, Safsaf Elouesra, Tthlidjen and Bir Elater
- The arid and Saharan soft (-200mm/year), begins and extends beyond the Sahrien Atlas covers and trays Negrine and Ferkane

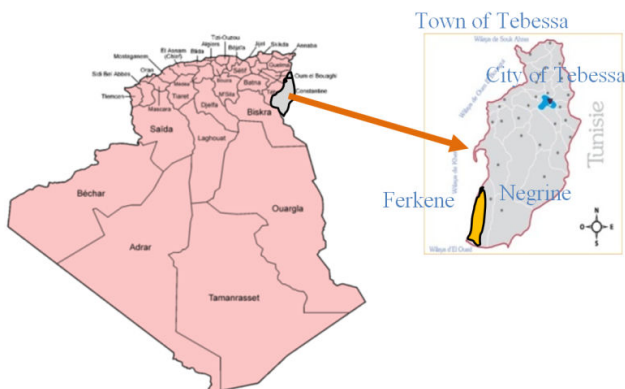

Fig. 14 Geographical location of the site

#### B. System Sizing Photovoltaic Production

Sizing and design of a specific PV system is actually relatively difficult because of the many parameters to consider surgery, some imponderable dose (meteorology) and especially interactions between multiple choices. For example the consumption of the charge controller, the inverter and the storage battery must be added to the set of receivers for total consumption of the system. However, the choice of these parameters depends on the size of the photovoltaic field, which is determined by the consumption of the load. So the design of a photovoltaic system is the result of an optimization performed by iterations.

#### Step 1: Needs Assessment

The solar kWh is expensive, it must make a saving at the receptor level by low-energy technology, the overall cost of the system will be much smaller because there will be fewer solar modules and batteries in the system.

For ease of calculation, we divide the town into five Ferkane equivalent areas in consumption of electrical energy. Taking the power consumption of the last quarter when the total consumption of the town is the highest which is divided into five.

For each zone, consumption will  $Ec_{zq} = 195,146.4$  kWh and daily consumption is  $Ec_{zd} = 2121.16$  kWh

The consumption of the town is the highest which is divided into five. For each zone, consumption will  $Ec_{zq} = 195,146.4$  kWh and daily consumption is  $Ec_{zd} = 2121.16$  kWh.

#### Step 2: Solar Energy Recoverable

- Orientation and Inclination of the Panels

The choice to vary the angle of PV modules every month during the year to recover the maximum amount of solar energy is very difficult in our case because of the great power to install. The solution is to choose an optimal inclination angle that allows us reach our goal of optimal design.

The online software PVGIS available on the website of the European Commission allows us to obtain the value of this angle is 31° from the geographic coordinates of Ferkane municipality.

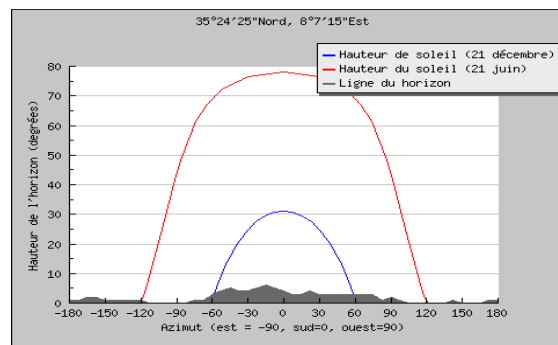

Fig. 15 Variation of the sun position in Ferkane municipality [17]

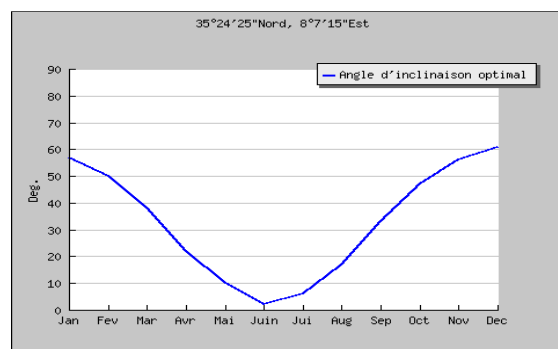

Fig. 16 Variation of the optimum angle of inclination of Ferkane municipality [17]

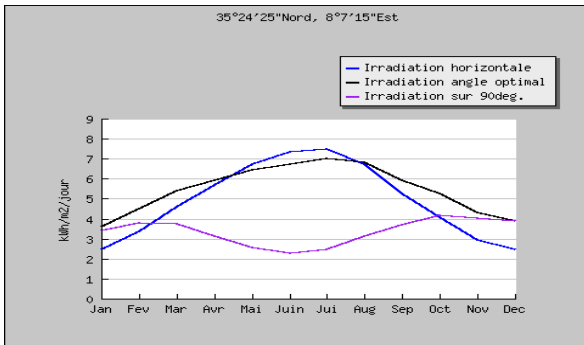

Fig. 17 The solar irradiance received on a horizontal plane at an optimum angle and 90 ° for Ferkene [17]

• Weather Data

We can make a fairly accurate sizing with 12 values of solar radiation received in the municipality of Ferkene given by the Photovoltaic software.

Step 3: Definition of Photovoltaic Panels

• Electricity Production of a Module in a Single day:

The electrical production of PV module during one day is given by the following equation:

$$E_{prod} = N \cdot P_c \tag{4}$$

$E_{prod}$ : Energy produced (Wh)

$N$ : exhebtion Hours Number in STC conditions

$P_c$ : peak power (W)

TABLE II

VARIATION OF SOLAR IRRADIATION AT OPTIMUM ANGLE [13]

Month	1	2	3	4	5	6
G (Wh/m²)	3090	4270	5360	5780	6100	6550
Month	7	8	9	10	11	12
G (Wh/m²)	6740	6640	5760	5240	4130	3740

G (Wh/m²) is solar irradiance at optimum angle

• Electrical Losses:

The inevitable current losses are introduced in the energy calculations as a known coefficient  $C_p$ : current loss coefficient. For soil loss is generally take  $C_p$  between 0.8 and 1, the "state of panels: they are cleaned regularly placed horizontally behind a glazing.

For lead storage batteries used in photovoltaic, the Ampere hour Ah efficiency between 0.8 and 0.9 depending on their characteristics.

• Quantification of Losses

If we combine the previous losses, the coefficient ( $C_p$ ) can vary between 0.64 (= 0.8 x 0.8) and 0.9 (= 1 x 0.9) as appropriate (without glazing on modules). For our case study, dirt modules will not be a problem, users ensure their cleanliness, it will take only 5% loss on that side and the battery efficiency may be a loss of 0.8

The final calculation of the load current from the PV array, a current loss coefficient is:

$$C_p = 0.8 \cdot 0.95 = 0.76$$

• Practical Calculation of Photovoltaic Power

For more accurate sizing, we will use the highest consumption period value. In our case, for annual use, the average value of the fourth quarter will be used per day which is the highest. ( $E_{czd} = 2121.16$  KWh).

The timing of our study panel SOLARWATT including the following characteristics type:

$$\begin{cases} P_{max} = 220 \text{ W} \\ V_{opt} = 28.4 \text{ V} \\ I_{opt} = 7.76 \text{ A} \end{cases}$$

In consideration of the highest voltage of the devices to supply, in this case a voltage of 380 V, we need to place branches in series of 14 modules, that will deliver a voltage of  $V_p = 397.6$  V.

To find the energy consumed (Ah), we divide the energy (kWh /d) by 380V voltage: The voltage of a panel is 28.4 x 14 equal 397.6 V.

$$Q_{cons} = \frac{E_{cons}}{V_p} = \frac{2121.16}{397.6} = 5.34 \text{ KAh} \tag{5}$$

$Q_{cons}$ : Energy consumption (Ah)

$V_p$ : The highest voltage

The optimal current for each area will be:

$$I_{opt} = \frac{Q_{cons}}{E_{sol} C_p} \tag{6}$$

$$I_{opt} = \frac{5.34}{3090 \cdot 0.76} = 2273.88 \text{ A} = 2.27 \text{ KA}$$

$I_{opt}$ : Current at maximum power

$Q_{cons}$ : Electrical energy consumed per day (Ah/j)

$E_{sol}$ : Energie solaire journalière (kWh/m².j)

$C_p$ : Current loss coefficient

The modules that we have chosen in our case an optimal voltage ( $V_{opt} = 28.4V$ ), photovoltaic power ( $P_c$ ) system should be minimum for each zone.

$$P_{c,z} = V_{opt} \cdot I_{opt} \cdot 14 \text{ panels} = 904.09 \text{ KW}$$

$$P_{c,tot} = P_{c,z} \cdot 5 = 4520.45 \text{ KW}$$

• Photovoltaic Array (number of panels)

We recall that the module has a power of 220 W at 28.4 V. For our case study the number of modules for each zone is calculated:

$$N_M = \frac{P_c}{P_M} \rightarrow N_M = \frac{904094.69}{220} = 4110 \text{ modules} \tag{7}$$

$N_M$ : Number of modules

$P_c$ : power system

$P_M$ : peak power per unit module.

So for 380 V will require 14 modules in series in each branch and 294 branches → N modules, tot = 4116 modules. All results of the calculations are summarized:

$$\begin{cases} I_{opt} = 2.27 \text{ KA} \\ V_{opt} = 28.4 \text{ V} \\ N_M = 4116 \text{ modules, } N_{M,\text{total}} = 20580 \text{ modules} \end{cases}$$

#### Step 4: Sizing the Storage

- Autonomy without Solar Input: It's the period of a few days during which the battery can be supplied only the installation, for our case, we take equal five days ( $N_d=5d$ )
- Depth of Discharge: The proportion of the discharge capacity, we take ( $P_d = 0.7$ )
- Capacity Calculation: For our application, we get the result according to the calculation of the rated capacity (Ah) for each zone [8]-[10]:

$$C_{20} = \frac{Q_{cons} N_{ja}}{P_D}$$

$$C_{20} = \frac{5340 \cdot 5}{0.7} = 38142.85 \text{ Ah} = 38.14 \text{ KAh} \quad (8)$$

The total nominal capacity for the five area will:

$$C_{20,\text{tot}} = 190.7 \text{ KAh.}$$

$C_{20}$ : nominal capacity (Ah)

$N_{ja}$ : autonomy days Number without contribution (j)

$P_D$ : Maximum allowable depth of discharge.

#### 1) Number of Batteries

$$N_B = \frac{E_{cons}}{C_{bat} V_{bat}} = 895 \text{ batteries} \quad (9)$$

$$N_{B,\text{tot}} = N_B \cdot 5 = 4475 \text{ batteries}$$

#### Step 5: Sizing Regulator

In our system, the MPPT algorithm is given by the incrementation conductance IC in the control chain when the sizing the regulator must consider [11].

#### Step 6: Sizing the Inverter

Align the power of the photovoltaic field with that of the inverter is the first mission to reach. The inverter is given for its power output, so you can adjust the power of the field performance of the inverter [5], [6].

#### Step 7: Wiring Diagram

Once the system is designed, it remains to consider the practical operation of the installation wiring to ensure the coherence of the whole. The following illustration shows the wiring diagram.

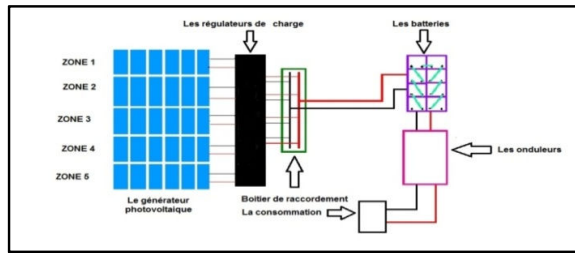

Fig. 18 Diagram of the photovoltaic array to supply Ferkene

#### C. Validation of Results

To validate our results, the Photovoltaic gives us the average values of electricity per day from the geographic location of website software is used, the angle of inclination and the installed PV power we calculated in the 3rd sizing step. Seen in the results obtained by calculating the daily consumption by area:  $E_{cdz} = 2121.16 \text{ KWh}$ , The production area:  $E_{prod} = 2200 \text{ Kwh}$ .

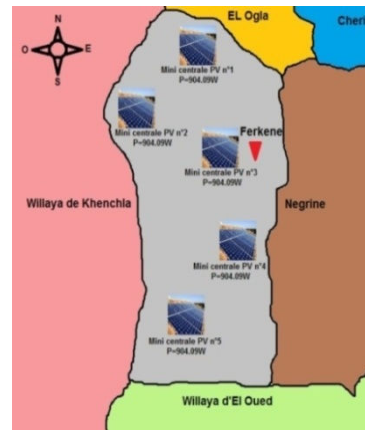

Fig. 19 Scenario of fictive distribution of mini solar power plants that feed the town Ferkène

We note that there is a satisfactory balance between consumption and production of electricity.

#### V. CONCLUSION

Through this work, we developed a design of a standalone photovoltaic conversion chain on a semi-arid area such as the common Ferkène in Tebessa north of the Algerian desert. To contribute to the solution of energy problems, it is of interest to develop alternative sources, renewable and decentralized energy of these. In the search for such solutions, the system of photovoltaic fields developed in this paper can be a very economical way for the electrification of this category of zones. Modeling and simulation of photovoltaic panels, research and control of the MPPT and the optimal design of the solar system is a very important asset of this contribution and open very motivating perspectives in the field of renewable energy and sustainable development.



## REFERENCES

- [1] Anne Laburet, Michel Viloz: *énergie solaire photovoltaïque* édition dunod –Paris, 2006.
- [2] D. Thévenard and M. Ross «validation and Verification of Component Models and System Models for the PV», *CETC-internal report* 2003-035, Canada, 2003.
- [3] D. Turcotte, M. Ross and F. Sheriff. «Photovoltaic hybrid System Sizing and Simulation Tools»; *article PV Horizon, Canada*, 2001.
- [4] Bendjellouli Zakaria : « Contribution a la modélisation d'une cellule solaire » *Mémoire de Magister. Université de Bechar*. 2008/2009.
- [5] Saheb-Koussa D et Haddadi M. Modélisation d'un générateur photovoltaïque dans l'environnement « Matlab ». *4th International Conférence on Computer Integrated Manufacturée CIP'2007*.
- [6] Hadj Mohammed, I. Boualit, S. I. Hadj Arab, A.Youcef, Application d'un modèle généralisé de courant - tension d'une cellule photovoltaïque pour des mesures extérieures sur le module de type monocristallin, Sharp NT-R5E3E. *Revue des Énergies Renouvelables*, pp : 149- 152. (2007).
- [7] Ben moussa W.C, Amara S et Zerga A. Étude comparative des modèles de la caractéristique courant-tension d'une cellule solaire au silicium monocristallin. *Revue des Energies Renouvelables*, pp : 301 - 306. (2007).
- [8] Hamza A, Abbassi H et Kermiche S. Modélisation et commande d'un système photovoltaïque. *CIFEMI*. (2010).
- [9] Angel-Cid-Pastor M. Conception et réalisation de modules photovoltaïques électriques *Thèse de doctorat. Université de Toulouse*. France. (2006).
- [10] Chayawatto N, Kirtikara K, Monyakul V, Jivacate C, Chenvidhya D. DC-AC switching converter modelings of a PV grid-connected System under isolanding phenomena. *Renewable energy*. Volume. 34. pp : 2536-2544. (2009).
- [11] Hadj arab, F. chrifa, A. chouder and F.chenlo, grid-connected photovoltaic at CDER-Algeria ,*20<sup>th</sup> European photovoltaic solar energies conference and exhibition* . Barcelona .6-10 june 2005.
- [12] L.Castaner and S. Santiago, Modeling photovoltaic systems Using Pspice , john Wiley & Sons, LTD.
- [13] Official document of data planification from wilaya of Tebessa, 2102
- [14] Agency Meteorological maps of Tebessa, 2012.
- [15] [www.mem.dz](http://www.mem.dz) 2013
- [16] [www.sonelgaz.dz](http://www.sonelgaz.dz) 2013
- [17] [www.solargis.com](http://www.solargis.com) 2012
- [18] [www.Atlas.org](http://www.Atlas.org) 2012