

# Influence of Composition and Austempering Temperature on Machinability of Austempered Ductile Iron

Jagmohan Datt, Uma Batra

**Abstract**—Present investigations involve a systematic study on the machinability of austempered ductile irons (ADI) developed from four commercially viable ductile irons alloyed with different contents of 0, 0.1, 0.3 and 0.6 wt.% of Ni. The influence of Ni content, amount of retained austenite and hardness of ADI on machining behavior has been conducted systematically. Austempering heat treatment was carried out for 120 minutes at four temperatures- 270°C, 320°C, 370°C or 420°C, after austenitization at 900°C for 120 min. Milling tests were performed and machinability index, cutting forces and surface roughness measurements were used to evaluate the machinability. Higher cutting forces, lower machinability index and the poorer surface roughness of the samples austempered at lower temperatures indicated that austempering at higher temperatures resulted in better machinability. The machinability of samples austempered at 420°C, which contained higher fractions of retained austenite, was superior to that of samples austempered at lower temperatures, indicating that hardness is an important factor in assessing machinability in addition to high carbon austenite content. The ADI with 0.6% Ni, austempered at 420°C for 120 minutes, demonstrated best machinability.

**Keywords**—Austempering, machinability, machining index, cutting force, surface finish.

## I. INTRODUCTION

AUSTEMPERED ductile irons (ADIs) are being used, worldwide, for high performance applications in the automotive, rail and heavy engineering industries due to improved production efficiency, reduced cost, and combination of excellent mechanical properties such as hardness, strength, ductility and toughness. ADIs exhibit unique microstructure of ausferrite comprising of acicular ferrite and high carbon austenite called “Ausferrite” [1]. Previous investigations have reported that the composition of base ductile iron and the structural parameters of ADI such as volume fraction of austenite, carbon content of austenite, ferrite particle size and morphology of ausferrite, control the mechanical properties [2]-[9].

Machining is an important step in the production of components that normally controls the cost. Ductile iron exhibits good machinability due of the presence of graphite

nodules, and therefore, results in low tool wear rate, high metal removal rate and relatively low cutting forces during the machining operation [10]. Austempering of ductile iron enhances its strength and wear resistance so that ADI poses big problems during machining. ADI has been assumed to be non-machinable by many manufacturers [11]-[13]. This is often due to its high hardness. It is also due to improper machining practices. The attempt to machine ADI like an as-cast ductile iron should not be expected to succeed. Fig. 1 shows the relative machinability of ADI compared to other materials. ADI is not as easily machined as pearlitic or ferritic ductile iron, but is comparable to 30Rc hardened steel in metal removal rates.

ADI is often alloyed with elements such as copper, nickel, molybdenum and manganese to increase the austemperability of the material. Carbide-forming elements such as molybdenum and manganese tend to segregate toward cell boundaries during the casting process [6]-[8]. Their carbides can be very detrimental to the machining process, and significantly reduce tool life. It is recommended from prior research that the use of molybdenum be reduced as much as possible, particularly in the presence of higher Mn levels [6]-[8]. Copper and nickel can be used in place of molybdenum and manganese to compensate for reduction in austemperability [9]. In contrast to molybdenum and manganese, copper and nickel do not segregate at cell boundaries or form carbides and therefore not expected to pose detrimental effect on machining.

In austempering heat treatment, the ductile iron casting is subjected to austenitization in a temperature range of 850–950°C, for sufficient time to saturate the austenite with carbon after which castings is subjected to an isothermal quenching at a temperature range of 250–450°C where the primary austenite partially transforms to ferrite (first stage of reaction). At longer austempering times, the austenite, which is present in the microstructure, further, decomposes to ferrite and fine carbides. This second stage of reaction is not desirable and must be restricted because it severely depreciates the mechanical properties and machinability. The austempering temperature determines the amount, morphology and size of phases present in the microstructure. Austempering treatment at lower temperature results extremely fine ferrite plates separated by thin films of high carbon austenite, whereas, more equiaxed blocks of austenite between non parallel “sheaves” of ferrite platelets results at higher austempering temperature [8], [9]. At higher austempering temperatures, the

Mr. J.D. Sharma is Assistant Professor with Dept. of Materials and Metallurgical Engineering, PEC University of Technology, Chandigarh-160012, India (corresponding author; phone: +91-9417084872; fax: +91-172-2745175; e-mail: jd\_pec@yahoo.com).

Dr. Uma Batra is Professor with the Deptt. of Materials and Metallurgical Engineering, PEC University of Technology, Chandigarh-160012, India (e-mail: umabatra2@yahoo.com).

amount of austenite can reach up to about 40%; however, it drops to nearly 10% at lower temperatures [14]. During machining, the force of the tool can cause a localized transformation in the material in front of the tool. The austenite on the surface undergoes a strain induced transformation to Martensite right in front of the tool face by TRIP effect [15]-[17]. Martensite being harder and more brittle than the Ausferrite, poses difficulty in machining. At any particular austempering temperature the austempering time must be chosen to optimize the mechanical properties through the formation of a stable structure of ausferrite [18]. This appropriate time can be defined as the time interval over which the amount of un-reacted austenite volume in the form of martensite is not sufficient to deteriorate the mechanical properties and machinability [19], [20].

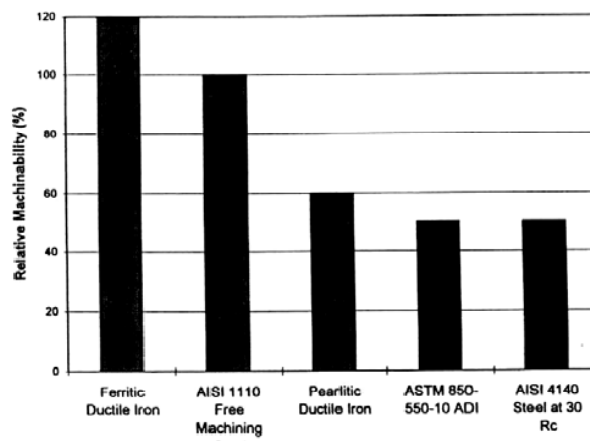

Fig. 1 Relative machinability of several ferrous materials

TABLE I  
CHEMICAL COMPOSITION OF DIS

Element	C	Mg	Si	Mn	Mo	Cu	Ni	S	P	Al	Fe
DI-0	3.59	0.06	2.71	0.35	0.24	0.60	-	0.016	0.018	0.02	Rest
DI-1	3.59	0.06	2.71	0.35	0.24	0.85	0.1	0.016	0.018	0.02	Rest
DI-3	3.59	0.06	2.71	0.35	0.24	0.85	0.3	0.016	0.018	0.02	Rest
DI-6	3.59	0.06	2.71	0.35	0.24	0.85	0.6	0.016	0.018	0.02	Rest

It is commonly recommended that the machining operation is done on ADI products prior to austempering, on the base ductile iron. However, one of the challenges in the application of ADI is to maximize the machinability of the material after austempering by choosing a suitable chemical composition and heat treatment cycle. Present work aims to study the machinability of ADI developed from four commercially viable ductile irons alloyed with different contents of 0, 0.1, 0.3 and 0.6 wt. % of Ni. The influence of Ni content, amount of retained austenite and hardness of ADI on machining behavior has been conducted systematically.

## II. MATERIALS AND METHODS

Four ductile irons of compositions given in Table I were produced in a commercial foundry using an induction melting furnace of medium high frequency. In present work, commercially viable ductile irons with minimum possible manganese content were produced. Copper and nickel were chosen to compensate for reduction in austemperability due to lowering of molybdenum and manganese contents. Copper and nickel, in contrast to molybdenum and manganese, does not segregate at cell boundaries and therefore supports uniformity in austempered structure. The molten metal was poured from about 1420°C in a ladle preheated to 800°C for sandwich treatment by spheroidization technique using Fe-Si-

Mg alloy (5 to 7% Mg) for nodulizing and FeSi (65% Si) for inoculation. Post inoculation was performed with FeSi (65% Si). The molten metal was cast immediately in the shape of modified 2.5cm (1-inch) Y-blocks shown in Fig. 2. The qualitative and quantitative analysis of microstructure of the as-cast ductile iron (DI) was observed under optical microscope with Image Analyzer attachment (Carl Zeiss). The structural parameters of four DIs are presented in Table II. The samples of 10 x 25 x 100 mm rectangles were machined from the leg part of the Y-block castings. These samples were austenitized at 900°C for 120 minutes, transferred rapidly to a salt bath held at pre-selected austempering temperature (270°C, 320°C, 370°C or 420°C) and soaked for 120 minutes before quenching in water (Fig. 3). The austempered samples were designated as given in Table III. Metallographic examination of ADI samples was carried out using scanning electron microscopy (SEM, JEOL 840A). X-ray diffraction analysis (XRD, PW 1148/89) was performed on ADI samples using Cu K $\alpha$  radiation ( $\lambda=1.54 \text{ \AA}$ ) at 40 KV and 20 mA in 2 $\theta$  range 40° to 93°, step size 0.1°, with count time of 2 seconds per step. The carbon content in austenite ( $C^{\gamma}$ ) after water quenching of DI from austenitization temperature was calculated using empirical relation given by (1) [16]:

$$C^{\gamma} = (T_{\gamma}/420) - 0.17(\text{wt. \% Si}) - 0.95 \quad (1)$$

TABLE II  
STRUCTURAL AND MECHANICAL PROPERTIES OF DIS

DI	Nodule count, mm <sup>-2</sup>	Nodule size, mm	Nodularity %	Amount of Ferrite, %	Amount of Pearlite, %	Hardness Hv10
DI-0	200	0.04	98	10	90	270
DI-1	200	0.04	98	10	90	256
DI-3	200	0.04	98	5	95	238
DI-6	180	0.04	95	4	96	208

The averages of volume fraction of austenite,  $X_\gamma$ , average carbon content of high carbon austenite,  $C_\gamma$ , and the effective "ferrite particle size"  $d_{\alpha}$ , in ausferrite product were estimated from XRD patterns for all ADIs under investigation following procedure described by Cullity [21]. Hardness of DI and ADI samples was measured using Vicker's Hardness Tester (IE make) with 10 kg load. Tensile tests were performed for DI and ADI samples on universal tensile testing machine of 20 tons capacity, UTS-20 (FI make) to estimate ultimate tensile strength (UTS), 0.2% proof stress ( $\sigma_{0.2}$ ), and percent elongation (% El). Strain hardening coefficient,  $n$ , was calculated for each ADI using Holloman relationship [22].

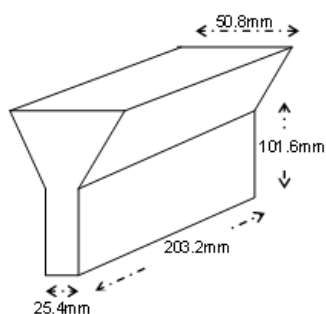

Fig. 2 Modified 1 inch 'Y' block of Ductile Iron Casting

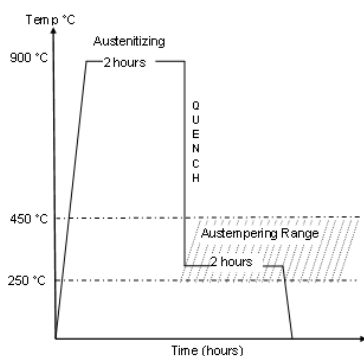

Fig. 3 The Austempering Heat Treatment Cycle (Shaded area represents the possible range of austempering temperature)

TABLE III  
SAMPLE DESIGNATIONS

DI	Austempering Temperature, °C			
	270	320	370	420
DI-0	ADI-0A	ADI-0B	ADI-0C	ADI-0D
DI-1	ADI-1A	ADI-1B	ADI-1C	ADI-1D
DI-3	ADI-3A	ADI-3B	ADI-3C	ADI-3D
DI-6	ADI-6A	ADI-6B	ADI-6C	ADI-6D

In present study, the machining evaluation was performed on horizontal milling machine. High Speed Steel (HSS) milling cutter having diameter of 77.30mm was used as tool for machining operation. The cutter head containing the milling machine spindle was attached to the ram. The saddle and knee were hand driven for vertical and cross feed adjustment. For all samples machining parameters were

maintained at a cutting speed ( $V_c$ ) of 54 m/min., cut depth ( $a_p$ ) of 0.5 mm, and a feed rate ( $f$ ) of 0.41 mm/revolution. No coolant was used during the machining. The axial cutting force was measured with the help of a Dynamometer KISTLER model 9257 B coupled with multi channel KISTLER amplifier Type 5070A and data acquisition software Type 225A-02. A roughness meter SJ 201 Mitutoyo was selected to measure surface roughness ( $R_a$ ). Machinability Index (MI) was measured for all ADIs with respect to a DI-0 following procedure explain in Westerman Tables [23], [24]. The DI-0 was assigned an MI of 100. Accordingly, the MI is given by (2).

$$MI = U_{PS} / U_{PA} \quad (2)$$

where,  $U_{PS}$  is the unit power consumption for DI-0 and  $U_{PA}$  is the unit power consumption by an ADI.

Here  $U_p = U_{PS} / U_{PA}$  is in KW/milligram and Power consumed (KW) is calculated using (3);

$$P = \frac{9.8 * F * V}{60 * 1000} * X * C \quad (3)$$

where,  $F_x$  is the main cutting force in Kgf and  $V_c$  is cutting speed.

### III. RESULTS

#### A. Microstructure

The SEM micrographs of ADI-6 austempered at 270°C, 320°C, 370°C, and 420°C are shown in Fig. 4. All ADIs exhibit unique microstructure of ausferrite comprising of acicular ferrite and high carbon austenite. Fig. 4 (a) shows microstructure of ADI-6, austempered at 270°C in which extremely fine ferrite plates are separated by thin films of high carbon austenite. The ferrite plates have grown in length as well as width in ADI-6 when austempered at 320°C (Fig. 4 (b)). ADI-6 consists of more equiaxed blocks of austenite between non parallel "sheaves" of ferrite platelets when austempered at 370°C, and 420°C (Figs. 4 (c) and (d)). The variations in the microstructures of ADI-0, ADI-1, and ADI-3 with austempering temperatures were similar to those observed in ADI-6.



(a)

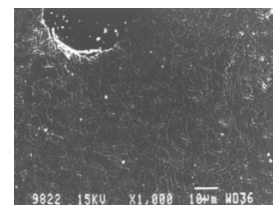

(b)

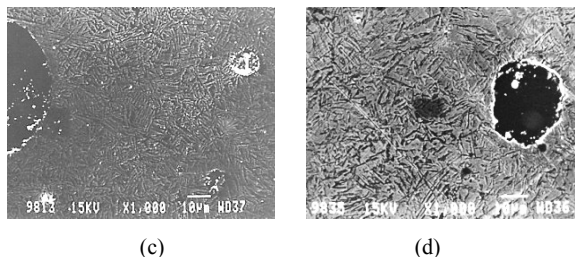

Fig. 4 Microstructure of (a) ADI-6A, (b) ADI-6B (c) ADI-6C (d) ADI-6D

### B. Structural Parameters and Hardness

The  $X_\gamma$  and  $d_\alpha$  estimated from XRD patterns of all ADIs are presented in Table IV. It is evident that  $d_\alpha$  and  $X_\gamma$  increase appreciably with rise in austempering temperature from 270°C to 420°C, and it is in agreement with the trend reported earlier [2], [5]. The hardness of ADIs decreases with increasing austempering temperature (Table IV).

### C. Machinability Index

The machinability index (MI) measured on DIs, and ADIs are compared in Table IV. As expected, machinability of DI-0

was found to be superior to all other DIs or the ADI samples, irrespective of Ni content in starting DI or the austempering temperature, therefore, it was considered as base for comparison. The MI increased appreciably with increase in austempering temperature from 270°C to 420°C in all ADI samples. However, for a selected austempering temperature, change in Ni content of starting DI causes little change in MI.

### D. Cutting Force

Fig. 5 shows that DI-0 required minimum cutting force for milling operation. The cutting force of DI samples and ADI samples austempered at austempering temperatures of 270°C, 320°C, 370°C, or 420°C, increased with the increase in Ni content. The cutting force decreased with the increase in austempering temperature for all ADI-0, ADI-1, ADI-3, and ADI-6. ADI samples austempered at 420°C required marginally higher cutting force in comparison to their starting DIs. The difference continued to increase with decrease in austempering temperatures up to 270°C. It can be concluded that samples austempered at a higher temperature had significantly higher machinability.

TABLE IV  
 $X_\gamma$ ,  $d_\alpha$  HV10 AND MACHINABILITY INDEX (MI) OF ADIS

	ADI-0A	ADI-0B	ADI-0C	ADI-0D	ADI-1A	ADI-1B	ADI-1C	ADI-1D	ADI-3A	ADI-3B	ADI-3C	ADI-3D	ADI-6A	ADI-6B	ADI-6C	ADI-6D
$X_\gamma$ , Vol fraction	0.20	0.23	0.38	0.40	0.20	0.23	0.39	0.41	0.22	0.24	0.39	0.41	0.22	0.24	0.40	0.42
$d_\alpha$ , nm	17	18.5	21	23	17.4	19	22	24.5	18.2	21.6	26.3	28.2	19	22	27	28
HV10	407	399	327	308	412	410	325	307	410	398	322	302	405	390	320	298
MI	69	81	92.5	99.6	74.4	83.2	87.1	98	72.9	79.1	85.9	95.8	74.6	80.4	84.8	97.1

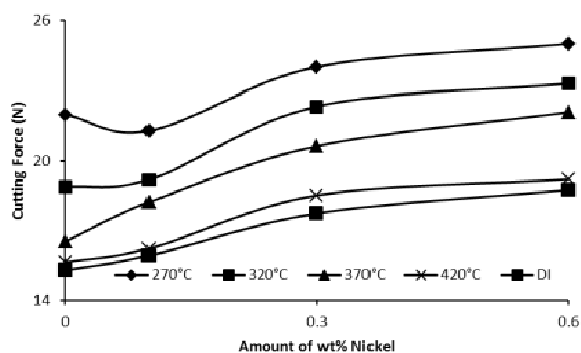

Fig. 5 Cutting force (N) for all DIs and ADIs

### E. Surface Roughness

Testing was conducted according to DIN 4768 standard. Machining surface quality was measured for test pieces which were machined under the conditions described above. The results are shown in Fig. 6. Lower  $R_a$  corresponds to a better surface finish. It is obvious that at constant cutting speed and cutting depth, increasing the austempering temperature improves the surface quality. In present case, for a cutting speed of 54 m/min., feed rate of 0.41mm/rev, and cutting depth of 0.5mm, ADI-6 austempered at 420°C exhibited the best surface quality and the least  $R_a$  and this can be related to a better machinability.

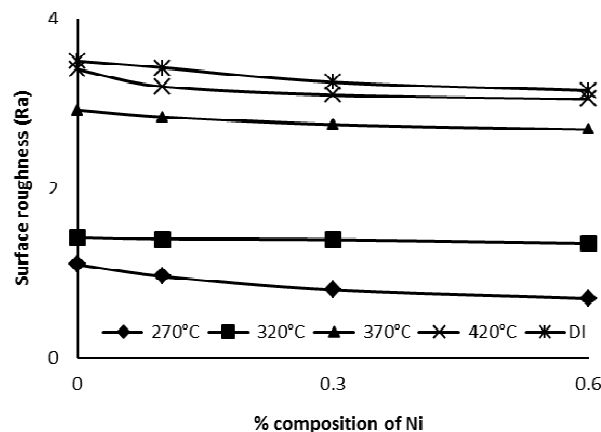

Fig. 6 Surface Roughness ( $R_a$ ) of DI and ADI samples

## IV. DISCUSSION

It is critical to choose a suitable austempering time to gain optimized mechanical properties since the nature and amount of phases present in the microstructure affect hardness. Austempering temperature strongly influences the amount and morphology of the phases present in the microstructure and consequently the mechanical properties and machinability. Fig. 3 shows typical micrographs of ADI-6 specimens after austempering at optimum times for each austempering

temperature. The results were similar for ADI-0, ADI-1, ADI-3, and ADI-6. Higher austempering temperature results in coarser ferrite and also higher amount of high carbon austenite, which in turn reduces the hardness of the specimen (Table IV). In contrast, when the austempering heat-treatment is carried out at lower temperatures of 270°C and 320°C, it results in a higher nucleation rate of ferrite and consequently the microstructure contains finer ferrite and lower volume fraction of high carbon austenite and that is why these specimens show higher hardness. High carbon austenite transforms to martensite during machining and makes the microstructure harder to be machined. Therefore, it seems that presence of austenite in the microstructure will reduce the machinability. The variation of austenite content with austempering temperature is given in Table IV. According to the X-ray diffraction results, specimens which were austempered at 370°C and 420°C contain about 38% and 42% of high carbon austenite in the microstructure. However, this is only 20% and 24% for austempering temperatures of 320°C and 270°C, respectively. Therefore it can be inferred that, presence of austenite in the microstructure is not the only factor that reduces machinability. Otherwise the samples austempered at higher temperatures would have a lower machinability in comparison with those austempered at lower temperatures due to their higher amount of austenite. However, results show that higher austempering temperatures results in a higher machinability compared to that of lower austempering temperatures. As shown in Table IV, hardness is very sensitive to variations of austempering temperature and it is certain that changing hardness affects the machinability. Additionally, producing a sound casting, without any microstructural defects, is an essential factor for machinability improvement and a perfect microstructure will help the machinist to machine the product more easily. For this purpose care must be taken in selection of the alloying elements and casting procedure. In this study, addition of nickel in ADI has clearly indicated improvement in machinability, which is expected due to its tendency to result into more uniform austempered structure and reduction in carbides at the eutectic cells.

When a high normal force is applied to ADI, a strain induced phase transformation occurs on the surface of the part. The force exerted by the tool during milling can cause a localized phase change in the material in front of the tool. Austenite on the surface undergoes a transformation to martensite which is harder and more brittle. Therefore, this transformation right in front of the tool face makes the material even more difficult to be machined [25]. Avishan et al. [26] have shown that the hardness of the machined surface will be increased as a result of a TRIP effect on the surface of the specimens during machining under applied force. The variation of the surface hardness at cut depth were studied and it was shown that specimens austempered at 420°C have a lower hardness compared to that of specimens which were austempered at 270°C, 320°C, and 380°C. Therefore, this hardness change at the machining surface can further influence the machinability. As this increase is more severe in

lower austempering temperatures, then it will reduce the machinability strongly. It can be seen in Table IV that MI of specimens' austempered at 420°C was highest. Because of the higher hardness of parts austempered at lower temperatures, MI was lower. During machining the tool/product interface locally becomes very hot, and this is very effective in reducing the machinability. This is more evident during the machining of samples austempered at lower temperature, because, hardness change is very sensitive to austempering temperature variations. According to Table IV, a lower austempering temperature promotes hardness. As shown in Fig. 4 and Table IV, structural features responsible for this are the fine distribution of acicular ferrite plates and low level of austenite. However, at higher austempering temperatures, the upper ausferrite structure contains more austenite, feathery ferrite and no carbides. These reduce the hardness and improve the ductility effectively [26], [27]. That is why the temperature at the tip of the machining tools rises severely in contact with the specimen surface during the machining of the test pieces which were austempered at lower temperature. According to Fig. 6, samples austempered at a higher temperature showed better surface roughness, which is a result of the easier metal removal. Increasing the austempering temperature to 420°C improves the machinability considerably. When the hardness of products increases, metal removal becomes harder. The machinability of the softer grades of austempered ductile irons is equal to or better than that of steels with similar strength [18]. In general, although the machinability of ADI is lower than regular pearlitic and ferritic ductile irons, they can be machined more easily than steels of the same hardness. This indicates that from the machining point of view, replacement of the steel products with softer grades of ADI is practical if mechanical properties are securing. This can help industry to use ADI for its economic advantages.

## V. CONCLUSIONS

The following conclusions are drawn from the present study:

1. The ductile iron without nickel offer least cutting force, and it increases with the increasing concentration of nickel in the ductile iron.
2. The cutting force of ADI decreases with increase of austempering temperature for all compositions of nickel and increases with increasing nickel concentration at all austempering temperatures.
3. The cutting force requirement for ADIs austempered at 420°C approaches to their starting DIs. Therefore, austempering at 420°C is considered an ideal heat treatment condition for achieving machinable ADI.
4. The best surface finish during machining is found to be function of hardness. In present case, ADI6D displayed the best surface finish.
5. ADI6D also demonstrated the best machinability index among the ADIs investigated in present study.

## REFERENCES

- [1] M. N. Ahmadabadi, H. M. Ghasemi, and M. Osia, "Effects of Successive Austempering on Tribological Behavior of Ductile Cast Iron," *Wear*, 1999, vol. 231, pp. 293–300.
- [2] K. L. Hayrynen, D. J. Moore, and K. B. Rundman, "Tensile and Fatigue Properties of Relatively Pure ADI," *Trans. AFS*, 1992, vol. 100, pp. 93–104.
- [3] T. N. Rouns, K. B. Rundman, and D. J. Moore, "On the Structure and Mechanical Properties of ADI," *Trans. AFS*, 1984, vol. 92, pp. 815–40.
- [4] T. S. Shih, C. S. Chang, and L. Z. Huang, "Mechanical Properties and Microstructures of Austempered Ductile Iron," *Trans. AFS*, 1991, vol. 107, pp. 793–808.
- [5] R. B. Gundlach, and J. F. Janowak, "Austempered Ductile Iron Combines Strength with Toughness and Ductility," *Met. Prog.*, 1985, vol. 128, pp. 19–26.
- [6] N. Darwish, and R. Elliot, "Austempering of Low Manganese Ductile Iron, Part 3. Variation of Mechanical Properties with Heat-Treatment Conditions," *Mater. Sci. Technol.*, 1993, vol. 9, pp. 882–89.
- [7] D. J. Moore, T. N. Rouns, and K. B. Rundman, "The Relationship between Microstructure and Tensile Properties in Austempered Ductile Iron," *Trans. AFS*, 1987, vol. 95, pp. 765–74.
- [8] D. J. Moore, T. N. Rouns, and K. B. Rundman, "Structure and Mechanical Properties of Austempered Ductile Iron," *Trans. AFS*, 1985, vol. 93, pp. 705–18.
- [9] U. Batra, S. Ray, and S. R. Prabhakar, "Austempering and Austempered Ductile Iron Microstructure in Copper Alloyed Ductile iron," *J. Mater. Eng. Perf.*, 2003, vol. 112, pp. 426–29.
- [10] U. Seker, and H. Hasirci, "Evaluation of machinability of austempered ductile irons in terms of cutting forces and surface quality," *J. Mater. Process. Technol.*, 2006, vol. 173, pp. 260–268.
- [11] Klocke F. and Klöpper C., *Machining of ADI* WZL- Laboratory of Machine Tools and Production Engineering: University of Technology, Aachen, Germany.
- [12] F. Zanardi, "Fatigue Properties and Machinability of ADI," *Lametalurgia Italiana*, 2005, vol. 10, pp. 27–32.
- [13] Kristin Brandenburg, *Successfully Machining Austempered Ductile Iron*, Applied process Inc. Technologies, Div.-Livonia, Michigan, USA, October 2001.
- [14] B. Avishan, S. Yazdani, and D. J. Jalali, "Effect of austempering temperature on machinability of Cu-Ni-Mo alloyed austempered ductile iron for heavy section parts," *International Journal of Cast Metals Research*, 2011, vol. 24, pp. 22–27.
- [15] O. Eric, L. Sidjanin, Z. Miskovic, S. Zec, and M. T. Jovanovic, "Microstructure and toughness of CuNiMo austempered ductile iron," *J. Mater. Lett.*, 2004, vol. 58, pp. 2707–2711.
- [16] R. C. Voigt, and C. R. Loper, "Austempered ductile iron process control and quality assurance," *J. Heat Treat.*, 1984, vol. 3, pp. 291–309.
- [17] D. J. Moore, T. N. Rouns and K. B. Roundman: *J. Heat. Treat*, 1985, vol. 9, pp. 7–23.
- [18] M. C. Cakir, A. Bayram, Y. Isik and B. Salar, "The effects of austempering temperature and time onto the machinability of austempered ductile iron," *Mater. Sci. Eng. A*, 2005, vol. 407, pp. 147–153.
- [19] M. Bahmani, and R. Elliott, "The austempering kinetics and mechanical properties of an austempered Cu-Ni-Mo-Mn alloyed ductile iron," *J. Mater. Sci.*, 1997, vol. 32, pp. 4783–4791.
- [20] P. P. Rao, and S. K. Putatunda, "Influence of microstructure on fracture toughness of austempered ductile cast iron," *Metall. Mater. Trans. A*, 1997, vol. 28, pp. 1457–1470.
- [21] B. D. Cullity, *Elements of X-ray Diffraction*, Addison Wesley Publishing Company, 1956, pp. 390–396.
- [22] T. H. Holloman, "Tensile Deformations," *Trans Metal Soc. AIME*, 1945, vol. 162, pp. 268.
- [23] Westermann Tables, pp. 95-96, Wiley Eastern Ltd., New Delhi, India, 1992.
- [24] K.H.W. Seah, and S. C. Sharma, "Machinability of alloyed austempered ductile iron," *Int. J. Mach. Tool Manufact.*, 1995, vol. 35, pp. 1475–1479.
- [25] Z. Zhongkui, S. Quingzhou, M. Hailong, and Z. Junxian, "8<sup>th</sup> Int. Symp. on Science and processing of cast iron," Beijing, China, October 2006, 464–467.
- [26] B. Avishan, S. Yazdani, and D. Jalali Vahid, "The influence of depth of cut on the machinability of an alloyed austempered ductile iron," *Mater. Sci. Eng. A*, 2009, vol. 523, pp. 93–98.
- [27] S. Yazdani, and R. Elliott, "Mater. Sci. Technol.", 1999, vol. 15, pp. 531–540.

**Jagmohan Datt**, Assistant Professor in Department of Materials and Metallurgical Engineering at PEC University of Technology, Chandigarh is a researching PhD scholar. He graduated in Metallurgical Engineering in 1997 from Punjab Engineering College, Chandigarh. In 2001 completed his post-graduation in Industrial Materials and Metallurgy from Panjab University, Chandigarh, India.

**Uma Batra** was born at Chandigarh, India, on July 28, 1964. She graduated with University Gold Medal in Metallurgical Engineering from Punjab Engineering College, Chandigarh, in 1986 and did her post-graduation in Metallurgical Engineering from IIT, Kanpur. She did Ph.D. on the development of Austempered Ductile Iron. She joined Punjab Engineering College as regular faculty in 1989. Presently she is Professor and Head in Materials and Metallurgical Engineering Department and Dean Research Planning and Development in PEC Univ. of Technology, Chandigarh. She was officially nominated as a woman engineer representative to the U.S. Society of Women Engineers by American Society of Engineering Education. She has 20 years of teaching and research experience in the field of Biomaterial Engineering, Structure-Property Correlation of various materials. She has 55 research publications in various journals of repute.