

# Analysis on Influence of Gravity on Convection Heat Transfer in Manned Spacecraft during Terrestrial Test

Wang Jing, Tao Tao, Li Xiyuan, Pei Yifei

**Abstract**—How to simulate experimentally the air flow and heat transfer under microgravity on the ground is important, which has not been completely solved so far. Influence of gravity on air natural convection results in convection heat transfer on ground difference from that on orbit. In order to obtain air temperature and velocity deviations of manned spacecraft during terrestrial thermal test, dimensionless number analysis and numerical simulation analysis are performed. The calculated temperature distribution and velocity distribution of the horizontal test cases are compared to the vertical cases. The results show that the influence of gravity is neglected for facility drawer racks and more obvious for vertical cabins.

**Keywords**—Gravity, Convection heat transfer, Manned spacecraft, Dimensionless number, Numerical simulation

## I. INTRODUCTION

**T**HERMAL test is key process for spacecraft design, manufacture and verification[1]. How to simulate experimentally the flow and heat transfer under microgravity on the ground is important, which has not been completely solved so far. Influence of gravity on air natural convection results in convection heat transfer on ground difference from that on orbit. Mixed convection problem with air flows in enclosures are encountered in a variety of engineering applications [2], [3], [4]. Air flow and heat transfer in rectangular or square cabins driven by buoyancy and shear have been studied extensively in the literature [5], [6], [7]. In view of the results, the ratio  $Gr/Re^2$  indicates the relative strength of the natural and forced convection mechanisms. The dimensionless numbers, Reynolds number  $Re$  and Grashof number  $Gr$  are given by

$$Re = \frac{u_0 L}{\nu} \quad (1)$$

with

- $u_0$  mean flow velocity, m/s;
- $\nu$  kinematic viscosity,  $m^2/s$ ;
- $L$  characteristic length, m.

$$Gr = \frac{gL^3\beta\Delta T}{\nu^2} \quad (2)$$

with

- $g$  gravitational acceleration,  $m^2/s$ ;
- $\beta$  coefficient of thermal expansion,  $1/K$ ;
- $\Delta T$  temperature difference between air and wall, K.

The ratio of the buoyancy forces and the inertial forces is expressed as

$$Gr/Re^2 = \frac{g\beta L\Delta T}{u_0^2} \quad (3)$$

For  $Gr/Re^2 < 0.1$ , the flow and heat transfer is dominated by forced convection, for  $Gr/Re^2 > 10$ , it is dominated by natural convection, and for  $0.1 \leq Gr/Re^2 \leq 10$ , it is a mixed regime.

Based on the above observations, the pressure-reducing method is usually used to suppress the effect of natural convection in manned spacecraft pressured cabins during terrestrial tests in China [8], [9], [10].

The integrated space station is huge in size, thus terrestrial thermal test for it can't be performed in space environmental simulator. The thermal test for full size space station should be performed under atmospheric pressure, and therefore can't lower pressure in cabins. Influence of gravity on air natural convection results in convection heat transfer on ground difference from that on orbit.

The objective of the present study is to obtain air temperature and velocity deviations of manned spacecraft during terrestrial thermal test. The dimensionless number analysis can obtain qualitative error approximately [11], [12]. The numerical simulation analysis can obtain quantitative deviations accurately [13], [14]. Both of the two methods of air convection flow and heat transfer in a manned spacecraft have been carried out.

The effect of the Reynolds number and the buoyancy parameter on the heat transfer is presented and discussed. It is found that the influence of gravity on air convection heat transfer is neglected for facility drawer racks.

Three-dimensional simulation model of a pressured cabin is generated. The simulation model includes conduction and convection heat transfer effects. The results of numerical studies are used to demonstrate thermal tests for manned spacecraft.

## II. DIMENSIONLESS NUMBER ANALYSIS

### A. Analysis Objective

The configuration is analyzed by completing parametric studies to investigate the effect of the following: gap between the drawer surfaces, air flow velocity and temperature difference in cabins.

### B. Facility Drawer Racks

The facility drawer racks provide accommodations and facilitate operations for research payloads. The electronic units are integrated as many drawers in the rack. Cold air flows through these drawers to reduce the temperature inside the rack.

Each typical drawer is of cubic shape with the external configuration of 600mm X 400mm X 150mm. There is a gap between the drawer surfaces for air flow (Figure 1).

Wang Jing is with the Beijing Institute of Spacecraft Environment Engineering, Science and Technology on Reliability and Environmental Engineering Laboratory, P.O. Box 5142-53, Beijing 100094, China (Phone: 086-10-68746283; Email: wangjing19800510@gmail.com).

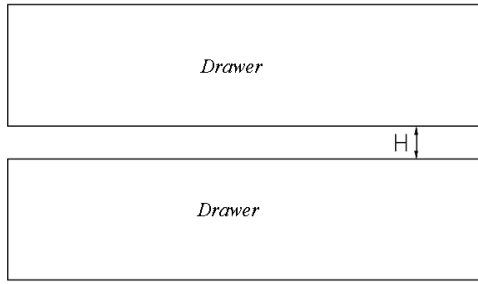

Fig. 1 Gap between the drawer surfaces

The hydraulic diameter of the rectangular channels between drawers is given by

$$D_e = \frac{4A_c}{P} \quad (4)$$

with

- $D_e$  hydraulic diameter, m;
- $A_c$  flow channel section area,  $m^2$ ;
- $P$  flow channel perimeter, m.

It is assumed that the drawer surface temperature is  $30^\circ C$  and the air temperature is  $20^\circ C$ . Fig. 2 shows the ratio  $Gr/Re^2$  for air inside the facility rack as the air velocity is  $0.3m/s \sim 0.5m/s$  and the gap is  $30mm \sim 50mm$ .

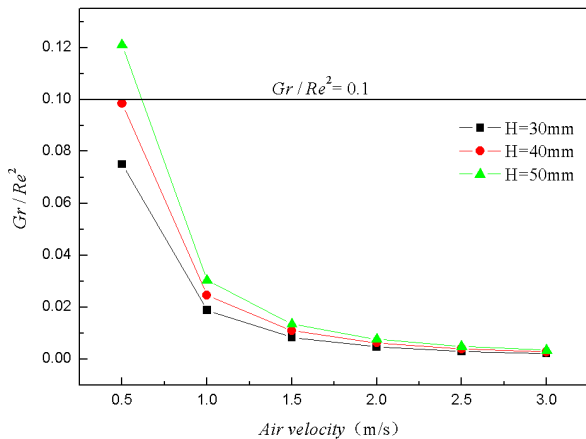

Fig. 2  $Gr/Re^2$  of air flow in facility drawer racks

For most cases, the ratio  $Gr/Re^2 \ll 0.1$  which identifies forced convection dominated regime. As a result, the influence of gravity on air convection heat transfer is neglected for facility drawer racks.

### C. Manned Cabin

The manned cabin provides comfortable condition for astronauts by cold air flow (Figure 3). A typical section of cabin is  $2m \times 2m$ . The air velocity less than  $0.5m/s$  in most manned area. The maximum velocity is  $0.8m/s$  which exist nearby the air flow inlet.

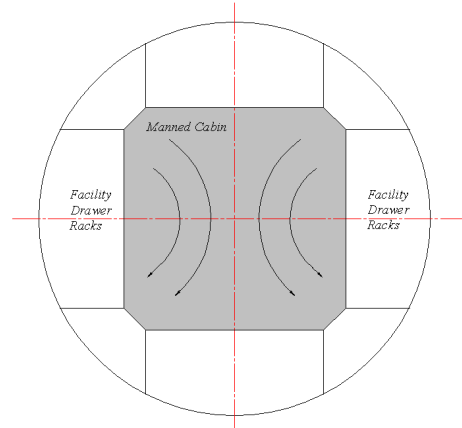

Fig. 3 Manned cabins of space station

It is assumed that the air temperature is  $21^\circ C$  with maximum velocity and the characteristic length is  $2m$ . Fig. 4 shows the ratio  $Gr/Re^2$  for air inside manned cabin as the temperature difference between air and wall is  $3^\circ C \sim 18^\circ C$ .

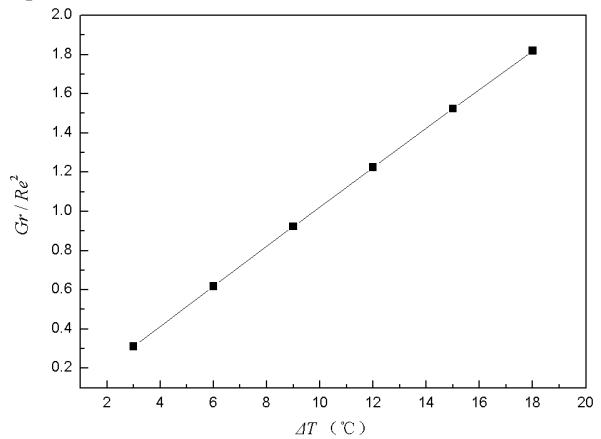

Fig. 4  $Gr/Re^2$  of air flow in manned cabin

Even for maximum air velocity, the ratio  $Gr/Re^2 > 0.1$  for most area inside manned cabin which identifies natural convection dominated regime. As a result, the influence of gravity on air convection heat transfer is obvious for manned cabins.

### D. Heat Transfer Error Analysis

This section will analyze the error of heat transfer between air and wall in the manned cabin. The local Nusselt number ( $Nu_x$ ) can be determined as

$$Nu_x = \frac{h_x L}{\lambda_x} \quad (5)$$

with

- $Nu_x$  local Nusselt number;
- $\lambda_x$  local thermal conductivity,  $W/m^\circ C$ .

Heat transfer in manned cabins during terrestrial tests which natural and forced convection mechanisms interact are mixed convection. Therefore, depending upon the relative magnitude of these two forces, the heat transfer of air flow can be determined as

$$Nu_x = (Nu_F^3 \pm Nu_N^3)^{1/3} \quad (6)$$

with

$Nu_F$  forced convection Nusselt number;  
 $Nu_N$  natural convection Nusselt number.

It is assumed that air inlet is on top of the vertical wall and flow out the cabin from the bottom of wall. Therefore, there are several vortexes on the vertical wall surfaces. As a result, the local flow direction which near the vertical wall is upward. Above expression denotes the sum of two Nusselt number.

Space station is a combination with several cabins which are ventilated within each other. Air flow around the node cabin is turbulent flow.

For laminar flow regions, the local force convection Nusselt number can be determined as [15]

$$Nu_F = 0.680Re^{1/2}Pr^{1/3} \quad (Re < 3 \times 10^5) \quad (7)$$

with

$Pr$  Prandtl number.

For turbulent flow regions, the local forced convection Nusselt number can be determined as [15]

$$Nu_F = 0.296Re^{4/5}Pr^{1/3} \quad (Re < 10^7) \quad (8)$$

For pure natural convection on vertical wall, the average values of Nusselt number can be calculated as [15]

$$Nu_N = 0.68 + \frac{0.67Ra^{1/4}}{[1 + (0.492/Pr)^{9/16}]^{4/9}} \quad (9)$$

with

$Ra$  Rayleigh number,  $Ra = Gr * Pr$ .

In order to verifying heat transfer deviations of manned cabins on ground thermal test with that on orbit, the local heat transfer error can be calculated as [9]

$$E_r = \frac{Nu - Nu_F}{Nu_F} = \left[ 1 + \left( \frac{Nu_N}{Nu_F} \right)^3 \right]^{1/3} \quad (10)$$

It indicates the influence of gravity on air convection heat transfer is neglected when  $E_r \leq 10\%$ . As a result,  $Nu_N/Nu_F \leq 0.7$ .

Fig. 5~7 show the ratio  $Nu_N/Nu_F$  for a 2m X 2m cabin with various air velocity and temperature difference between air and wall  $\Delta T$ .

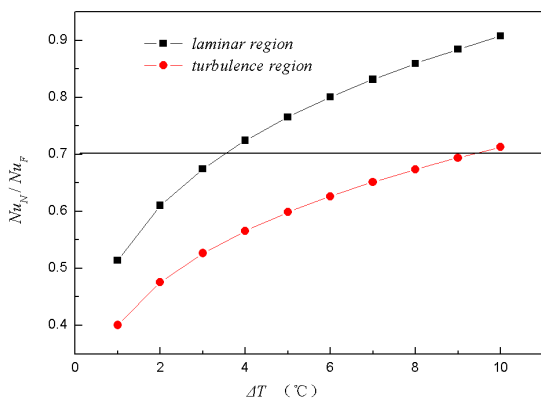

Fig. 5  $Nu_N/Nu_F$  of air flow with 0.6m/s velocity

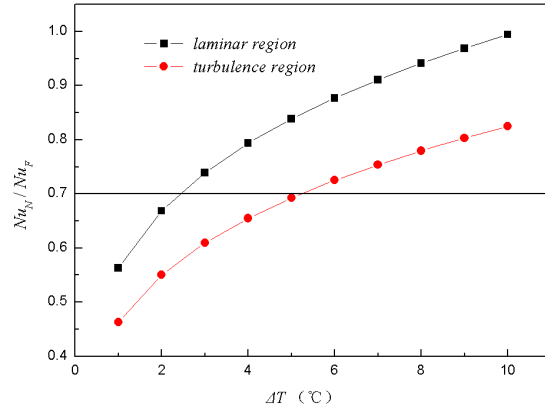

Fig. 6  $Nu_N/Nu_F$  of air flow with 0.5m/s velocity

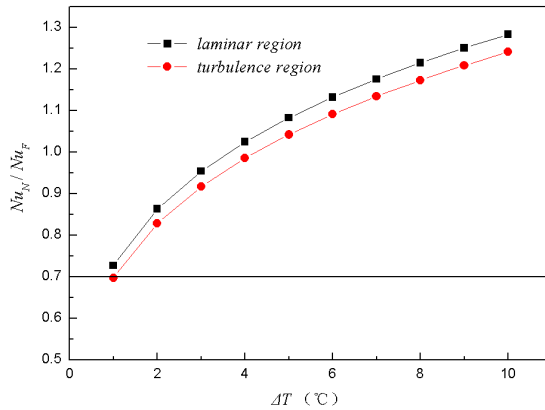

Fig. 7  $Nu_N/Nu_F$  of air flow with 0.3m/s velocity

These figures reveal conclusions as follow:

- 1) In laminar flow region: When the air velocity is more than 0.5m/s and the temperature difference is less than 5°C, convection heat transfer error can be neglected.
- 2) In turbulent flow region: When the air velocity is more than 0.5m/s and the temperature difference is less than 3°C, convection heat transfer error can be neglected.
- 3) In all regions: When the air velocity is less than 0.3m/s, convection heat transfer error is significant.

### III. NUMERICAL SIMULATION ANALYSIS

#### A. Analysis Objective

The qualitative error of convection heat transfer has obtained by means of dimensionless number analysis. A numerical simulation analysis is adopted to acquire quantitative deviations of air temperature and velocity in ground test cases.

#### B. Mathematical Modeling

It is assumed that the air flow is three-dimensional, steady state, turbulent flow and the fluid is incompressible. The thermophysical properties of the air at a reference temperature are assumed to be constant, except in the buoyancy term of the momentum equation, i.e., the Boussinesq approximation. It is further assumed that radiation heat transfer among sides is negligible with respect to other modes of heat transfer.

In the light of assumptions mentioned above, the continuity, momentum and energy equations can be written as follows:

$$\frac{\partial \rho}{\partial t} + \nabla \cdot (\rho V) = 0 \tag{11}$$

$$\frac{\partial (\rho u)}{\partial t} + \nabla \cdot (\rho u V) = -\frac{\partial p}{\partial x} + \rho f_x \tag{12}$$

$$\frac{\partial (\rho v)}{\partial t} + \nabla \cdot (\rho v V) = -\frac{\partial p}{\partial y} + \rho f_y \tag{13}$$

$$\frac{\partial (\rho w)}{\partial t} + \nabla \cdot (\rho w V) = -\frac{\partial p}{\partial z} + \rho f_z \tag{14}$$

$$\frac{\partial}{\partial t} [\rho(e + \frac{v^2}{2})] + \nabla \cdot [\rho(e + \frac{v^2}{2})V] = \rho \dot{q} - \frac{\partial (up)}{\partial x} - \frac{\partial (vp)}{\partial y} - \frac{\partial (wp)}{\partial z} + \rho f \cdot V \tag{15}$$

The turbulent equation with RNG *k-ε* model :

$$\frac{\partial}{\partial t} (\rho k) + \frac{\partial}{\partial x_i} (\rho k u_i) = \frac{\partial}{\partial x_j} (a_k u_{eff} \frac{\partial k}{\partial x_j}) + G_k - G_b - \rho \epsilon - Y_M + S_k \tag{16}$$

$$\frac{\partial}{\partial t} (\rho \epsilon) + \frac{\partial}{\partial x_i} (\rho \epsilon u_i) = \frac{\partial}{\partial x_j} (a_\epsilon u_{eff} \frac{\partial \epsilon}{\partial x_j}) + C_{1\epsilon} \frac{\epsilon}{k} (G_k + C_{3\epsilon} G_b) - C_{2\epsilon} \rho \frac{\epsilon^2}{k} - R_\epsilon + S_\epsilon \tag{17}$$

with

- $\rho$  air density;
- $p$  pressure;
- $u, v, w$  air velocity on  $x, y, z$  direction respectively;
- $k, \epsilon$  diffusivity and turbulent kinetic energy.

*C. Numerical Methods*

A finite-volume numerical solution technique based on integration over the control volume is used to solve the model equations subject to the appropriate boundary conditions. In this solution algorithm, the governing equations are solved sequentially. The convection terms in the governing equations are modeled with the secondary-order upwind scheme which uses the upstream value and gradient to compute the value at the control volume face. The diffusion terms are central-differenced and second-order accurate. The solution algorithm is based on Simple solver to resolve the coupling between velocity and pressure.

Fig.8 shows the manned spacecraft geometry model which is a combination with manned cabin and node cabin. Fig.9 shows gridding model of spacecraft. The grid number of combination is 1.1 million. ANSYS as a commercial software is utilized to modeling, gridding, solution and post-treatment.

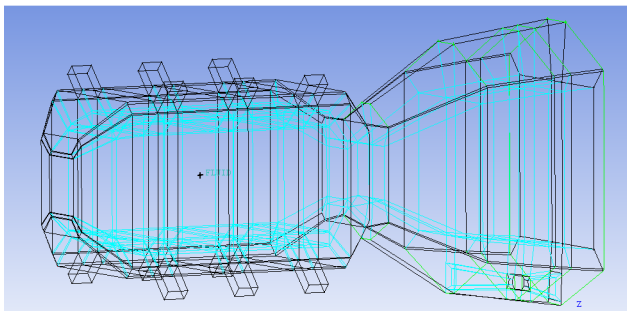

Fig. 8 Geometry model of manned spacecraft

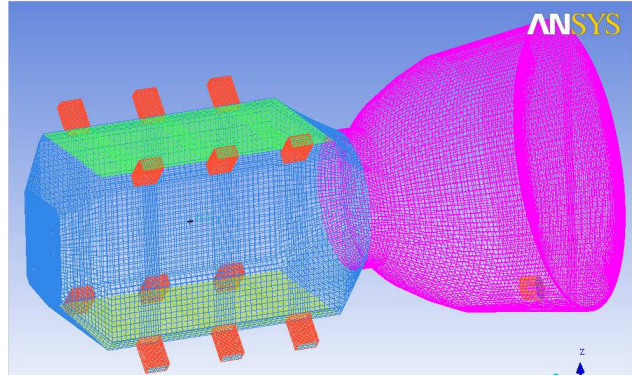

Fig. 9 Gridding model of manned spacecraft

*D. Numerical Simulation Results*

To research the influence of gravity on convection heat transfer, 16 simulation cases are calculated (Table I) which include 8 horizontal test cases and 8 vertical test cases.

TABLE I  
SIMULATION CASES

Case No.	Air Velocity at Inlet, m/s	Air Temp. at Inlet, °C	Boundary Condition	Cabin Orientation
1	0.3	17°C	Wall Tem. 28°C	Horizontal
2	0.5	17°C	Wall Tem. 28°C	Horizontal
3	0.8	17°C	Wall Tem. 28°C	Horizontal
4	1	17°C	Wall Tem. 28°C	Horizontal
5	0.3	17°C	Wall Heat Flux 150W	Horizontal
6	0.5	17°C	Wall Heat Flux 150W	Horizontal
7	0.8	17°C	Wall Heat Flux 150W	Horizontal
8	1	17°C	Wall Heat Flux 150W	Horizontal
9	0.3	17°C	Wall Tem. 28°C	Vertical
10	0.5	17°C	Wall Tem. 28°C	Vertical
11	0.8	17°C	Wall Tem. 28°C	Vertical
12	1	17°C	Wall Tem. 28°C	Vertical
13	0.3	17°C	Wall Heat Flux 150W	Vertical
14	0.5	17°C	Wall Heat Flux 150W	Vertical
15	0.8	17°C	Wall Heat Flux 150W	Vertical
16	1	17°C	Wall Heat Flux 150W	Vertical

The numerical results of the present analyses in horizontal case are compared to the vertical results. To promote the effects of natural convection, the constant heat flux and various mass flows are investigated. The calculated results of temperature distribution and velocity distribution are obtained. Fig.10~13 show the air temperature distribution in manned cabin of several cases. Fig.14~17 show the air velocity distribution in manned cabin of several cases.

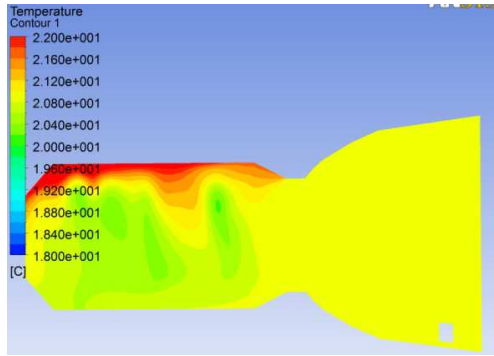

Fig. 10 Temperature Distribution of Case 1

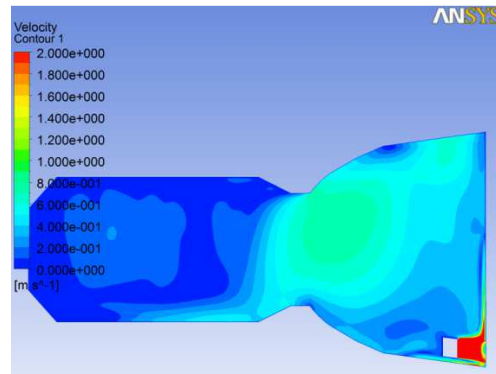

Fig. 14 Velocity Distribution of Case 1

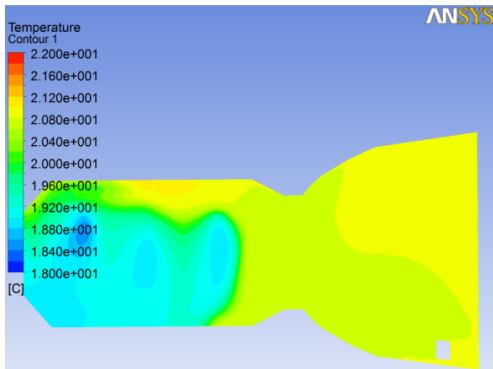

Fig. 11 Temperature Distribution of Case 4

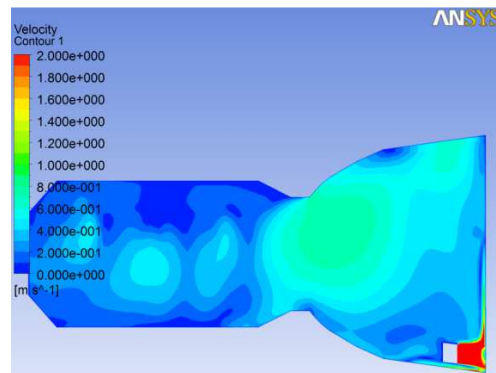

Fig. 15 Velocity Distribution of Case 4

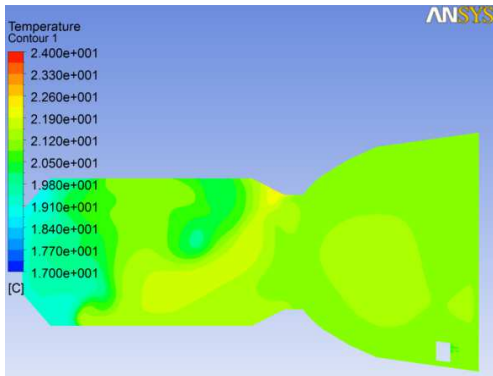

Fig. 12 Temperature Distribution of Case 13

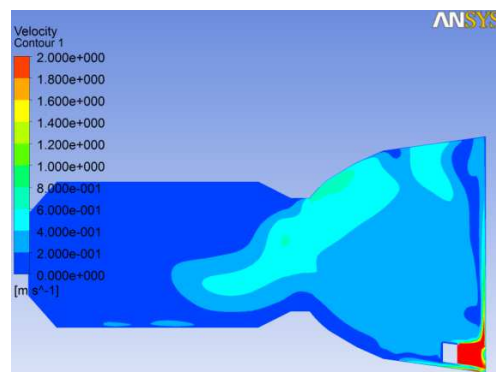

Fig. 16 Velocity Distribution of Case 13

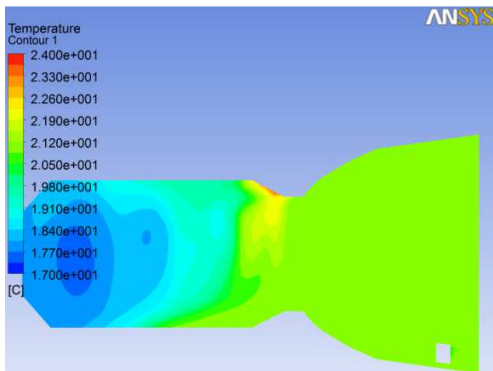

Fig. 13 Temperature Distribution of Case 16

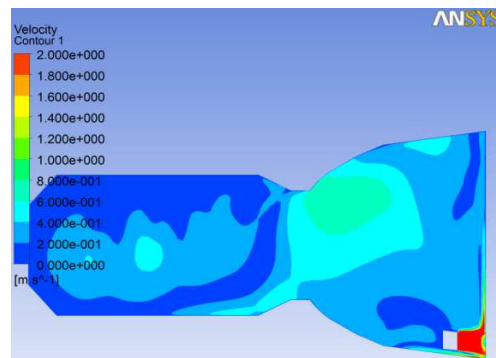

Fig. 17 Velocity Distribution of Case 16

*These results reveal conclusions as follow:*

- 1) The influence of gravity on air temperature distribution is more observable than that on velocity distribution.
- 2) When the spacecraft is horizontal, the maximum temperature difference in manned cabin is about 1°C. When the spacecraft is vertical, the maximum temperature difference in manned cabin is more than 3°C.
- 3) The influence of gravity on air convection heat transfer for vertical case during terrestrial test can't be neglected.

#### IV. CONCLUSIONS

This study has been concerned with air temperature and velocity deviations of manned spacecraft during terrestrial thermal test, dimensionless number analysis and numerical simulation analysis are performed. In view of the results, following findings may be summarized.

- 1) The influence of gravity on air convection heat transfer is neglected for facility drawer racks.
- 2) In manned cabin: When the air velocity is higher than 0.5m/s and the temperature difference between air and wall is less than 3°C, convection heat transfer error can be neglected. Otherwise, convection heat transfer error is significant.
- 3) The influence of gravity on air convection heat transfer for vertical case during terrestrial test is more obvious than that for horizontal cases.

#### REFERENCES

- [1] Huang Ben-cheng, Ma You-li. "Space Environment Test Technology of Spacecraft," Beijing: National Defence Industry Press, 2002.1.
- [2] Hakan F. Oztop, Ihsan Dagtekin. "Mixed Convection in Two-sided Lid-driven Differentially Heated Square Cavity," International Journal of Heat and Mass Transfer, 47, 2004: 1761-1769.
- [3] Michael J. Putten, Maurice H. Putten, Anton F. Putten. "Thermal Flow Measurements at  $Gr/Re^2 \gg 1$  by Silicon Anemometry," IEEE Transactions on Instrumentation and Measurement, 1999, 48(3):724-729
- [4] H.A. Mohammed, Y.K. Salman. "Experimental Investigation of Mixed Convection Heat Transfer for Thermally Developing Flow in a Horizontal Circular Cylinder," Applied Thermal Engineering 27, 2007, 1522-1533.
- [5] Y.S. Tian, T.G. Karayiannis. "Low Turbulence Natural Convection in An Air Filled Square Cavity Part I: The Thermal and Fluid Flow Fields," International Journal of Heat and Mass Transfer, 43, 2000: 849-866.
- [6] Y.S. Tian, T.G. Karayiannis. "Low Turbulence Natural Convection in An Air Filled Square Cavity Part II: The Turbulence Quantities," International Journal of Heat and Mass Transfer, 43, 2000: 867-884.
- [7] Zhang Xue-xue, Liu Jing, Meng Yi. "Ground Test Simulating of Air Heat Convection in Manned Space Capsule," Journal of Tsinghua University (Science and Technology), 1999, 39 (6): 67-70.
- [8] Liang Xin-gang, Guo Zeng-yuan, Liu Yun-long, et al. "Ground-based Technology for Simulation of Ventilative Heat Transfer in Micro-gravity," Science in China, Ser. A, 1997, 27 (11): 1010-1013.
- [9] Huang Jia-rong. "The Suppression of Natural Convection Using Pressure-reducing Method in Vacuum Thermal Balance Test Of Manned Spacecraft," Space Environment Engineering, 2004, 21(1):37-43.
- [10] Zhao Rui, Cheng Wen-long, Liu Qi-nie, et al. "Study on Criterion of Critical Pressure in Spacecrafts Using Lowering Pressure Method," Journal of Astronautics, 2010, 31(2):598-601.
- [11] A. A. M. Delil. "Thermal-Gravitational Modeling and Scaling of Heat Transport Systems for Applications in Different Gravity Environments: Super-Gravity Levels & Oscillating Heat Transfer Devices," NLR-TP-2000-213, 2000.
- [12] Tian Wen-hua. "Similitude Theory and Experimental Investigation in Thermal Scale Model of Spacecraft," AIAA-80-1534.
- [13] Zhong Qi, Liu Qiang. "A Numerical Investigation on Heat Transfer and flow in a pressured cabin of spacecraft," Journal of Astronautics, 2002, 23(5):44-48.
- [14] Xu Xiao-ping, Zhong Qi, Fan Han-lin, Li Jin-dong. "Integrated Flow heat and mass transfer analysis in large spacecraft," Chinese Journal of Space Science, 2004, 24(4):295-301.
- [15] Yang Shi-ming, Tao Wen-quan. "Heat Transfer 4<sup>th</sup> Edition," Higher Education Press, Beijing, 2006.8.

**Wang Jing** received the Ph.D. degree at Beijing University of Aeronautics and Astronautics, China, in 2009. He joined the Beijing Institute of Spacecraft Environment Engineering in 2009 and is now a spacecraft thermal test engineer.