

Modeling of a Novel Dual-Belt Continuously Variable Transmission for Automobiles

Y. Q. Chen, P. K. Wong, Z. C. Xie, H. W. Wu, K. U. Chan, J. and L. Huang

Abstract—It is believed that continuously variable transmission (CVT) will dominate the automotive transmissions in the future. The most popular design is Van Doorne's CVT with single metal pushing V-belt. However, it is only applicable to low power passenger cars because its major limitation is low torque capacity. Therefore, this research studies a novel dual-belt CVT system to overcome the limitation of traditional single-belt CVT, such that it can be applicable to the heavy-duty vehicles. This paper presents the mathematical model of the design and its experimental verification. Experimental and simulated results show that the model developed is valid and the proposed dual-belt CVT can really overcome the traditional limitation of single-belt Van Doorne's CVT.

Keywords—Analytical model, CVT, Dual belts, Torque capacity.

NOMENCLATURE

a	Center-to-center distance (mm)
C_e	Mass of steel element per unit length (kg/m)
C_r	Mass of steel ring per unit length (kg/m)
E_A	Extrusion force at the exit of driving pulley or Extrusion force at the entry of driven pulley (N)
E_p	Extrusion force of steel element on driving pulley (N)
F_A	Tensile force at the exit of driving pulley or Tensile force at the entry of driven pulley (N)
F_{max}	Maximum tensile force of steel belt (N)
F_p	Tensile force of steel ring on driving pulley (N)
F_r	Radial friction between steel element and pulley (N)
F_{re}	Friction between steel ring and steel element (N)
F_t	Tangential friction between steel element and pulley (N)
h	Distance between contact surface and contact edge in steel element (mm)
i	Speed ratio
i_{max}	Maximum speed ratio
i_{min}	Minimum speed ratio
L	Working length of steel belt (mm)
N	Pressure between steel element and pulley (N)
n_p	Speed of driving pulley (r/min)
N_r	Number of layers in steel ring
n_s	Speed of driven pulley (r/min)
P	Pressure between steel ring and steel element (N)
P_1	Power loss due to radial friction between steel element and pulley (kW)
P_2	Power loss due to tangential friction between steel element and pulley (kW)

P_3	Power loss between steel ring and steel element (kW)
Q	Axial force of DBCVT (N)
Q_p	Axial force of driving pulley (N)
Q_s	Axial force of driven pulley (N)
r_{max}	Maximum working radius of pulley (mm)
r_{min}	Minimum working radius of pulley (mm)
r_p	Working radius of driving pulley (mm)
r_s	Working radius of driven pulley (mm)
t	Distance between steel belt and steel element (mm)
T_i	Input torque (N·m)
T_p	Transmission torque (N·m)
V_{ep}	Linear velocity of steel element on driving pulley (m/s)
v_p	Linear velocity of driving pulley (m/s)
V_{rp}	Linear velocity of steel ring on driving pulley (m/s)
V_{rs}	Linear velocity of steel ring on driven pulley (m/s)
v_s	Linear velocity of driven pulley (m/s)
β_{op}	Angle of increase or decrease in E_p (degree)
β_p	Contact angle of driving pulley (degree)
β_s	Contact angle of driven pulley (degree)
γ	Slip angle (degree)
ΔE_p	Extrusion force difference of steel element on driving pulley (N)
ΔF_p	Tensile force difference of steel ring on driving pulley (N)
η	Power efficiency
θ_p	Angle of groove of driving pulley (degree)
θ_s	Angle of groove of driven pulley (degree)
μ_{ep}	Friction coefficient between steel element and pulley
μ_{re}	Friction coefficient between steel ring and steel element
ω_i	Input speed (r/min)
ω_p	Angular velocity of driving pulley (rad/s)
ω_s	Angular velocity of driven pulley (rad/s)

I. INTRODUCTION

CONTINUOUSLY Variable Transmission (CVT) as a type of automatic transmission is now commonly used in automotive applications. In fact, CVT is an ideal design and has many advantages over the other transmissions, such as infinite gear ratios, smoother speed ratio change, simpler mechanism, lighter weight, higher engine efficiency and better fuel economy. Typically, Van Doorne's CVT based on the single metal pushing V-belt is better than the other types of CVTs due to its good reliability, durability and efficiency. Fig. 1 and Fig. 2 show the models of Van Doorne's CVT and metal pushing V-belt. However, its torque capacity is currently limited by the strength of steel belt, and by the ability to withstand friction wear between torque source and transmission medium. Therefore its application is limited to low power passenger cars [1]-[6]. According to the authors' best knowledge, very few research focuses on the area of torque capacity enhancement for Van Doorne's CVT.

Y. Q. CHEN is a PhD student at the Department of Electromechanical Engineering, University of Macau, Macao. (phone: 853-8397-4291; e-mail: yb07418@umac.mo).

P. K. WONG is currently the Head of the Department of Electromechanical Engineering, University of Macau, Macao. (e-mail: fstpkw@umac.mo).

Z. C. XIE is an Assistant Professor at the Department of Electromechanical Engineering, University of Macau, Macao. (e-mail: zxie@umac.mo).

In view of the aforementioned limitations of current single-belt CVT (SBCVT), this paper studies a novel dual-belt continuously variable transmission (DBCVT). Fig. 3 shows the schematic design of DBCVT whose principle likes SBCVT because it consists of two single-belt Van Doorne's CVT systems and a synchronous mechanism. Apparently, there are four pulleys and two steel V-belts, Pulleys 1, 4, 5 and 8 can move transversely and rotate with the shaft synchronously, Pulleys 2, 3, 6 and 7 can rotate with the shafts synchronously. Also, there is a DC servo motor with a shank to push the driving pulleys 4 and 8. A shift fork is set to force the pulleys to move consistently and change the position of pulleys. Meanwhile, the driven pulleys 1 and 5 must synchronize if only the lengths of belts are the same, a synchronous fork can make the pulleys move consistently when the speed ratio is changing. Moreover, the spring is the main component which can decide the axial force. The electronic control unit (ECU) in Fig. 3 receives all the signals which include the position of pulleys, throttle position, input and output shaft speeds and vehicle sed, etc., and then it sends the control signal to drive the DC servo motor. The analytical model, simulated and experimental results of the novel DBCVT are discussed in the following sections.

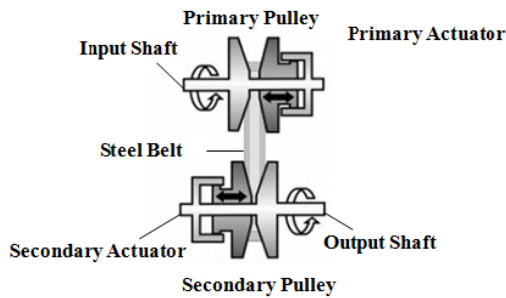

Fig. 1 Model of Van Doorne's CVT

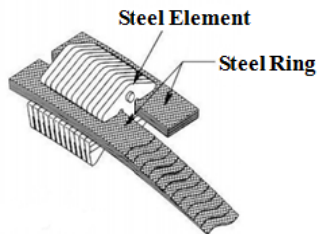

Fig. 2 Model of metal pushing V-belt

II. ANALYTICAL MODEL OF DBCVT

In DBCVT system, the dynamic interactions between two pairs of driving pulleys, two pairs of driven pulleys and two metal pushing V-belts are very complicated. The torque is transmitted by the combined action of tensile force of the steel ring and extrusion force of the steel element. Similar in the existing researches on SBCVT model [3], the analytical model of DBCVT is divided into two cases which are high speed ratio ($i < 1$) and low speed ratio ($i > 1$). In this paper, the following assumptions are made: (1) all pulleys are rigid and no deformation; (2) all characteristics of two combined SBCVT

systems are the same; (3) the lengths of two metal pushing V-belts are constant; (4) all related friction coefficients are constant; (5) the centers of contact arc and the corresponding pulley coincide; (6) the bending and torsional stiffness of the belt are neglected; and (7) the steel ring with layers is treated as a whole one.

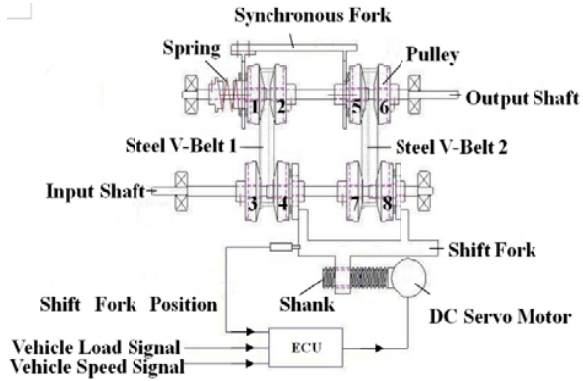

Fig. 3 Schematic design of DBCVT

A. Speed Ratio Equation

Fig. 4 shows the geometrical relationships of DBCVT for the two cases. The speed ratio equation of DBCVT can be expressed as:

$$i = \frac{r_s}{r_p} \tag{1}$$

B. Force Analysis

Due to limited pages, this paper only presents the analytical model of partial steel belt on the driving pulley when DBCVT is operating under low speed ratio. Fig. 6 shows the force diagram of an infinitesimal piece of steel belt.

For steel ring:

The contact angle and the tensile force of the steel ring on the driving pulley can be expressed as:

$$F_p = (F_A - C_r V_{rp}^2) e^{\mu_r \beta} + C_r V_{rp}^2 \quad (0 \leq \beta \leq \beta_p) \tag{2}$$

For steel element:

Set:

$$\mu = \frac{\mu_{ep} \sin \gamma}{\sin \frac{\theta_p}{2} + \mu_{ep} \cos \gamma \cos \frac{\theta_p}{2}} \tag{3}$$

The contact angle and the extrusion force of the steel element on the driving pulley can be expressed as:

$$E_p = \frac{(\mu_{re} + \mu)(F_A - C_r V_{rp}^2)}{\mu_{re} - \mu} (e^{\mu \beta} - e^{-\mu \beta}) + C_e V_{rp}^2 (e^{\mu \beta} - 1) + E_A e^{\mu \beta} \quad (0 \leq \beta \leq \beta_p) \tag{4}$$

Or:

$$E_p = 0 \quad (\beta_{0p} \leq \beta \leq \beta_p) \tag{5}$$

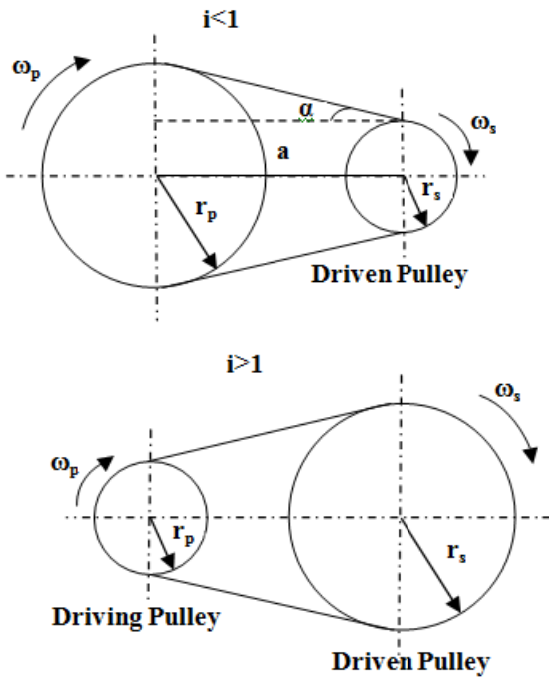

Fig. 4 Geometrical relationships of DBCVT

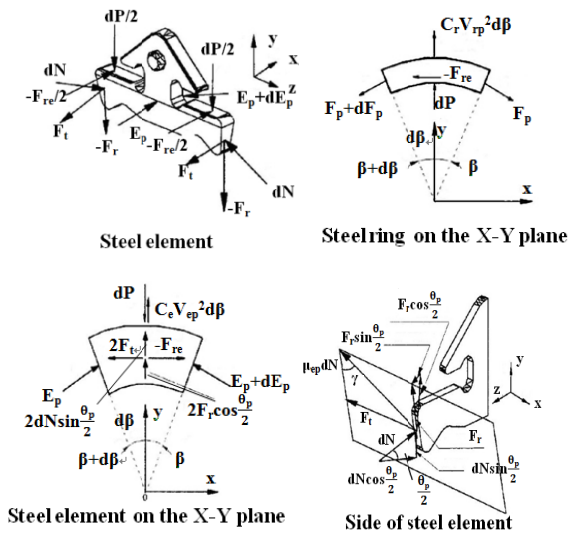

Fig. 5 Force diagram of steel belt on driving pulley ($i > 1$)

C. Transmission Torque

In DBCVT, the tensile force of the steel ring and extrusion force of the steel element will help or resist transmission under different speed ratios and road loads. Again, this paper only presents the available torque for transmission in the input pulley when the vehicle is travelling on a horizontal road or climbing up a hill:

$$T_p = \Delta F_p (r_p + t) + \Delta E_p r_p \tag{6}$$

D. Power Loss

The power loss due to radial friction between the steel element and pulley can be expressed as:

$$P_1 = \frac{n_p r_p \left[(F_A - C_r V_p^2) e^{\mu_r \beta} + C_r V_p^2 - F_A \right] + n_s r_s \left[F_A - (F_A - C_r V_s^2) e^{\mu_r \beta} - C_r V_s^2 \right]}{9549} \tag{7}$$

The power loss due to tangential friction between the steel element and pulley can be expressed as:

$$P_2 = \mu_{ep} (v_p - v_s) \left(\frac{Q_p}{\cos \frac{\theta_p}{2}} + \frac{Q_s}{\cos \frac{\theta_s}{2}} \right) \tag{8}$$

The power loss between the steel ring and steel element can be expressed as:

$$P_3 = v_h \left[\frac{(G_s^2 - N F_A) (N e^{\mu_s \beta} - N)}{N} \left| \frac{l}{r_s} \frac{l}{r_p} \right| + \mu_{es} \alpha \frac{(F_A - C_r V_p^2) e^{\mu_s \beta} + C_r V_p^2 + F_A}{r_s} \right] \tag{9}$$

E. Power Efficiency

The power efficiency of DBCVT is defined as:

$$\eta = \frac{\omega_i T_i - P_1 - P_2 - P_3}{\omega_i T_i} \tag{10}$$

Equations (1)-(10) are useful for DBCVT system stimulation and dynamic analysis. Now, with the analytical model available, it is necessary to validate the model by conducting simulation and experimental study.

III. VALIDATION OF ANALYTICAL DBCVT MODEL UNDER HIGH OR LOW SPEED RATIOS

MATLAB 6.5.1 was selected as the simulation software. The parameters in the simulation model can be modified on the basis of specific DBCVT system.

TABLE I
PARAMETERS OF ANALYTICAL MODEL FOR SIMULATION

a (mm)	C _e (kg/m)	C _r (kg/m)	F _{max} (N)	h (mm)
195	2	0.04	6800	1.5
r _{max} (mm)	r _{min} (mm)	t (mm)	α (°)	γ (°)
45	20	2	11	90
i _{max}	i _{min}	L (mm)	N _r	Q (N)
2.25	0.44	598	12	2000
θ _p (°)	θ _s (°)	μ _{ep}	μ _{es}	
11	11	0.001	0.07	

In order to validate the analytical model and the feasibility of DBCVT system, the simulation of DBCVT system under different speed ratios was conducted. Moreover, a prototype DBCVT was implemented and tested based on the same speed ratios. The parameters used in the simulation test are shown in Table I where the geometrical and mechanical parameters were obtained from the manufacturer catalogues, handbooks and the prototype DBCVT. Fig. 6 shows the prototype of DBCVT and its test rig. Fig.7 shows the simulated and the experimental

results of DBCVT under low speed ratio ($i=1.46$). Fig. 8 shows the simulated and the experimental results of DBCVT under high speed ratio ($i=0.74$). By comparing the simulated results with experimental results in Fig. 7 and Fig. 8, it can be observed that no matter whether the speed ratio is high or low, the experimental data almost agree with the simulated data, which actually verifies the correctness and effectiveness of the proposed model. After verifying the analytical model, two simulation tests of SBCVT under the same speed ratios were done in order to make a performance comparison with DBCVT. Fig. 9 shows the simulated results of SBCVT under $i=1.46$ and $i=0.74$. By comparing Fig. 7(a) and Fig. 8(a) with Fig. 9(a)&(b) respectively, it is also noted that when $i=1.46$ or $i=0.74$, the power efficiency of SBCVT tends to drop at higher torque and higher speeds, at which the slip between the pulley and belt is relatively high, resulting in lower efficiency. However, DBCVT has a higher torque capacity than SBCVT due to higher slip limit, so the power efficiency of DBCVT is better.



Fig. 6 Prototype of DBCVT and test rig

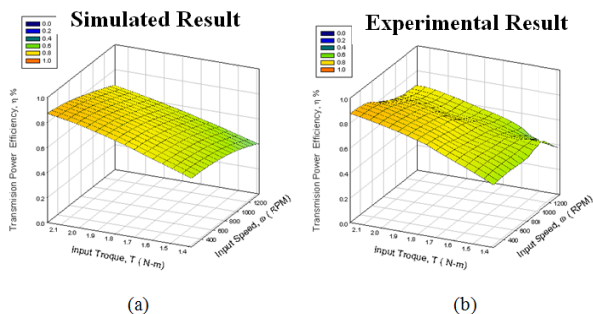

Fig. 7 Simulated and the experimental results of DBCVT under $i=1.46$

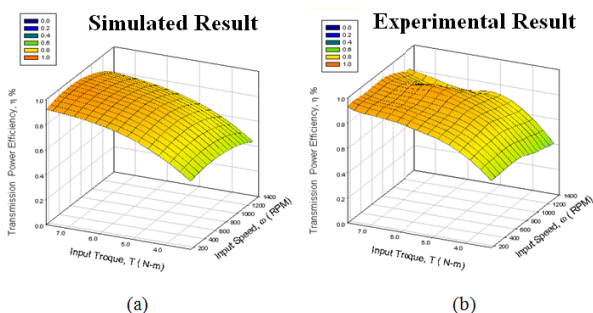

Fig. 8 Simulated and the experimental results of DBCVT under $i=0.74$

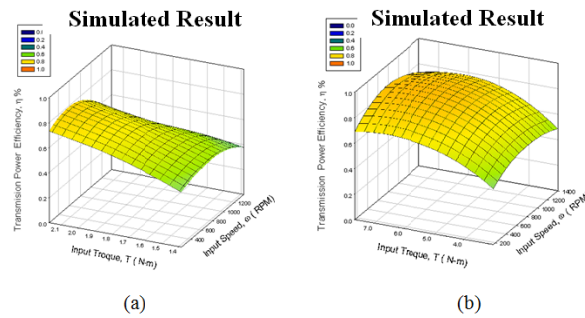

Fig. 9 Simulated results of SBCVT for (a) $i=1.46$ and (b) $i=0.74$

IV. CONCLUSION

Up to now, there is little research on the torque capacity enhancement of Van Doorne's CVT. This paper proposes a novel DBCVT system to overcome the traditional limitations of single belt system and also develops an analytical model of DBCVT by using the geometrical mapping method and spatial analysis.

To verify the analytical model, a prototype DBCVT was successfully built and tested in order to get the experimental data. By comparing the simulated results with the experimental results, they are in a very good agreement, which actually verifies the correctness and effectiveness of the proposed model. One conclusion is that the torque capacity of DBCVT is higher than that of single belt system under the same circumstances, so that it is promising for heavy-duty vehicles. It is also believed that the proposed DBCVT has more advantages over the traditional single belt CVT, but more experiments and analysis should be done in the future.

ACKNOWLEDGEMENT

The research is supported by the University of Macau Research Grant (No. MYRG149 (Y1-L2)-FST11-WPK).

REFERENCES

- [1] K. Adachi, Y. Ochi, and K. Kanai, "Development of CVT control system and its use for fuel-efficient operation of engine," *Asian Journal of Control*, vol. 8, no. 3, pp. 219-226, 2006.
- [2] S. Akehurst, N. Vaughan, D. Parker, and D. Simner, "Modelling of loss mechanisms in a pushing metal V-belt continuously variable transmission. Part 1: torque losses due to band friction," *Proceedings of the Institution of Mechanical Engineers, Part D: Journal of Automobile Engineering*, vol. 218, no. 11, pp. 1269-1281, 2004.
- [3] S. Akehurst, N. Vaughan, D. Parker and D. Simner, "Modelling of loss mechanisms in a pushing metal V-belt continuously variable transmission: Part 2: Pulley deflection losses and total torque loss validation," *Proceedings of the Institution of Mechanical Engineers, Part D: Journal of Automobile Engineering*, vol. 218, no. 11, pp. 1283-1293, 2004.
- [4] S. Akehurst, N. Vaughan, D. Parker and D. Simner, "Modelling of loss mechanisms in a pushing metal V-belt continuously variable transmission. Part 3: belt slip losses," *Proceedings of the Institution of Mechanical Engineers, Part D: Journal of Automobile Engineering*, vol. 218, no. 11, pp. 1295-1306, 2004.
- [5] G. Carbone, L. Mangialardi and G. Mantriota, "The influence of pulley deformations on the shifting mechanism of metal belt CVT," *Journal of Mechanical Design*, vol. 127, no. 1, pp. 103-113, 2005.
- [6] G. Carbone, L. Mangialardi, B. Bonsen, C. Tursi, and P. A. Veenhuizen, "CVT dynamics: Theory and experiments," *Mechanism and Machine Theory*, vol. 42, no. 4, pp. 409-428, 2007.
- [7] K. U. Chan, P. K. Wong, H. W. Wu, "Preliminary Study on Design and

Control of a Novel CVT”, SAE Paper no. 2009-32-0011 and JSAE Paper no. 20097011, 2009.

- [8] J. Micklem, D. Longmore and C. Burrows, “Belt torque loss in a steel V-belt continuously variable transmission,” *Proceedings of the Institution of Mechanical Engineers, Part D: Journal of Automobile Engineering*, vol. 208, no. 2, pp. 91-97, 1994.