

EEG Waves Classifier using Wavelet Transform and Fourier Transform

Maan M. Shaker

Abstract—The electroencephalograph (EEG) signal is one of the most widely signal used in the bioinformatics field due to its rich information about human tasks. In this work EEG waves classification is achieved using the Discrete Wavelet Transform DWT with Fast Fourier Transform (FFT) by adopting the normalized EEG data. The DWT is used as a classifier of the EEG wave's frequencies, while FFT is implemented to visualize the EEG waves in multi-resolution of DWT. Several real EEG data sets (real EEG data for both normal and abnormal persons) have been tested and the results improve the validity of the proposed technique.

Keywords—Bioinformatics, DWT, EEG waves, FFT.

I. INTRODUCTION

ELECTROENCEPHALOGRAPH (EEG) represents complex irregular signals that may provide information about underlying neural activities in the brain [1]. Electroencephalograms are recordings of the tiny electrical potentials (generally less than $300\mu\text{V}$) produced by the brain [2-3].

The brain waves recorded from the scalp have small amplitude of approximately $100\mu\text{V}$. The frequencies of these brain waves range from 0.5 to 100 Hz, and their characteristics are highly dependent on the degree of activity of the cerebral cortex [4]. Generally, in normal persons, the brain waves may be classified as belonging to one of four wave groups. The spectra of these waves are called [3]:

1. The Delta waves which include all the waves in the EEG below 3.5 Hz. They occur in deep sleep, in childhood, and in serious organic brain disease.

2. The Theta waves have frequencies between 4 and 7 Hz. These occur mainly during the childhood, but they also occur during emotional stress in some adults.

3. The Alpha waves are rhythmic waves occurring at a frequency range between 8 and 13 Hz, which are found in all normal persons when they are awake in a quiet, resting state of cerebration.

4. The Beta waves are very low amplitude, and high frequency range between 13 and 30 Hz. They are affected by mental activity.

Many researchers tried to investigate these EEG waves activities recently. Suleiman A.B. R. (2001) proposed a new approach for describing and classifying the EEG brain natural oscillations (delta, theta, alpha, and beta) frequencies using Wigner-Ville analysis with Choi-Willians filtering and Neural Network (NN) [5]. The Wigner-Ville analysis and Choi-

Willians filtering are used for the extraction of the features from each EEG channel, and NN is used as task classifier (these tasks include: open eye, mouse forward, mouse backward and standing). Khidhir A.S. M. (2000) proposed a procedure to study the human state or movement (these states include: open eye, mouse forward, mouse backward, and standing) from EEG signal only [6]. The autocorrelation, wavelets, and Principal Component Analysis (PCA) were the types of the processing used. The Neural Network (NN) is used to recognize the state. The autocorrelation signal is used instead of the signal itself to decrease the complexity of the NN. PCA is used to reduce the dimensionality of the EEG signal. Finally, wavelet analysis is used as a classifier prior to the NN.

The aim of this work is to calculate the EEG waves (delta, theta, alpha, and beta) using Discrete Wavelet Transforms (DWT) followed by discrete Fast Fourier Transform (FFT).

II. THEORETICAL CONCEPTS: DISCRETE WAVELET TRANSFORMS (DWT)

The DWT means choosing subsets of the scales (a) and positions (b) of the wavelet mother $\psi(t)$.

$$\psi_{(a,b)}(t) = 2^{\frac{a}{2}} \psi\left(2^{-\frac{a}{2}}(t-b)\right). \quad (1)$$

Choosing scales and positions are based on powers of two, which are called dyadic scales and positions $\{a_j = 2^{-j}; b_{j,k} = 2^{-j}k\}$ (j and k integers). Equation (1) shows that it is possible to built a wavelet for any function by dilating a function $\psi(t)$ with a coefficient 2^j , and translating the resulting function on a grid whose interval is proportional to 2^{-j} [7].

Contracted (compressed) versions of the wavelet function match the high-frequency components, while dilated (stretched) versions match the low-frequency components. Then, by correlating the original signal with wavelet functions of different sizes, the details of the signal can be obtained at several scales. These correlations with the different wavelet functions can be arranged in a hierarchical scheme called multi-resolution decomposition. The multi-resolution decomposition algorithm separates the signal into "details" at different scales and a coarser representation of the signal named "approximation" [8-10].

The algorithm of the DWT decomposition and reconstruction can be summarized by following procedure:

Dr. Maan M. Shaker is assistance professor in Optoelectronics Engineering, Technical College of Mosul, Mosul, Iraq (e-mail: maanms_56@yahoo.com).

Given a signal "s" of length n. Starting from s, the first step produces two sets of coefficients: approximation coefficients cA1, and detail coefficients cD1. These vectors are obtained by convolving s with the low-pass filter Lo_D for approximation, and with the high-pass filter Hi_D for detail, followed by dyadic decimation. This is shown in Fig. (1.a). The length of each filter is equal to 2N. If n = length (s), the signals F and G are of length n + 2N - 1, and then the coefficients cA1 and cD1 are of length

$$\text{floor}\left(\frac{n-1}{2}\right) + N \quad (2)$$

Floor means that the length of the coefficients rolled to the nearest integer.

The next step splits the approximation coefficients cA1 into two parts using the same scheme, replacing s by cA1 and producing cA2 and cD2 as shown in Fig. (1.b), and so on. So, the wavelet decomposition of the signal s analyzed at level i has the following structure: [cAi, cDi... cD1].

The structure in Fig. 2 contains i= 3, as shown in the terminal of the tree.

Conversely, starting from cAi and cDi, the inverse discrete wavelet transform (IDWT) reconstructs cAi-1, inverting the decomposition step by inserting zeros and convolving the results with the reconstruction filters, as shown in Fig. 3 [8], [10].

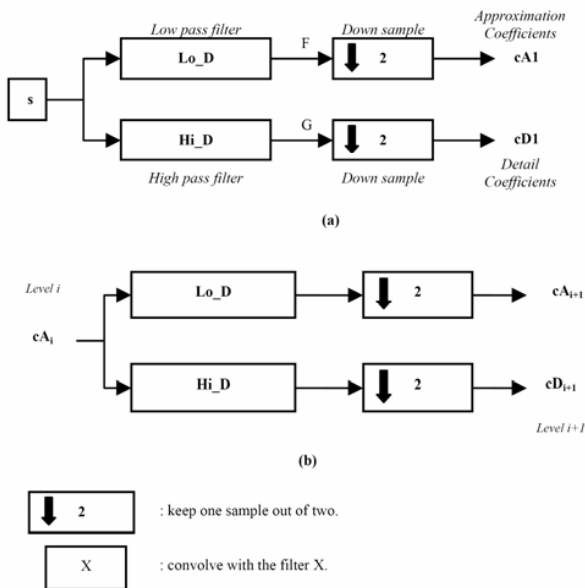

Fig. 1 The algorithm of the DWT, (a) one decomposition of the signal s, (b) decomposition at each level

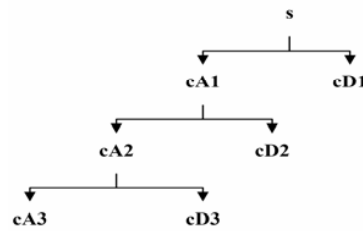

Fig. 2 The tree of the multi-decomposition (multi-level) of the signal s

III. EEG WAVES CLASSIFICATION

The discrete wavelet transform (DWT) has main advantages over many conventional methods in the separation of waves. It provides an optimal resolution in both the time and the frequency domains (i.e., dividing the signals into various multi-level frequencies), and it eliminates the requirement of signal stationary [9].

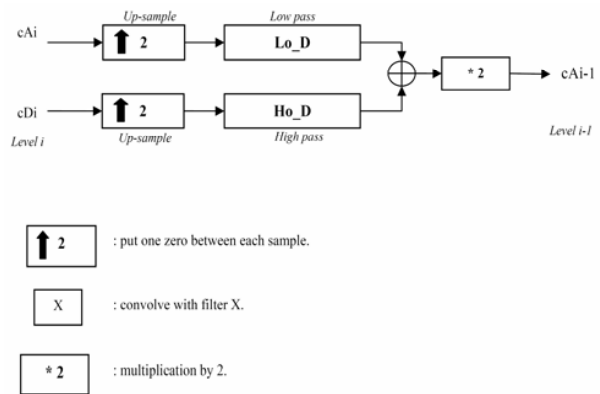

Fig. 3 The algorithm of the IDWT

The proposed approach is summarized in the following steps:

A. Normalizing the Data

Brian waves occur during the activity of brain cells and have frequency range (3-30) Hz [2]. The signal should be normalized prior to any analysis on the EEG waves to reject undesired signals. The normalization is performed by band pass filtering the signal (3–30) Hz (four poles Elliptic filter is used), and then signal amplitude is carefully adjusted.

B. Data Decomposition using DWT

DWT chooses only a subset of scales and positions. DWT works as filters where the signals are divided into two bands at each a specified level called approximations and details signals. The approximations (A) are the high-scale, low-frequency components of the signal. The details (D) are the low-scale, high-frequency components. The samples of the signal are dividing by 2 and this is called sub-sampling, as shown in Fig. 4. The data obtained after normalization stage serves as the input data to the DWT decompositions, which is also known as Sub-band Coding, and could be repeated for further decomposition. At every level, the sub-sampling will

result in half the number of samples. The procedure of the sub-band coding of the EEG data can be visualized [11], as shown in Fig. 5. In this work, a four-level multi-resolution decomposition using Daubechies4 wavelets is implemented. Each level could characterize the frequencies of the EEG data band.

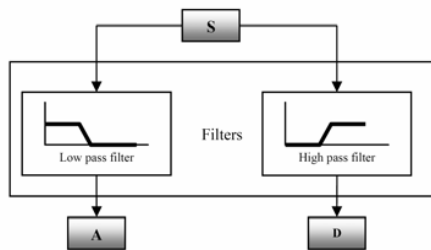

Fig. 4 The filtering process of the DWT

C. Fast Fourier Transform (FFT) of each level in DWT levels:

Fourier analysis is extremely useful for data analysis, as it breaks down a signal into constituent sinusoids of different frequencies. For sampled vector data, Fourier analysis is performed using the discrete Fourier transform (DFT). The fast Fourier transform (FFT) is an efficient algorithm for computing the DFT of a sequence; it is not a separate transform. It is particularly used in area such as signal processing, where its uses range from filtering and frequency analysis to power spectrum estimation [9], [12]. Computation using FFT of each level gives an indication to the frequencies that the bands contained in. Fig. 6 summarizes the flow chart of the EEG waves classification software.

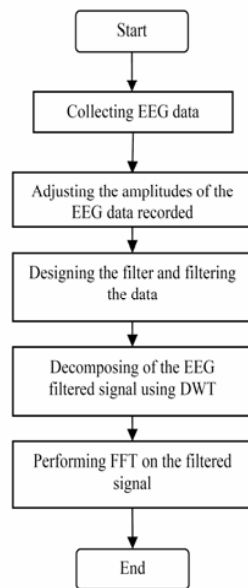

Fig. 6 Flow chart of EEG waves classification procedure.

IV. PRACTICAL RESULTS

The EEG real data were recorded for both normal persons and epilepsy persons. The data were recorded as occipital region “O1” with earlobe “A1” as reference electrode .The data were transferred to the computer using NI-PCI-6023E DAQ, with sampling rate of 12 kHz. The length of each data recorded is 10 sec (i.e. 120000 samples)[13]. Then, the amplitude of EEG data is normalized at (± 1) to be suitable for the analysis.

EEG waves classification contains two main processes: (a) EEG filtering, and (b) decomposition of the filtered signals.

A. EEG Data Filtering

The digital filter used in the EEG waves classification is 4th order pass band Elliptic filter, and the setting of the band pass frequencies is from (3-to-30) Hz. The filtered signals have only EEG waves (delta, theta, alpha, and beta) so this means that undesired frequencies (such as spikes) have been rejected. Fig. 7 shows the EEG data after filtering using the described digital filter. The main feature extracting from this Fig. is that the signals contain low frequencies. Figs. (7.a.1) and (7.b.1) represent the raw data before filtering for both the real data of normal person, and real data of abnormal person, respectively. Figs. (7.a.2) and (7.b.2) represent the filtered data for the same two persons above.

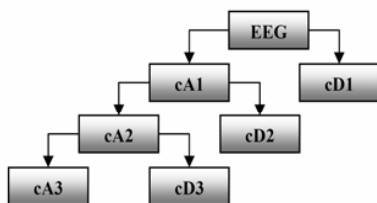

Fig. 5 Sub-band coding algorithm of the DWT

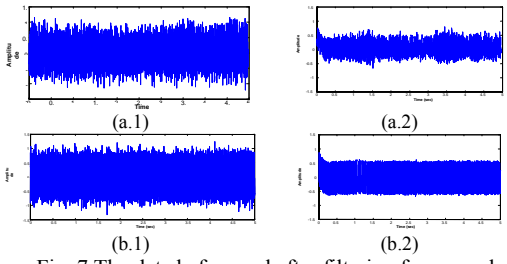

Fig. 7 The data before and after filtering for normal person and abnormal person, where the left column represents the raw data and right column represents the filtered data

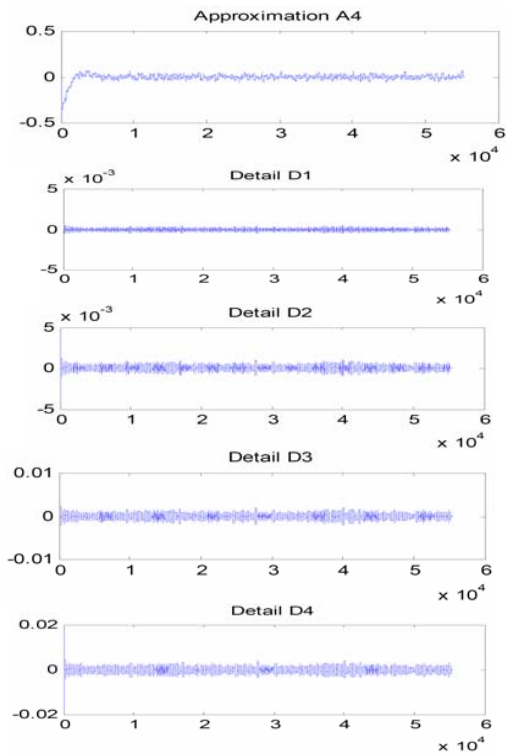

Fig. 8 Multi-level decomposition of real data of normal person

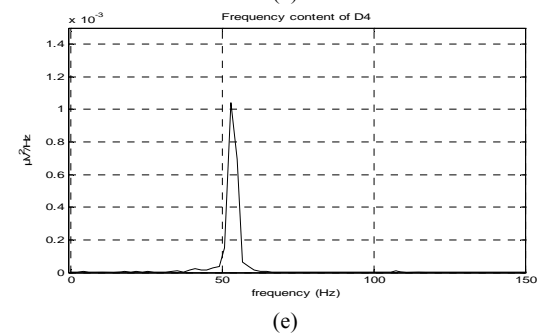
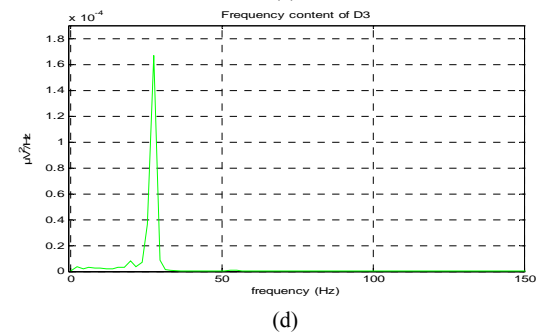
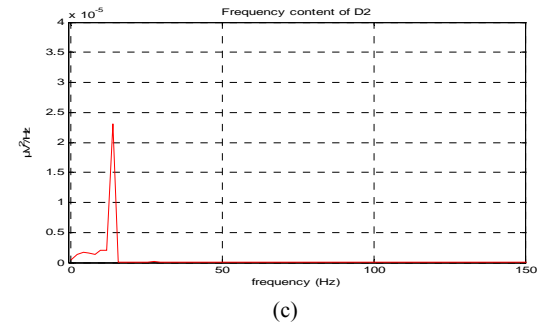
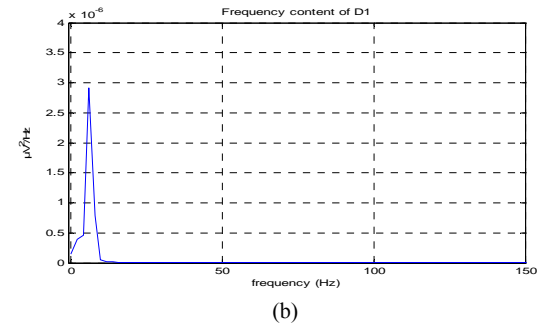
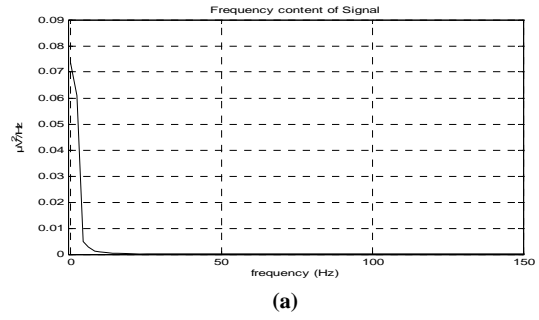

Fig. 10 FFT of each DWT level of real data of normal person

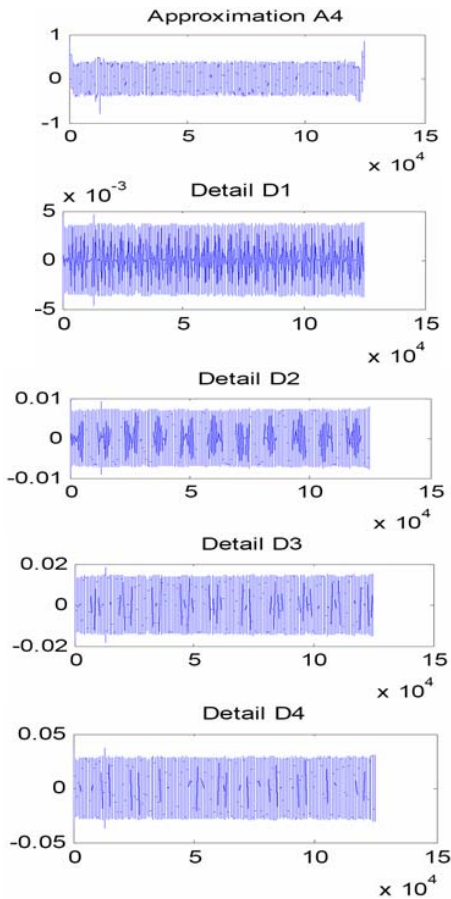

Fig. 9 Multi-level decomposition of real data of abnormal person

B. EEG Data Decomposition and Waves Classification

The filtered data contain the EEG waves; the EEG waves can be extracted by decomposition of the data using multi-level discrete wavelet transform (DWT), where DWT contains sub-band of the signal. Figs. 8 and 9 show the sub-banding of real data of normal person, and real data of abnormal person, respectively. Four levels of DWT using Debauches4 are implemented. The information about the frequencies of the EEG waves is distributed in several wavelet levels. Moreover, wavelet coefficients are localized in time. Finally, to detect the frequency contained in each level, FFT is employed. Figs. 10 and 11 show the results of the applying the FFT for each DWT level of the real data for both normal person and abnormal person. Visually, the EEG waves were calculated from the FFT of each level of DWT. The EEG signal contains all frequencies and every frequency indicates a specific class. The low frequency containing in EEG signal, delta waves can be extracted, as shown in Figs. (10.b) and (11.b). Moreover, an increasing in frequency can be extracted as theta waves in Figs. (10.c) and (11.c). The normal waves (alpha waves) can be extracted in Figs. (10.d) and (11.d). Finally, the high frequencies in EEG signal (beta waves) can be classified, as in Figs. (10.e) and (11.e).

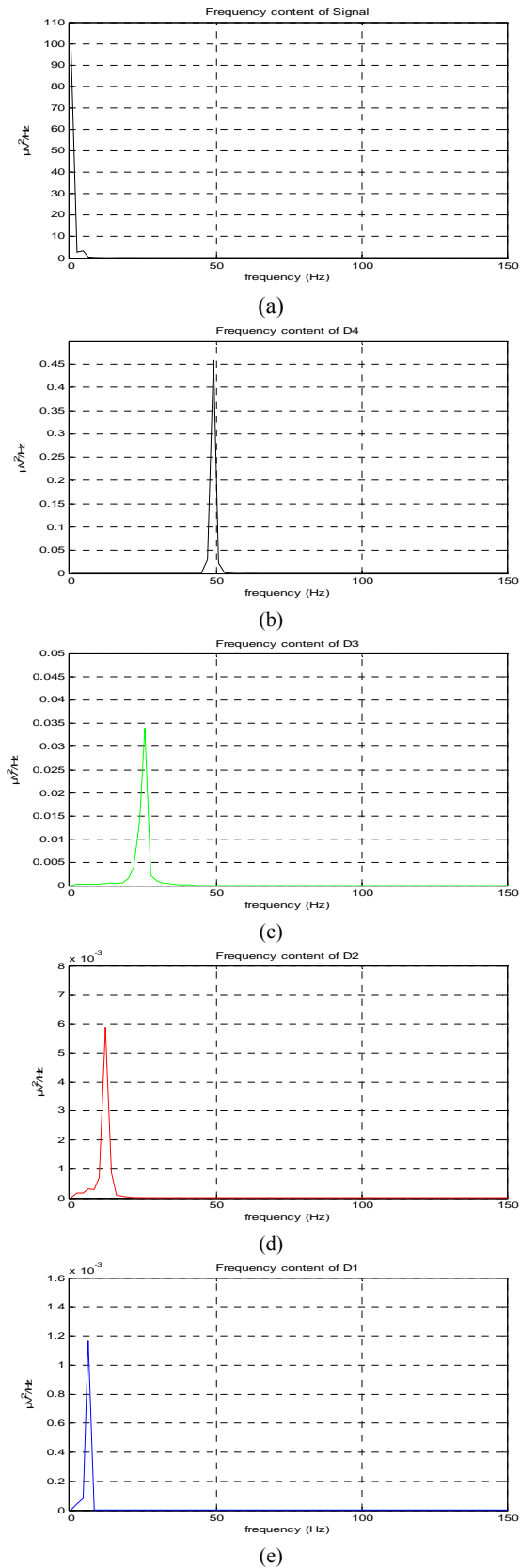

Fig. 11 FFT of each DWT level of real data of abnormal person

V. CONCLUSION

EEG waves classification is achieved using an accurate and highly distinguishable technique. The proposed method makes use of both the discrete wavelet transform as well as the discrete Fourier transform. Specially, wavelet transform is used as a classifier of the EEG frequencies. In addition, the filtered EEG data were used as input to the wavelet transform offers a perfect success in the rejecting undesired frequencies and permits the DWT levels to discriminate the EEG waves only. This method offers more efficiency than previous works, which it can be easily distinguished between EEG waves.

REFERENCES:

- [1] J. Bhattacharya, & H. Petsche, "Universality in the brain while listening to music", Proc. Royal Society Lond. B., No. 268, pp (2423-2433), 2001.
- [2] J.D. Bronzino, "Biomedical Engineering Handbook", Vol. 1, 2nd ed., New York: CRC Press LLC, 2000.
- [3] Webster, J. G., "Medical Instrumentation Application and Design", 2nd ed., New York: Wiley, 1995.
- [4] M. Abeles, & Goldstein M., "Mutispikes Train Analysis", Proc. IEEE, No. 65, pp (762-773), 1977.
- [5] A. R. Sulaiman, "Joint Time-Frequency Analysis and Its Application for Non-Stationary Signals", Ph.D. Thesis, Elect. Eng. Dept., University of Mosul, 2001.
- [6] A. M. Khidhir, "Investigation of using Electroencephalography Signals in Man-Machine Communication System". Ph.D. Thesis. Elect. Eng. Dept., University of Mosul, 2000.
- [7] S.G. Mallat, "A Theory for Multiresolution Signal Decomposition: The Wavelet Representation", IEEE Trans. On Pattern Analysis and Machine Intell., Vol. 2, No. 7, pp: (674-693), 1989.
- [8] R. Quiñan Quiroga, Z. Nadasdy, & Y. Ben-Shaul, "Unsupervised Spike Detection and Sorting with Wavelets and Superparamagnetic Clustering", Neural Computation, No. 16, pp (1661-1687), 2004.
- [9] A. Graps, "Introduction to Wavelets", original paper published by the IEEE Computer Society (1995) Vol. 2 No. 2, 2003.
- [10] M. Misiti, Y. Misiti, G. Oppenheim, & J. Poggi, "Wavelet Toolbox User's Guide", Ver. 2.2, The MathWorks, Inc., 2002.
- [11] M. Akin, O. Erogul, M. Bayram, N. Sezgin, "Determining of Doze Level Analyzing EEG Signals by Using Wavelet Transform and Neural Networks", International XII., TAINN, Vol. I, No. 1, 2003.
- [12] "Statistical Toolbox User's Guide", Ver. 2.2, The MathWorks, Inc., 2004.
- [13] Mazin Z. Othman, Maan M. Shaker, "EEG Spikes Detection, Sorting, and Localization", (Periodical style—Accepted for publication) IV Enformatika conference attended in 28 November 2005.

Dr. Maan M. Shaker received his Electronic and communication Eng. B.Sc., and got his M.Sc. in microprocessor applications from both college of Engineering /Electrical department university of Mosul in 1978 and 1981, respectively. He had his Ph.D. in Optoelectronics Engineering for Warsaw University of Technology/ Boland in 1993. He supervised more than 21 M.Sc. and Ph.D. students. He has published more than 24 papers. His main interest fields are optoelectronic, electronic and communication applications.