

# The Influence of the Commons Structure Modification on the Allocation

Oana Pop, Constantin Barbulescu, Mircea Nemes, and Stefan Kilyeni

**Abstract**—The tracing methods determine the contribution the power system sources have in their supplying. The methods can be used to assess the transmission prices, but also to recover the transmission fixed cost. In this paper is presented the influence of the modification of commons structure has on the specific price of transfer. The operator must make use of a few basic principles about allocation. Most tracing methods are based on the proportional sharing principle. In this paper Kirschen method is used. In order to illustrate this method, the 25-bus test system is used, elaborated within the Electrical Power Engineering Department, from Timisoara, Romania.

**Keywords**—Power systems, P-U bus, P-Q bus, tracing methods.

## I. INTRODUCTION

**K**IRSCHEN method organises the network's buses and branches in homogeneous groups according to the following concepts: the domain of generator, commons and links [1]-[4]. This method is applied independently both for active and reactive power.

The domain of a generator represents a set of buses, which are supplied by the power of that certain generator. The power produced by a generator supplies a particular bus, if there is a path through the network from the generator to that bus and if the direction of power flow is from the generator to the bus. Note that the domain of the generator from the point of view of the active power is not the same as that from the point of view of the reactive power.

The commons of a generator are defined as a set of neighbouring buses supplied by the same generators. The sets of buses that are unconnected with one another, but are supplied by the same generators are treated as separate commons. A bus belongs to only one common. The rank of a common is defined as the number of generators supplying power to the buses included in this common.

Having the buses divided into commons, each branch can be either internal to a common (for example, it connects two buses which are part of the same common) or external (for example, it connects two buses which are part of different commons). A link is made of one or more external branches connecting the same commons. It is very important to note that power flows from all branches of a link are all in the same

direction. Furthermore, this flow from a link is always from a common of rank  $N$  to a common of rank  $M$ , where  $M$  is always greater than  $N$ .

If the commons are represented as buses and branches as links, the state of system can be represented by an *acyclic graphic*. This graphic is direct, because the direction of the flow in a link is specified. It is acyclic because the links can only go from a common supplied by fewer generators to a common supplied by more generators.

Based on the previous information, the Kirschen method determines the contribution of the generators to the loads in a common, as well as the contribution of the generators in individual loads and branch flows.

The results obtained provide only a qualitative view of the transmission system. To obtain quantitative information various definitions and fundamental assumptions are necessary.

The *inflow of a common* is defined as the sum of the power injected by sources located in a common and the power imported in this common by external link. This inflow is always positive. For the root node of the state graph, this includes only the power from the sources in the common.

This assumption provides the basis of a recursive method for determining the contribution of each generator to the load in each common.

To calculate the contribution of each generator in each common, the following notations are used:

$$F_{ijk} = C_{ij} \cdot F_{jk} \quad (1)$$

$$I_k = \sum_j F_{jk} \quad (2)$$

$$C_{ik} = \frac{\sum_j F_{ijk}}{I_k} \quad (3)$$

where:  $C_{ij}$ —the contribution of the  $i$  generator to the load and the outflow of the  $j$  common;  $C_{ik}$ —the contribution of the  $i$  generator to the load and the outflow of the  $k$  common;  $F_{jk}$ —the flow on the link between the  $j$  and  $k$  commons;  $F_{ijk}$ —the flow on the link between the  $j$  and  $k$  commons due to the  $i$  generator;  $I_k$ —the inflow of the  $k$  common.

Unfortunately, the inflow of the root bus of the state graph is produced entirely by the generators embedded in these commons. The proportion of the outflow traceable to each of these generators can be resolved and contained in the commons of higher rank.

Considering that all the buses from a certain common cannot be distinguished one from the other from the point of view of power tracing, then the calculus can be applied for the individual loads too, as well as for the internal links from within each common.

Therefore, if the common to which a bus belongs and the contributions of each generator to each common are known, then this allows us to calculate how much power each generator contributes to each load. It also makes it possible to compute what

Manuscript received March 30, 2008.

O. Pop is with "Politehnica" University of Timisoara, RO 300223 Romania (+40-256-403430; fax: +40-256-403416; e-mail: oana.pop@et.upt.ro).

C. Barbulescu, is with "Politehnica" University of Timisoara, RO300223 Romania (+40-256-403430; fax: +40-256-403416; e-mail: constantin.barbulescu@et.upt.ro).

M. Nemes is with "Politehnica" University of Timisoara, RO 300223 Romania (+40-256-403407; fax: +40-256-403416; e-mail: mircea.nemes@et.upt.ro).

St. Kilyeni, is with "Politehnica" University of Timisoara, RO 300223 Romania (+40-256-403416; fax: +40-256-403416; e-mail: stefan.kilyeni@et.upt.ro).

proportion of the use of each branch can be apportioned to each generator.

It is reasonable to assume that generators contribute to the losses in a branch in proportion to their use of that branch. Therefore, it is possible to compute what proportion of the outputs of the generator is dissipated in system losses.

II. DESCRIPTION OF TEST POWER SYSTEM ANALYZED

The test system used for the analysis has 25 buses and 29 branches. It was created on the south-west side of the National Power System. 6 P-U buses, (the slack bus is bus number 1) and 19 P-Q buses; the voltage level for 2 buses is 400 kV, 8 buses are at 220 kV, 10 buses at 110 kV, one bus at 24 kV, 2 buses at 15 kV and 2 buses at 10 kV. In this particular state of function, 4 consumer buses and 3 P-U buses have zero consume power (these 4 P-Q buses become passive buses), and the source from bus number 6 works as a synchronous compensator (Fig. 1).

Among the 29 branches, 17 are electrical overhead lines (one of 400 kV, 8 of 220 kV and 8 of 110 kV), one is under-ground line, 5 transformers and 6 autotransformers [5].

TABLE I  
CONFIGURATION OF THE P-U AND P-Q BUSES

Nr	Load MW	Gen MW	Nr	Load MW	Gen MW
1	80	711.48	14	237	
2	8	1042.68	15		
3	80	680.85	16		
4		50	17		
5		20	18	120	
6		4	19	32	
7	350		20	22	
8	530		21	20	
9	156		22	35	
10	175		23	12	
11	400		24	58	
12			25	24	
13	170				

TABLE II  
ACTIVE POWER FLOWS ON THE SYSTEM BRANCHES

From bus	To bus	From MW	From bus	To bus	From MW
1	7	631.5	6	13	4
7	9	241.3	11	14	103.7
2	10	1034.7	13	14	133.3
10	8	489.8	23	25	11
7	8	40.2	23	24	58
17	19	23.7	10	15	369.9
17	20	24.5	15	23	81
3	11	600.8	15	16	48
12	11	9.5	22	21	13
11	17	48.2	16	22	48
4	18	50	20	19	8.3
9	12	85.3	18	20	5.8
12	18	75.8	5	21	20
11	13	58.4	21	25	13
15	13	240.9			

The generated and consumed active powers, for the 25 buses test system are synthesized in Table I. Table II presents the active power flows on the branches of the Test 25 buses test power system.

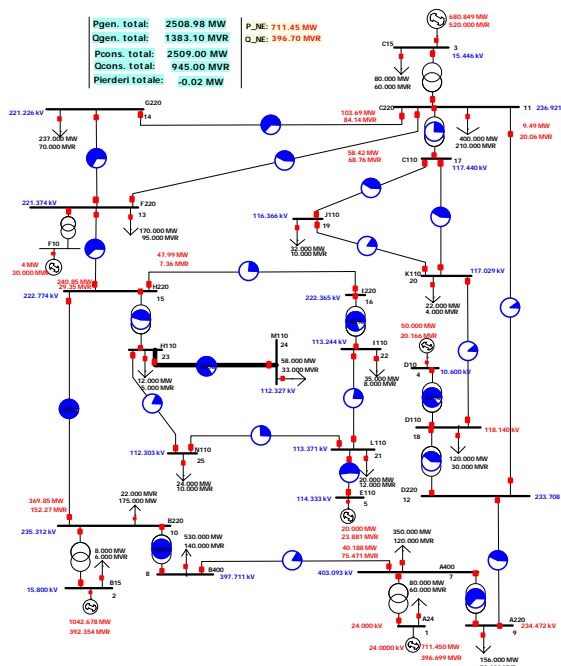

Fig. 1 Configuration of Test 25 buses test power system

III. NUMERICAL SIMULATIONS

For the test system presented in Fig. 1, four application cases of the Kirschen method are analysed. The differences between them are made by choosing different buses to realise the commons analysed. By using these commons, the contribution of each generator in the active power can be computed. The first case is presented in detail, and for the rest, only the generators participation prices in the active power flow will be presented.

A. Case 1

According to the structure of the analyzed test system and to the principles stated above, the commons will be defined as presented in Table III.

TABLE III  
DEFINITIONS OF ANALYZED SYSTEM COMMONS

Nr.	Component bus	Input power [MW]	Output power [MW]
1	1, 7, 9	711.48	586
2	2, 8, 10	1042.68	713
3	3, 11, 19, 20	680.85	134
4	4, 18, 12	50	120
5	5, 15, 16, 21, 22, 23, 24, 25	20	149
6	6, 14, 13	4	407

Table IV contains the definitions of the links between zones.

TABLE IV  
DEFINITIONS OF ANALYZED SYSTEM LINKS

From	To	Branch	Value [MW]
1	2	7_8	40.2
2	5	10_15	369.9
5	6	15_13	240.9
1	4	9_12	85.3
4	3	12_11,18_20	15.3
3	6	11_13, 11_14	162.1

Fig. 2 presents the state graph, which expresses the link between the commons of the analyzed system.

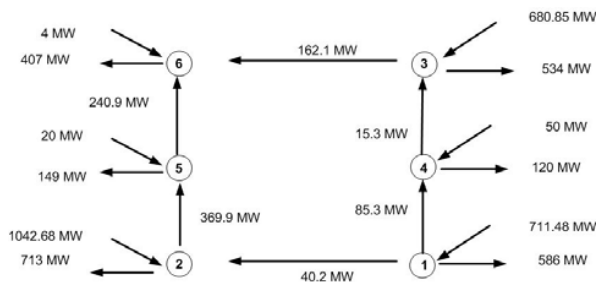

Fig. 2 State graph for case 1

From now on, the contribution of each generator in the load and in the power generated in each common will be computed.

The contributions are calculated starting with the root bus 1:

$$CG_1 = \frac{711.48}{711.48} = 1 p.u. \quad (4)$$

The absolute contribution in the inflow of common 2:

$$CG_1 = 40.2 \cdot 1 = 40.2 MW \quad (5)$$

$$CG_2 = 1042.68 \cdot 1 = 1042.68 MW \quad (6)$$

The relative contribution in the load and outflow of common 2:

$$CG_1 = \frac{40.2}{40.2 + 1042.68} = 0.037123 p.u. \quad (7)$$

$$CG_2 = \frac{1042.68}{40.2 + 1042.68} = 0.962877 p.u. \quad (8)$$

The absolute contribution in the inflow of common 5:

$$CG_1 = 0.037123 \cdot 369.9 = 13.73188 MW \quad (9)$$

$$CG_2 = 0.962877 \cdot 369.9 = 356.1681 MW \quad (10)$$

$$CG_5 = 20 MW \quad (11)$$

The relative contribution in the load and outflow of common 5:

$$CG_1 = \frac{13.73188}{13.73188 + 356.1681 + 20} = 0.035219 p.u. \quad (12)$$

$$CG_2 = \frac{356.1681}{13.73188 + 356.1681 + 20} = 0.913486 p.u. \quad (13)$$

$$CG_5 = \frac{20}{13.73188 + 356.1681 + 20} = 0.051295 p.u. \quad (14)$$

The absolute contribution in the inflow of common 4:

$$CG_1 = 1 \cdot 85.3 = 85.3 MW \quad (15)$$

$$CG_4 = 20 MW \quad (16)$$

The relative contributions in the load and outflow of common 4:

$$CG_1 = \frac{85.3}{85.3 + 20} = 0.630451 p.u. \quad (17)$$

$$CG_4 = \frac{20}{85.3 + 20} = 0.369549 p.u. \quad (18)$$

The absolute contributions in the inflow of common 3:

$$CG_1 = 0.630451 \cdot 15.3 = 9.645898 MW \quad (19)$$

$$CG_4 = 0.369549 \cdot 15.3 = 5.654102 MW \quad (20)$$

$$CG_3 = 680.85 MW \quad (21)$$

Verifying the participations for generators 1 and 4 in the power flow on branch 12-11, respectively 18-20.

$$CG_1 = \frac{9.645898}{9.645898 + 5.654102} = 0.6305 p.u. \quad (22)$$

$$CG_4 = \frac{5.654102}{9.645898 + 5.654102} = 0.3695 p.u. \quad (23)$$

$$\text{Branch 12-11: } CG_1 = 0.6305 \cdot 9.5 = 5.98928 MW \quad (24)$$

$$CG_4 = 0.3695 \cdot 9.5 = 3.51072 MW \quad (25)$$

$$\text{Branch 18-20: } CG_1 = 0.6305 \cdot 5.8 = 3.65661 MW \quad (26)$$

$$CG_4 = 0.3695 \cdot 5.8 = 2.14339 MW \quad (27)$$

The relative contributions to the load and outflow of common 3:

$$CG_1 = \frac{9.645898}{9.645898 + 5.654102 + 680.85} = 0.013856 p.u. \quad (28)$$

$$CG_4 = \frac{5.654102}{9.645898 + 5.654102 + 680.85} = 0.008122 p.u. \quad (29)$$

$$CG_3 = \frac{680.85}{9.645898 + 5.654102 + 680.85} = 0.978022 p.u. \quad (30)$$

The absolute contributions to the inflow of common 6:

$$CG_1 = 0.013856 \cdot 162.1 + 0.035219 \cdot 240.9 = 10.73032 MW \quad (31)$$

$$CG_4 = 0.008122 \cdot 162.1 = 1.31657 MW \quad (32)$$

$$CG_3 = 0.978022 \cdot 162.1 = 158.5374 MW \quad (33)$$

$$CG_2 = 0.913486 \cdot 240.9 = 220.0587 MW \quad (34)$$

$$CG_5 = 0.051295 \cdot 240.9 = 12.35701 MW \quad (35)$$

$$CG_6 = 4 MW \quad (36)$$

Using the concept described above, the participations of the 1, 4, 3, 2 and 5 generators in the active power flow on the 11-13, 11-14 and 15-13 branches have been calculated (Table V).

TABLE V  
CHECKING THE PARTICIPATION TO SOME SYSTEM BRANCHES

Generating unit	Branch		
	11-13	11-14	15-13
G1	0.80919	1.44	8.48425
G4	0.47432	0.84	
G3	57.1165	101	
G2			220.059
G5			12.357

In what follows, the contribution of each generator in the active power flow of system will be computed [6]. In order to calculate the transfer cost by the MW-km method, the

following formula will be used [7], [9]:

$$TC_t = \frac{\sum_{k \in t} CL_k P_k}{P_{G_t}} [\$/MW] \tag{37}$$

where:  $TC_t$  represents the specific flow cost for the  $t$  transaction;  
 $c$  – the specific cost in  $\$/MWkm$ ;  $L_k$  – the length of the  $k$  line in

km;  $P_k$  – the transfer power on the  $k$  line;  $P_{G_t}$  – the power produced by the source of the  $t$  transaction. As for the specific cost, the authors used a value for  $c = 2\$/MWkm$ .

The final results can be studied in Table VI.

TABLE VI  
 GENERATION CONTRIBUTION TO ACTIVE POWER FLOW ON SYSTEM BRANCHES

Fr Nr	To Nr	G1	G2	G3	G4	G5	G6	
1	7	227887.81	0.00	0.00	0.00	0.00	0.00	
7	9	147454.65	0.00	0.00	0.00	0.00	0.00	
2	10	0.00	25163.70	0.00	0.00	0.00	0.00	
10	8	0.00	149654.55	0.00	0.00	0.00	0.00	
7	8	0.00	13948.92	0.00	0.00	0.00	0.00	
17	19	23.76	0.00	2383.21	13.93	0.00	0.00	
17	20	15.00	0.00	1504.21	8.79	0.00	0.00	
3	11	0.00	0.00	34289.86	0.00	0.00	0.00	
12	11	1126.66	0.00	0.00	660.41	0.00	0.00	
11	17	68.57	0.00	6878.33	40.19	0.00	0.00	
4	18	0.00	0.00	0.00	6753.88	0.00	0.00	
9	12	14652.16	0.00	0.00	0.00	0.00	0.00	
12	18	10988.00	0.00	0.00	0.00	0.00	0.00	
11	13	220.33	0.00	15552.02	129.15	0.00	0.00	
15	13	644.62	16719.71	0.00	0.00	938.87	0.00	
6	13	0.00	0.00	0.00	0.00	0.00	2201.39	
11	14	333.47	0.00	23537.80	195.47	0.00	0.00	
13	14	237.72	5628.91	1460.99	12.13	316.08	0.00	
23	25	34.47	894.01	0.00	0.00	0.00	0.00	
23	24	14.34	372.02	0.00	0.00	0.00	0.00	
10	15	3344.83	86755.92	0.00	0.00	0.00	0.00	
15	23	435.89	11305.90	0.00	0.00	0.00	0.00	
15	16	113.78	2951.23	0.00	0.00	0.00	0.00	
22	21	14.27	370.10	0.00	0.00	0.00	0.00	
16	22	258.31	6699.79	0.00	0.00	0.00	0.00	
20	19	114.79	0.00	710.41	67.28	0.00	0.00	
18	20	627.14	0.00	0.00	367.61	0.00	0.00	
5	21	0.00	0.00	0.00	0.00	496.75	0.00	
21	25	14.11	365.86	0.00	0.00	584.56	0.00	
Total		408624.664	320830.6289	86316.81269	8248.8463	2336.26	2201.38535	828558.6
TC		2436.01806	1912.633468	514.5781293	49.17554	13.9276	13.1235702	
Participation price		3.42387427	1.83434368	0.755787808	0.9835108	0.69638	3.28089256	

B. Case 2

According to the structure of the analyzed test system and to the principles stated above, the commons will be defined as presented in Table VII.

TABLE VII  
 DEFINITIONS OF ANALYZED SYSTEM COMMONS

Nr. zone	Component buses	Input power [MW]	Output power [MW]
1	1, 7, 9, 12	711.48	586
2	2, 8, 10, 15	1042.68	713
3	3, 11, 17, 19	680.85	112
4	4, 18, 20	50	142
	5, 16, 21, 22,	20	149
5	23, 24, 25		
6	6, 14, 13	4	407

Table VIII contains the definitions of the links between the commons.

Fig. 3 offers the acyclic graph, which express the links between the commons of the analyzed test system, according to case 2.

TABLE VIII  
 DEFINITIONS OF ANALYZED SYSTEM LINKS

From	To	Branch	Value [MW]
1	2	7_8	40.2
2	5	15_23,15_16	129
2	6	15_13	240.9
1	4	12_18	75.8
4	3	20_19	8.3
3	6	11_13, 11_14	162.1
1	3	12_11	9.5
3	4	17_20	24.5

TABLE IX  
PARTICIPATION PRICE FOR CASE 2

	G1	G2	G3	G4	G5	G6	
Total	420472.698	361513.0963	35778.91976	7511.1848	1081.31	2201.38535	828558.6
TC	2506.65019	2155.16221	213.2962168	44.777968	6.44622	13.1235702	
Participation price	3.52314919	2.066944997	0.313279308	0.8955594	0.32231	3.28089256	

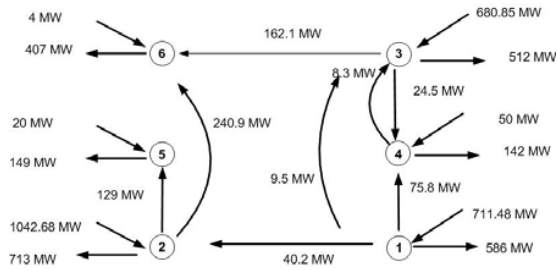

Fig. 3 State graph for case 2

C. Case 3

According to the structure of the analyzed test system and to the principles stated above, the commons will be defined as presented in Table X.

TABLE X  
DEFINITIONS OF ANALYZED SYSTEM COMMONS

Zone nr.	Component buses	Input power [MW]	Output power [MW]
1	1, 7, 9, 12	711.48	586
2	2, 8, 10, 15, 16, 23, 24	1042.68	783
3	3, 11, 17, 14	680.85	717
4	4, 18, 20, 19	50	174
5	5, 21, 22, 25	20	79
6	6, 13	4	170

Table XI offers the definitions of the links between the commons.

TABLE XI  
DEFINITIONS OF ANALYZED SYSTEM LINKS

From	To	Branch	Value [MW]
1	2	7_8	40.2
2	5	23_25,16_22	59
2	6	15_13	240.9
1	4	12_18	75.8
3	4	17_19,17_20	48.2
6	3	13_14	133.3
1	3	12_11	9.5
3	6	11_13	58.4

Fig. 4 contains the acyclic graph, which expresses the links between the commons of the analyzed test system, according to case 3.

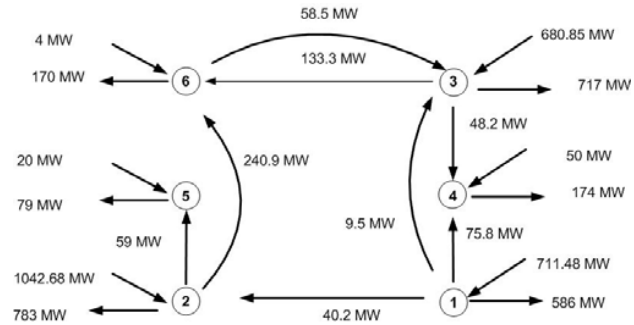

Fig. 4 State graph for case 3

TABLE XII  
PARTICIPATION PRICE FOR CASE 3

	G1	G2	G3	G4	G5	G6	
Total	527439.399	210770.4355	79676.49156	7217.1496	1081.31	2373.05843	828557.8
TC	3144.33558	1256.510189	474.9922502	43.025114	6.44623	14.147013	
Participation price	4.41942933	1.205077482	0.697645958	0.8605023	0.32231	3.53675326	

D. Case 4

TABLE XIII  
DEFINITIONS OF ANALYZED SYSTEM COMMONS

Nr.	Component buses	Input power [MW]	Output power [MW]
1	1, 7, 9, 12	711.48	586
2	2, 8, 10, 15, 16, 22, 23, 24	1042.68	818
3	3, 11, 13, 14, 17	680.85	887
4	4, 18, 20, 19	50	174
5	5, 21, 25	20	44
6	6	4	0

TABLE XIV  
DEFINITIONS OF ANALYZED SYSTEM LINKS

From	To	Branch	Value [MW]
1	2	7_8	40.2
4	3	11_12	9.5
3	4	17_19,17_20	48.2
1	4	9_12	85.3
2	5	22_21,23_25	24
6	3	6_13	4
2	3	15_13	240.9

According to the structured of analyzed test system and to the principles stated above, the commons will be defined as

presented in Table XIII.

Table XIV contains the definitions of the links between the commons.

Fig. 5 presents the acyclic graph, which expresses the links between the commons of the analyzed test system, according to case 4.

In what follows, a series of graphical representations of various costs, using the data from Table VI, IX, XIII and XV, will be drawn.

Fig. 6 offers a 3D representation of the total cost for each generator, using all four analyzed variants.

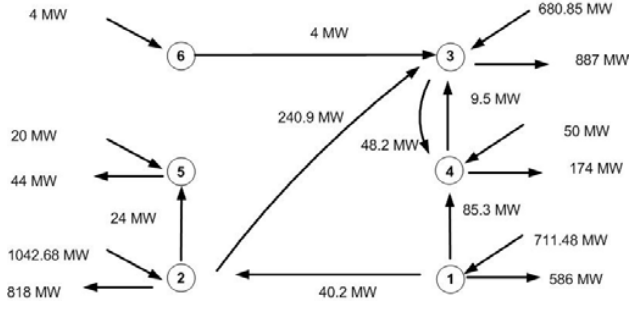

Fig. 5 State graph for case 4

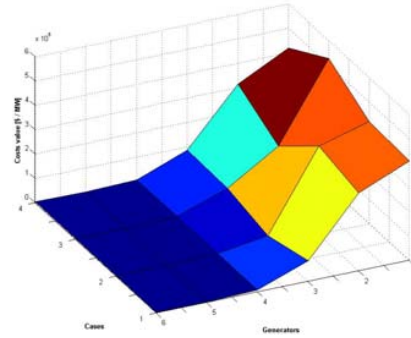

Fig. 6 Total cost representation

TABLE XV  
PARTICIPATION PRICE FOR CASE 4

	G1	G2	G3	G4	G5	G6	
Total	418281.6105	314354.7091	85384.9224	7234.681749	1081.307885	2221.360867	828558.5926
TC	2493.588004	1874.027239	509.0226604	43.129593	6.446222601	13.2426544	
Participation price	3.504790021	1.797317719	0.747628201	0.86259186	0.32231113	3.3106636	

In Fig. 7 the specific cost for transactions is presented. As input data the specific cost of transfer for transactions for each generator and in all four analyzed cases has been taken into consideration.

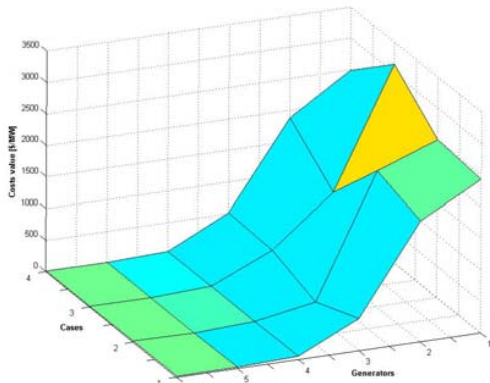

Fig. 7 Specific cost representation of transfer for transactions

In Fig. 8 the participation cost for each generator in all four analyzed cases is presented.

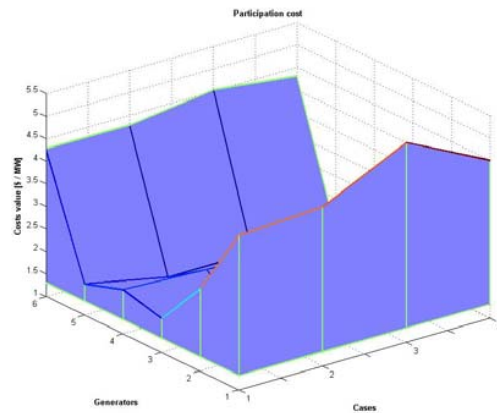

Fig. 8 Participation cost representation

IV. CONCLUSION

The specific cost of the sources is not decisive for the optimal state of the system, the allocation being tackled from a different point of view. It must be punctuated that for all four chosen cases of commons, the occasional transmission costs are practically identical. There is the possibility of decision according to the common structure based on the acyclic graph. The Kirschen method is suitable to estimate the performance of the system, even if the definition of the commons depends on the system operators.

## REFERENCES

- [1] M. Shahidelpour, H. Yahim, Z. Li, „Market Operations in Electric Power Systems. Forecasting, Scheduling and Risk Management”, in *A John Wiley & Sons, INC, 2002.*
- [2] G. Strbac, D. Kirschen, S. Almed, „Allocating Transmission System Usage on the Basis of Traceable Contributions of Generators and Loads to Flow”, *IEEE Transactions on Power System*, Vol. 13, No. 2, May 1998, pp. 527-534.
- [3] D. Kirschen, G. Strbac, „Tracing Active and Reactive Power between Generators and Load Using Real and Imaginary Currents”, *IEEE Transactions on Power System*, Vol. 14, No. 4, November 1999, pp. 1212-1319.
- [4] D. Kirschen, R. Allan, G. Strbac, “Contributions of Individual Generators to Loads and Flow”, *IEEE Transactions on Power System*, Vol. 12, No. 1, February 1997, pp. 52-66.
- [5] Barbulescu C., Vuc Gh., Kilyeni St., “Probabilistic Load Modelling Influences on the Load Flow. Case Study TEST25 Test Power System”, *Proceedings of the International Youth Conference on Energetics (IYCE) 2007*, 31.V-02.VI.2007, Budapest, Hungary, ISBN: 978-963-420-908-9, pag. 175.
- [6] J. Bialek, „Topological Generation and Load Distribution Factors for Supplement Charge Allocation in Transmission Open Access”, *IEEE Transactions on Power System*, Vol. 12, No. 3, August 1997, pp. 1185-1193.
- [7] O. Pop, M. Nemes, „Power System Allocation with Network Matrices”, *Proceeding of the 7<sup>th</sup> International Power Systems Conference*, November 22-23, 2007, Timisoara, Romania, pp. 527-534.
- [8] M. Ilic, F. Galiana, L. Fink, „Power System Restructuring: Engineering and Economics”, in Norwell, MA: Kluwer, 1998.
- [9] H.H. Happ, “Cost of Wheeling Methodologies”, *IEEE Transactions on Power System*, Vol. 9, No. 1, February 1995, pp. 147-156.